

# COUNTRY ROADS BOARD

VICTORIA

1971



## FIFTY-EIGHTH ANNUAL REPORT

FOR YEAR ENDED 30TH JUNE, 1971

PRESENTED TO BOTH HOUSES OF PARLIAMENT

PURSUANT TO ACT No. 6229

*By Authority:*

C. H. RIXON, GOVERNMENT PRINTER, MELBOURNE



# COUNTRY ROADS BOARD

<i>Chairman</i>	..	..	..	..	<b>I. J. O'Donnell</b>
<i>Deputy Chairman</i>	..	..	..	..	<b>R. E. V. Donaldson</b>
<i>Member</i>	..	..	..	..	<b>J. D. Thorpe</b>

## PRINCIPAL OFFICERS AS AT 30TH JUNE, 1971 HEAD OFFICE

<i>Chief Engineer</i>	..	..	..	..	<b>T. H. Russell</b>
<i>Secretary</i>	..	..	..	..	<b>N. L. Allanson</b>
<i>Accountant</i>	..	..	..	..	<b>R. G. Cooper</b>
<i>Deputy Chief Engineer</i>	..	..	..	..	<b>W. S. Brake</b>
<i>Deputy Secretary</i>	..	..	..	..	<b>C. C. Liddell</b>
<i>Deputy Accountant</i>	..	..	..	..	<b>R. J. C. Bulman</b>

## DIVISIONAL OFFICES

<i>Division</i>					<i>Divisional Engineer</i>
Bairnsdale	..	..	..	..	<b>W. H. Dolamore</b>
Ballarat	..	..	..	..	<b>E. T. Oppy</b>
Benalla	..	..	..	..	<b>R. R. Patterson</b>
Bendigo	..	..	..	..	<b>T. M. Glazebrook</b>
Dandenong	..	..	..	..	<b>F. W. Docking</b>
Geelong	..	..	..	..	<b>G. W. Marshallsea</b>
Horsham	..	..	..	..	<b>J. W. Heid</b>
Metropolitan	..	..	..	..	<b>L. M. Jones</b>
Traralgon	..	..	..	..	<b>A. Jacka</b>
Warrnambool	..	..	..	..	<b>F. G. Lodge</b>



60 Denmark Street  
Kew  
1st November 1971

*The Honorable A. J. Hunt, M.L.C.*

*Minister for Local Government*

*61 Spring Street*

*Melbourne 3000*

Sir,

In accordance with the requirements of Section 128 of the Country Roads Act 1958, No. 6229, the Board has the honour to submit to you for presentation to Parliament the report of its proceedings for the year ended 30th June, 1971.

The Board thanks you, Sir, for your support and interest in its activities and wishes to place on record its appreciation of the continued co-operation and assistance of other State Ministers, Government Departments, State instrumentalities and municipal councils.

The Board also pays tribute to the continued loyal co-operation and work done by its staff and employees throughout the year.

We have the honour to be,

Sir,

your obedient servants

R. E. V. DONALDSON, A.A.S.A. (Senior),  
A.I.M.A., F.C.I.T., J.P.,  
Chairman.

J. D. THORPE, C.E., F.I.E. Aust.,  
M.I.T.E. (U.S.),  
Deputy Chairman.

T. H. RUSSELL, M.Eng.Sc., B.C.E.,  
Dip. C.E., C.E., F.I.E. Aust.,  
Member.

N. L. ALLANSON, A.A.S.A. (Senior), J.P.,  
Secretary.





**During 1970/71 the Board:**

- **Expended \$72,211,284 on new roads and bridges and the maintenance and improvement of existing roads and bridges.**
- **Expended \$5,000,000 on the acquisition of land for road purposes.**
- **Constructed 33 miles of additional dual carriageways.**
- **Sealed or resealed with bitumen 3,250 miles of road.**
- **Commenced the construction of 166 new bridges.**
- **Planted 70,000 trees and shrubs on road reserves.**
- **Allocated \$50,180,000 for expenditure by municipalities on main and unclassified roads.**



# ANNUAL REPORT 1970/71

## REVIEW

### MELBOURNE METROPOLITAN PLANNING AREA

Roads are constructed to provide a service to all sections of the community. While great improvements to the road network have been made in recent years the level of service provided at present could not be regarded as anywhere near the optimum. Many more improvements need to be effected as part of a planned road programme.

The need for improved road standards is nowhere more evident than in the Melbourne Metropolitan Planning Area of 1,942 square miles. The Victorian Road Needs Survey 1969-1979 conducted by the Board in conjunction with municipal councils and the Commonwealth Bureau of Roads disclosed that the backlog of road needs at 1st July, 1969, in the Melbourne Metropolitan Planning Area was \$696M. By 30th June, 1974, the accumulated backlog is increasing each year.

The Commonwealth Aid Roads Act 1969 recognized the need for additional finance to be devoted to the construction and reconstruction of urban arterial roads in the Melbourne Statistical Division and the urban areas of Ballarat, Bendigo and Geelong. The Melbourne Statistical Division of 2368 square miles includes the Melbourne Metropolitan Planning Area plus an area of Healesville Shire and the whole of the Mornington Peninsula south of Baxter. The Commonwealth Aid Roads Act specifies that \$156M or 61.3% of the funds provided under the Act for expenditure in Victoria for five years from 1st July, 1969, shall be spent on the construction and reconstruction of urban arterial roads.

The Board is directly responsible for 174 miles of State highways, 14 miles of tourists' roads and 34 miles of freeways and shares responsibility with municipal councils for 604 miles of main roads in the Planning Area.

Expenditure from the Board's funds and the Roads (Special Projects) Fund in the Planning Area in financial year 1970/71 was \$28,346,000 representing 35.4% of the Board's total road expenditure throughout the State.

Details of the Board's expenditure in the Melbourne Metropolitan Planning Area over the last ten years are shown below:

Year ended 30th June	Old area of 688 sq. miles			New area (as from 1/7/68) of 1,942 sq. miles		
	Board's Funds \$	Special Projects Fund \$	% of Board's Total Road Expenditure	Board's Funds \$	Special Projects Fund \$	% of Board's Total Road Expenditure
1962	7,864,000	—	18.6%	—	—	—
1963	6,880,000	—	17.6%	—	—	—
1964	10,380,000	—	21.1%	—	—	—
1965	12,066,000	—	23.8%	—	—	—
1966	12,183,000	1,654,000	26.1%	—	—	—
1967	12,653,000	3,311,000	27.8%	—	—	—
1968	16,186,000	2,652,000	30.8%	—	—	—
1969	—	—	—	22,053,000	1,607,000	36.5%
1970	—	—	—	26,730,000	555,000	37.0%
1971	—	—	—	25,696,000	2,650,000	35.6%

The above expenditure has been incurred on a great variety of effective works including the construction of modern freeways, conversion of single carriageway roads to dual carriageways, replacement of railway level crossings by overpasses or underpasses, widening pavements, channelized intersections and improvements to road markings and direction signs.

The Board is conscious of the need for new roads in the form of freeways, in the built-up areas of the planning area to be strategically located to form a valuable part of a well balanced transport service to the community.

As referred to in more detail on pages 2, 3 & 4 of this report the Board is already proceeding with the construction or detailed planning for the construction of the Mulgrave Freeway, Eumemmerring Freeway, Mornington Peninsula Freeway, Frankston Freeway, Calder Freeway, all of which are located in the planning area and which affect built up areas. The general routes of such freeways conform with the recommendations of the Metropolitan Transportation Plan, while the detailed alignments selected take into account the provisions of the Melbourne Metropolitan Planning Scheme, the requirements of other service authorities and in particular the views of the municipal councils concerned. The satisfaction of the needs of local communities is a prime consideration in the determination of freeway routes.

## **FREEWAYS AND DUAL CARRIAGEWAY ROADS**

During the year the Board completed the construction of nine miles of new freeways and converted twenty miles of single carriageway State highways to dual carriageway roads. Approximately four miles of declared main roads were also converted to dual carriageway roads by municipal councils with financial assistance from the Board. This brings the total mileage of dual carriageways on declared roads to 264 miles, compared with 159 miles at 30th June, 1966.

Detailed planning proceeded for an additional 33 miles of new freeways. The more important dual carriageway projects completed, commenced, in progress or in the planning stage during the year are briefly described below:

### **Lower Yarra Freeway**

On 7th April, 1971, the Lower Yarra Freeway was opened to traffic from the Princes Highway near Kororoit Creek to Williamstown Road. The four miles of divided freeway will serve as the western approach road to the West Gate Bridge project. Approximately 10,000 vehicles used the freeway each week day in June, 1971, between 7 a.m. and 7 p.m. Built at a cost of \$14M, the freeway involved the construction of twelve road traffic bridges and two pedestrian overpass bridges. Further details on this project appear on page 19.



*The Lower Yarra Freeway at the twin bridges over the Newport-Sunshine railway.*

### **Mulgrave Freeway and Eumemmerring Freeway**

Work continued on the construction of 3.9 miles of dual carriageways of the Mulgrave Freeway and the Eumemmerring Freeway from just west of Stud Road, Dandenong North, to the Princes Highway at Hallam. Interchanges are being constructed at Stud Road, Heather-ton Road and the Princes Highway. The work is expected to be completed in the second half of 1972 at a cost of approximately \$6.5M.



*The Mulgrave Freeway under construction at Heather-ton Road.*

The construction of a further section of 4½ miles of the Mulgrave Freeway from Springvale Road to west of Stud Road commenced during the year. All road and bridge work is being carried out under a contract amounting to approximately \$7M, the largest contract ever let by the Board. This section of the freeway is expected to be completed during 1974/75 at a cost of approximately \$8.5M.

Detailed design and land acquisition is proceeding for a third section of the Mulgrave Freeway which will extend from Springvale Road to the vicinity of Waverley Road, Chadstone. When this third section is completed in 1976, 13½ miles of freeway from the vicinity of Waverley Road, Chadstone to the Princes Highway at Hallam will be available for traffic.

### **Mornington Peninsula Freeway**

The construction of five miles of four-lane freeway from the Nepean Highway, Dromana to Eastbourne Road near Rosebud continued during the year. At the close of the financial year pavement materials for the main carriageways were being laid on the first 1½ miles between the Nepean Highway, Dromana, and Tennent Street. Earthworks were proceeding on the adjoining 1½ mile section to Rudduck Street. Construction work on the remainder of the freeway to Eastbourne Road will commence during the 1971/72 financial year, and the whole project is expected to be completed by the end of 1973 at an estimated cost of \$5.7 million.

The full length of the completed Mornington Peninsula Freeway will extend from the Dingley Freeway at Keysborough to Canterbury Jetty Road south of Sorrento, a distance of approximately 43 miles.

### **Frankston Freeway**

In December, 1970, the second carriageway of the Frankston Freeway between Wells Road near Klauer Street and the Frankston-Cranbourne Road, a distance of two miles, was opened to traffic with exception of the overpass over Dandenong-Frankston Road. Work progressed satisfactorily on the pedestrian overpasses at Skye Road and Jubilee Avenue and the dual road bridges over the Dandenong-Frankston Road.

The extension of the Frankston Freeway northward along Wells Road for a further 1½ miles is planned for completion in 1973/74, when a total of 3½ miles of freeway will be available at an estimated cost of \$5 million.

### **Western Freeway**

Work continued during the year on the construction of the Gordon section and the Bacchus Marsh section of the Western Freeway.

The 5.8 miles long Bacchus Marsh section will by-pass the township of Bacchus Marsh to the north, leaving the existing Western Highway at Coimadai Creek and rejoining the highway at Korkuperrimul Creek. This project is expected to be completed early in 1972 at an estimated cost of \$4.0M.

The Gordon section of the freeway will by-pass Gordon township to the north of the present Western Highway, eliminating a poorly aligned section of the highway and reducing the present route length by almost one mile. The estimated cost of this 5.7 miles of freeway is \$2.1M, and should be opened to traffic towards the end of March, 1972.



*Construction of the Western Freeway (Bacchus Marsh section).*

Detailed design is well advanced for the Pentland Hills section (four miles), the Myrning section (three miles), and the Ballan section (five miles) of the Western Freeway. Construction of the Pentland Hills section will commence during the 1971/72 financial year.

The completion of the two sections under construction and the three sections now being designed will provide dual carriageways for a distance of 48.3 miles between Melbourne and Ballarat.

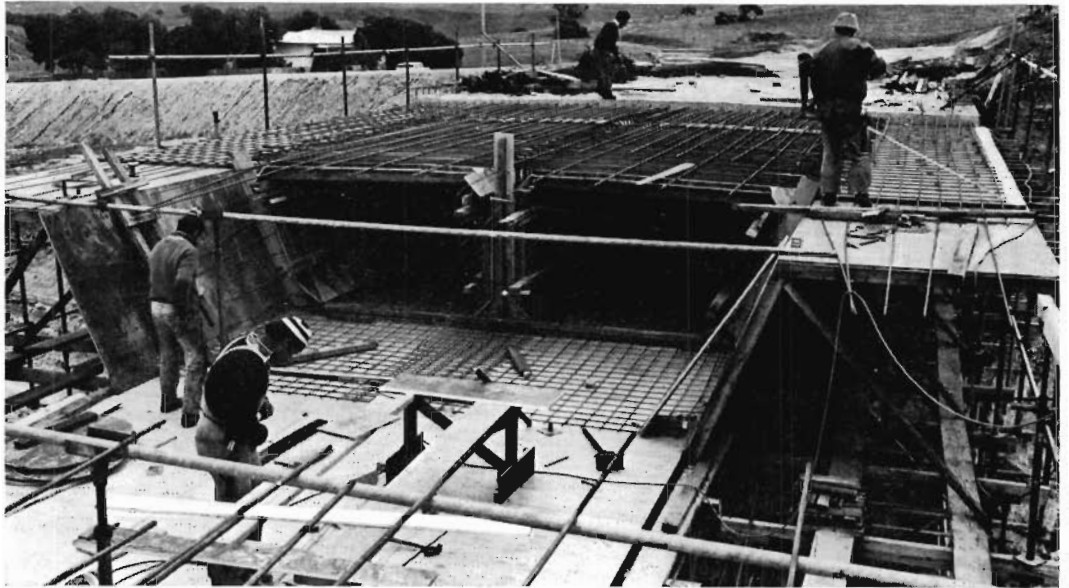

*Construction of the Condons Lane bridge over the Western Freeway (Bacchus Marsh section).*



*The Western Freeway (Gordon Section) under construction.*

### **Calder Freeway**

The construction of the main carriageways of a new six-lane freeway connection between the existing freeway route to Tullamarine Airport at the south-western corner of Essendon Airport and the existing Calder Highway at Niddrie was commenced during the year. The Board had earlier carried out the necessary excavation and earthworks for the freeway connection and had constructed an overpass bridge at Grange Road and Matthews Avenue and a tramway overpass bridge adjacent to the Matthews Avenue Bridge. The total estimated cost of the project is \$2.3M. The new freeway connection will be completed during the 1971/72 financial year.

### **Hume Freeway**

Plans for the construction of a 22 mile freeway standard deviation of the Hume Highway between Wallan and Broadford were released during the year.

Tenders were invited for the supply and erection of 27,170 lineal feet of fencing of the freeway between Beveridge and Wallan East with a view to construction works on this section commencing during the 1971/72 financial year.

Survey, land acquisition, and detailed design proceeded for the remainder of the freeway north of Wallan East. The four-lane freeway is expected to be opened to traffic in 1974/75 at an estimated cost of \$14 million.

The Hume Freeway (Tallarook Section) of 3.4 miles was completed during the financial year. The freeway enables traffic to avoid using the poorly aligned section of the Hume Highway through Tallarook. Interchanges are located both south and north of Tallarook to give access to the township. The construction works included six bridge structures, two at each interchange and twin bridges over the Melbourne-Sydney railway line.

### **Freeway F2**

During the year the Board investigated the route of some 16 miles of freeway from Craigieburn south through Coburg, Brunswick, and Northcote generally following the Melbourne Metropolitan Planning Scheme reservation and the freeway corridor for Route F2 in the Metropolitan Transportation Plan.

Preliminary layout plans for the 12 mile section from Craigieburn to Bell Street are well advanced.

### **Princes Highway West**

The replacement of the old four-lane road over rail bridge at West Footscray commenced in June, 1970. A new six-lane bridge and major improvements to several highway inter-sections either side of the railway line will improve the flow of through traffic and assist cross movements by local traffic when completed in 1973.

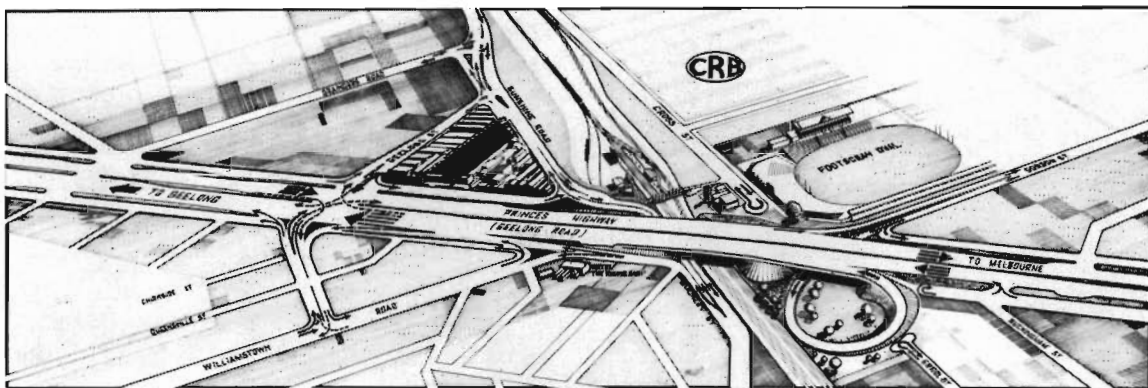

*Schematic drawing of the West Footscray project when completed.*

Work commenced on the construction of 1.1 miles of dual carriageways each 44 feet wide between Bell Parade and Latrobe Terrace, Geelong.

In South Barwon Shire 2.4 miles of dual carriageways between Settlement Road and Waurn Ponds Creek were completed. A second bridge over Waurn Ponds Creek will be constructed during 1971/72.

### **Maroondah Highway**

A further length of 2.2 miles of dual carriageways on the Maroondah Highway between Brushy Creek, North Croydon, and Hull Road, Lilydale, was opened to traffic during the year. Thirteen miles of continuous dual carriageways are now available to traffic east of Box Hill.

### **Burwood Highway**

The construction of a further 2.3 miles of dual carriageways from just east of Stud Road to Ferntree Gully Road commenced during the year. The existing 24 feet wide single pavement is being replaced by two carriageways each 24 feet wide separated by a median 21 feet wide. The work will be completed during the 1971/72 financial year at an estimated cost of \$700,000.

### **Princes Highway East**

The construction of the highway between Castlebar Road and Ferntree Gully Road, Oakleigh, to provide six lanes for through traffic was completed. This work included major improvements at the highway intersection with Warrigal Road.

Work also commenced on the provision of 1½ miles of dual carriageways from Repton Road, Caulfield East, to Poath Road, Chadstone.



## Nepean Highway

An additional length of three-quarters of a mile of dual carriageways each of three lanes was completed between the Moorabbin Overpass and Wickham Road.

Between Tower Road and Dava Drive, Mornington, the construction of 3.4 miles of dual carriageways continued. The work was almost completed at the close of the financial year.

Work also commenced on the construction of dual three-lane carriageways between Lower Dandenong Road, Mentone, and White Street, Mordialloc, a distance of 1¼ miles.

## REQUESTS FOR EXPANSION OF DECLARED ROAD SYSTEM

During the financial year the Board continued to receive requests from municipal councils for roads to be declared or proclaimed under the provisions of the Country Roads Act and for roads declared as main roads under the Country Roads Act to be reclassified and declared as State highways.

The Board would like to be in a position to extend the length of the declared road system but cannot accept the additional financial responsibility which would be involved.

The length of the Board's declared road system has not changed significantly since 1948. The road standards on the declared road system however have changed dramatically. The Board considers that its responsibility to the community is more effectively being carried out by the prosecution of a planned programme of development of the existing declared road system. This is evidenced by the increased length of dual carriageways and sealed pavements, wider pavements, wider and stronger bridges, the elimination of railway level crossings, the construction of pedestrian overpasses, the improvement of major intersections and the application of traffic engineering safety factors.

The Board continued its practice of making allocations for councils' unclassified roads in accordance with nominated priorities and available funds.

The following table indicates how the surface standards of each type of road declared or proclaimed under the provisions of the Country Roads Act have been improved in the twenty year period from 1950 to 1970:

	Year Ended 30th June	Bituminous Seal or Higher Grade	Paved Only	Formed Only	Unformed but Trafficked	Total
		Miles	Miles	Miles	Miles	Miles
STATE HIGHWAYS	1950	2,828	985	37	—	3,850
	1960	3,380	464	—	1	3,845
	1970	4,258	182	—	—	4,440
FREEWAYS	1950	—	—	—	—	—
	1960	—	—	—	—	—
	1970	66	—	—	—	66
TOURISTS' ROADS	1950	108	319	5	—	432
	1960	171	245	1	—	417
	1970	306	177	—	—	483
FOREST ROADS	1950	38	308	10	—	356
	1960	87	289	2	—	378
	1970	245	332	—	—	577
MAIN ROADS	1950	3,731	5,711	305	53	9,800
	1960	6,681	2,970	96	4	9,751
	1970	8,250	788	28	—	9,066
TOTAL DECLARED ROADS	1950	6,705	7,323	357	53	14,438
	1960	10,319	3,968	99	5	14,391
	1970	13,126	1,479	28	—	14,633

## ROADS TO SNOW RESORTS

The Board is directly responsible for the Mount Buller Tourists' Road, the Mount Buffalo Tourists' Road, the Alpine Tourists' Road, and the Bogong High Plains Tourists' Road, all of which provide access to the major Victorian snow fields.

Each year during the warmer months between winters the opportunity is taken to implement a programme of improvements to these roads. During the 1970/71 construction season the following improvements were effected:—

### Alpine Tourists' Road

0.6 mile of the road across the precipitous face of Mount Blowhard was widened from 18 feet to 28 feet. At Hotham Heights an experimental section of sealed pavement was constructed to test its effectiveness in the heavy frost conditions encountered in that area.

The seal extends for 0.4 mile from Jack's Tow to the Hotham Heights Hotel entrance. On the approach from Omeo the Alpine Road was reconstructed, widened and realigned for 1¼ miles near Jim and Jack Creek, and a length of five miles between Dinner Plain and Slatey Cutting was resurfaced with crushed rock.



*Widening of the Alpine Tourists' Road at Mount Blowhard.*

### **Bogong High Plains Tourists' Road**

A length of  $1\frac{1}{2}$  miles of the road at Falls Creek was sealed, part of the width of 31 feet being provided for parking at the cost of the Falls Creek Committee of Management.

### **Mount Buffalo Tourists' Road**

On the Mount Buffalo plateau a section 2.7 miles long was resurfaced between Dingo Dell and Cresta. From Dingo Dell to Cathedral car park, a distance of 1.7 miles, the road was widened from 18 feet to 25 feet.

### **Mount Buller Tourists' Road**

A further 2.75 miles section of the road was sealed during the year, and unsealed sections were resurfaced with gravel. Two miles of widening and curve improvement work was also carried out.

Vehicular access to the snow resorts was maintained by the Board during the 1971 winter. Snow clearing plant in use on these roads consists of power graders with blades modified for the purpose of clearing light snow falls and imported turbo miller snow blowers which throw the snow from heavy falls clear of the road. In all, six graders, two small snow blowers, and two large snow blowers were in use during the 1971 snow season.

## **AUSTRALIAN ROADS SURVEY 1969-74**

During 1967/68 the National Association of Australian State Road Authorities, in conjunction with the Commonwealth Bureau of Roads, conducted an Australian Roads Survey which provided the major source of data for the Bureau's report to the Commonwealth Government regarding financial assistance to the States for roads. The Act under which the Commonwealth makes such assistance available to the States is the Commonwealth Aid Roads Act No. 41 of 1969.

Prior to the expiration of the current Act on 30th June, 1974, the Bureau will submit relevant reports and recommendations to the Commonwealth Government for consideration in framing similar legislation for a future period, and has requested the assistance of the National Association of Australian State Road Authorities in jointly conducting an Australian Roads Survey in respect of the period 1969 to 1974.

The Survey is being designed to provide an up to date appraisal of the physical and operational characteristics of the road system to provide an adequate level of service to the traffic using it. To ensure uniformity in the conduct of the Survey by the various Authorities, standards are being developed for the identification of deficiencies and the design of improvements.

The five main phases of the Survey will be:

- (i) the collection of inventory data on roads and bridges;
- (ii) the identification of deficiencies;
- (iii) the selection and estimated costs of improvement projects, and the preparation of maintenance estimates;
- (iv) the economic evaluation of improvement projects;
- (v) scheduling (listing of projects allowing for restrictions on finance and other resources).

The first three phases will be carried out mainly by the State Road Authorities and municipalities, and the latter two phases largely by the Commonwealth Bureau of Roads.

As a member of the National Association of Australian State Road Authorities, the Board will undertake the survey in Victoria with the assistance of local government bodies.

During the year the Board was engaged in planning the Survey in Victoria. A vehicle equipped with instruments was used to collect basic data for an inventory of the Board's declared road network.

Information on road geometry and conditions, terrain, land use and other relevant matters were recorded. At the close of the year recording on some 2,000 miles of State highways, freeways, and main roads had been completed. Work also commenced on the preparation of a standard set of maps showing all roads, railways, and municipal boundaries in Victoria which will facilitate the collection of information by the Board and municipalities.

## **TRANSPORTATION STUDIES**

During the year 1969/70 the Board initiated plans for transportation studies in the urban areas of Geelong, Ballarat and Bendigo to determine the public requirements for transportation facilities both now and in the future. The studies are being carried out by consultants supervised by a committee acting on behalf of the Board.

Field surveys to determine vehicle and passenger movements were completed early in 1971. A feature of these surveys which involved 70,000 personal interviews, was the ready co-operation of the travelling public and the residents of the areas under review.

Analysis of the survey data and the projection of travel requirements for the years 1981 and 1991 is progressing. Population and employment forecasts for each city have been prepared by specialist consultants assisting the main consultants engaged by the Board.

The studies will be completed during 1971/72 and will present for consideration, proposals for road improvements for the immediate future as well as proposals to be staged over the period to 1991.

## **LIGHTING ON STATE HIGHWAYS**

Prior to the proclamation of the Country Roads (Amendment) Act 1971, the Board had no power to expend its funds on street lighting other than on freeways. The recent Act permits the Board to expend its funds on the lighting of State Highways and provides for the Board, the electricity supply authority and the Council concerned to share the costs of street lighting on State highways where the lighting is of a standard not lower than the minimum standard to be determined by a committee known as the Street Lighting Committee.

The Street Lighting Committee consists of a representative of the State Electricity Commission, the Municipal Association of Victoria and the Country Roads Board. The three members were appointed by the Governor in Council on 8th June, 1971. The Board's representative, Mr. H. W. P. Hobbs, Deputy Chief Engineer—Road Design, is Chairman of the Committee.

Procedures to be followed in administering the new provisions are still being formulated, but the legislation makes the Board responsible for taking any action it considers necessary to install or improve lighting on State highways to a standard not lower than the standard determined by the Committee. The functions of the Committee are to determine a minimum standard of street lighting, to approve installations which meet this standard, and to resolve any problems or disputes associated with the installation, operation, or maintenance of street lighting standards.

## **MANUALS**

### **Municipal Manual**

In December, 1970, the Board published a new manual for the guidance of municipal officers on the administrative procedures and practices of the Board in its relations with municipal councils.

Titled the C.R.B. Municipal Manual, the publication includes chapters on such topics as the Board's constitution, organization and finance, the procedures and factors considered in allocating funds for road and bridge works, the administration of contracts, and the practices adopted by the Board in its dealings with municipal councils.

Copies of the Municipal Manual were forwarded to all local government bodies, and provision has been made to cater for future amendments and additions as they arise.

### **Roadside Development Manual**

During April, 1971, the Board released a new reference manual outlining the Board's practices in respect to roadside development, and emphasising the importance of conservation, preservation of the natural environment, and the development of roadside areas to achieve harmony between the road and the surrounding country.



The Roadside Development Manual of over one hundred pages includes chapters on tree, shrub, and grass planting, insect pests, erosion control, rehabilitation of areas used to obtain roadmaking materials, and the establishment of roadside stopping places. With the inclusion of many colour plates, diagrams, and tables the publication sets out in a readily accessible form the practices adopted by the Board as a result of experience gained over many years.

To stimulate interest in roadside landscaping and conservation, the Board distributed copies of the manual to all municipal councils, interested Government Departments and statutory authorities, and appropriate libraries throughout Victoria.

## **GOVERNMENT INQUIRIES**

### **Land Transport Inquiry**

During 1970, the Victorian Government appointed a Board of Inquiry to enquire into, report upon and make recommendations concerning the existing system of land transport in Victoria.

An initial comprehensive submission to the Board of Inquiry was made by the Country Roads Board outlining the road system of the State, sources of funds for roads, road needs, trends in commercial vehicle usage, special provisions to cater for commercial vehicles and the regulations controlling the weight, speed and dimensions of commercial vehicles. A second submission was made in the form of comments on the initial submissions of other interested parties which were relevant to the activities of the Country Roads Board.

Throughout the inquiry, which was still continuing at the end of the financial year, the Country Roads Board has had the opportunity to study and make comment on the submissions of other parties, and on several occasions has been asked by the Board of Inquiry for additional information to assist the inquiry.

### **Local Government Finance Inquiry**

In December, 1970, the Government appointed a Board of Inquiry into Local Government Finance in Victoria.

The terms of reference of the Board of Inquiry included the financial disabilities, if any, suffered by municipalities in the financing of works on roads and bridges.

During financial year 1970/71 the Board allocated \$50,180,000 for expenditure on main roads and unclassified roads, which are under the care and management of municipal councils. The Board of Inquiry therefore sought information from the Board on matters relating to the Board's sources of funds, the various classifications of roads for which the Board is responsible or provides financial assistance, the amount of financial assistance given by the Board to municipal councils and the bases on which the assistance is determined, the amount of the Board's expenditure in the Melbourne metropolitan area, in country cities, in towns and boroughs and in country rural areas, the merits of carrying out works by direct labour or contract, and the extent of the administrative work required of councils arising out of the Board's financial assistance. A detailed submission was presented to the Board of Inquiry.

## **TRAFFIC ACCIDENT RECORDS**

During the year the Board and the Road Safety and Traffic Authority (formerly the Traffic Commission) combined to produce data on 25,000 road accidents which occurred during 1968. The results were published by the Authority in two volumes relating to accidents in the metropolitan area and in the remainder of the State. Progress was also made with the preparation of similar volumes for 1969 accidents.

Although records of reported accidents have been available for a number of years, a new system involving the processing of information by the Board's electronic computer was designed to give the basic information in many new and different forms to assist the Board and the Authority.

The key to the new operation lies in the coding system which has been devised to convert the original report into computer language. Numerical symbols are allocated to represent the location of each accident (in any part of Victoria), the type of vehicle movements which took place, the date and time of the accident, the severity of damage to property and/or person, the prevailing conditions of light and road surface, and the type of traffic control at any intersection. The location of the accident is coded in relation to map co-ordinates, which is a more accurate method than relying on road names alone.

The final computer print-outs not only show the accident history at any particular locality, but enable groups of accident localities to be ranked in order. For instance, the intersections in a particular municipality can be shown in order of accident frequency, or the accident figures for the intersections along a particular road can be presented in mileage order. Tasks such as these are not practical with manual methods of processing.

## FLOOD DAMAGE

In February, 1971, severe flooding occurred in the East Gippsland area of the State and caused considerable damage to roads and bridges.

Following inspections by officers of the Board, the estimated cost of the required remedial works was assessed as being in the vicinity of \$630,000 for roads and structures under the control of municipal councils and \$578,000 for State highways under the control of the Board.

The urgency and standard of repair works carried out to restore access and communications reflected great credit on the municipal and Board's engineers concerned.

No special funds were made available by the State Government to the Board in financial year 1970/71 for the restoration works and the expenditure of \$401,932 incurred on the Princes Highway, Cann Valley Highway, Omeo Highway and Bonang Highway was financed from the Board's funds.

Financial assistance from the State Government is expected during financial year 1971/72 to assist in financing the cost of remedial works on main roads and unclassified roads in Orbost Shire, Rosedale Shire, Sale City, Thire, Bairnsdale Town, Maffra Shire, Omeo Shire, Alberton Shire, Avon Shire, Bairnsdale Sambo Shire and Traralgon Shire.



*Flood damage to the Cann Valley Highway 16 miles north of Cann River.*



*Bridge at Winnets Creek on the Cann Valley Highway damaged by floods.*

## CONSERVATION

There is often no alternative to removing some trees from road reserves in order to provide wider road pavements, adequate clearances and sight distances to provide for the safety of the increasing numbers of motor vehicles of all categories.

The building of modern roads and bridges sometimes requires the alteration of the natural countryside and the creation of new landscapes. Highways are designed to blend with landscape where it is pleasing or to improve visual amenities where the surrounding country is dreary.

In the interests of road safety, it is obvious that trees of appreciable size growing close to the edge of the road formation need to be removed because they constitute a hazardous physical barrier to any vehicle which runs off the road at high speed. In some cases the condition of the trees requires their removal. Where they are infected by disease, are of advanced age, in generally poor condition or interfere with the propagation of the more desirable species, removal or at least selective thinning will result in a safer, cleaner, more attractive and manageable road reserve.

Where it is possible to plant replacement trees, the Board introduces species which improve the appearance of the landscape. Trees of better shape, varied colouring or species renowned for their attractiveness of flower can often be of greater value than their predecessors.

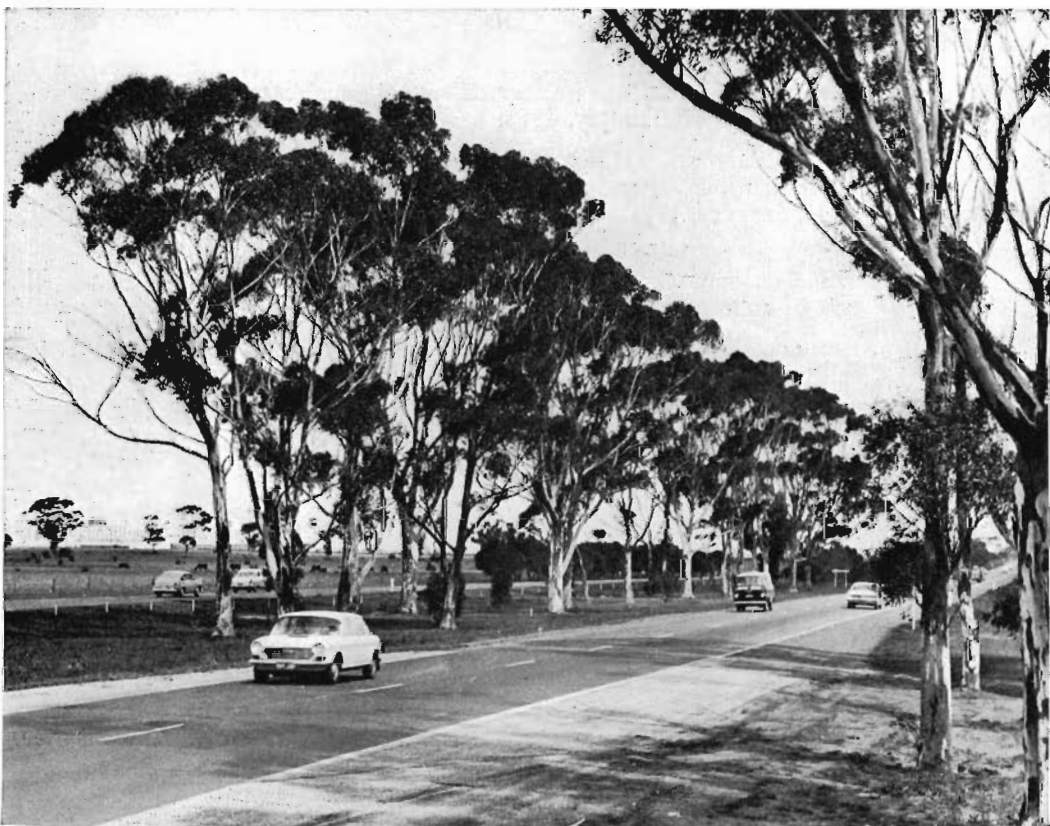

*Trees on the Princes Highway West planted by the Board many years ago.*

Over the years the Board has established many roadside plantations in areas where the landscape is almost devoid of trees. These are now valuable assets to the local environment, providing shade, shelter and visual interest. The development of medians to produce both an attractive appearance and a physical barrier to intercept headlight beams can be achieved by the planting of shrubs and small trees.

The practices of conserving existing stands of timber on road reserves and the extensive planting of trees and shrubs are high in the Board's priorities. Some 70,000 trees and shrubs were planted during financial year 1970/71.

In the Dandenong Ranges particular care has been taken to preserve as many roadside trees as possible. At two locations where the Mount Dandenong Tourists' Road was recently widened, small retaining walls were erected to protect existing native trees from the harmful effects of changed surface levels.

The Board ensures that excess material arising from road construction work is not indiscriminately spread over the surrounding countryside.

## FINANCE

The total funds available for expenditure by the Board during the year, including the allocation from the Roads (Special Projects) Fund, was \$95,916,150. This amount was \$7,599,331 or 8.6% more than the funds available in the financial year 1969/70.

The funds available were derived from:

State sources	\$53,289,912
Commonwealth Aid Roads Act	\$41,425,000
Balance brought forward from financial year 1969/70	\$1,201,238
	<u>\$95,916,150</u>

## RECEIPTS

The Board's receipts were obtained from the following main sources:

1. Fees under the Motor Car Act:
  - (a) Motor registration fees less cost of collection (metropolitan bus registration fees and the specified proportion of registration fees paid to the Roads (Special Projects) Fund are excluded).
  - (b) Two-thirds of additional motor registration fees levied on first registration and subsequent change of ownership
  - (c) Trailer registration fees less cost of collection other than the amount paid to the Roads (Special Projects) Fund.
  - (d) One-eighth drivers' licence fees less one-eighth cost of collection as from 1st January, 1971, and one-quarter drivers' licence fees less one-quarter cost of collection prior to 1st January, 1971.
  - (e) Seven-eighths drivers' licence testing fees less seven-eighths cost of collection as from 1st January, 1971, and all drivers' licence testing fees less cost of collection prior to 1st January, 1971.
  - (f) One-quarter driving instructors' licence fees less one-quarter cost of collection as from 1st January, 1971, and one half driving instructors' licence fees less one-half cost of collection prior to 1st January, 1971.
  - (g) Examiners' licence fees (motor car roadworthiness examinations) less cost of collection.
  - (h) Fees for the issue of authorised log books less cost of collection.
2. All moneys received under Part II of the Commercial Goods Vehicles Act (ton mile tax).
3. Municipal contributions to expenditure on declared main roads as provided for in the Country Roads Act.
4. Special Government Grant.
5. Small amounts of loan money.
6. Receipts under the Commonwealth Aid Roads Act.

The following table shows the receipts by the Board for the financial year 1970/71 compared with those in financial year 1969/70.

STATE SOURCES	1969/70	1970/71
Motor Car Act	\$30,868,165	\$32,894,538
Commercial Goods Vehicles Act	8,555,278	8,902,789
Municipalities Contributions	1,903,641	2,017,914
Loan Funds	900,000	388,000
Special Grant from State Treasury	849,000	782,550
General Receipts	498,345	543,336
	<u>\$43,574,429</u>	<u>\$45,529,127</u>
COMMONWEALTH AID ROADS ACT	1969/70	1970/71
Urban Arterial Roads	\$21,260,000	\$23,295,000
Rural Arterial Roads	2,420,000	2,880,000
Rural Roads other than Arterial	13,910,000	14,600,000
Planning and Research	570,000	650,000
	<u>\$38,160,000</u>	<u>\$41,425,000</u>
<b>Total</b>	<u>\$81,734,429</u>	<u>\$86,954,127</u>

## EXPENDITURE

Expenditure in the form of cash payments during the financial year 1970/71 amounted to \$88,077,365, leaving a cash balance of \$78,000 to be carried forward into the financial year 1971/72. The receipts by the Board under the Commonwealth Aid Roads Act were fully expended. The following table compares expenditure from the Board's normal funds and the Roads (Special Projects) Fund in the year 1970/71 with 1969/70.

Item	1969/70	1970/71
Construction and maintenance of roads and bridges	\$70,464,378	\$72,211,284
Capital expenditure (plant, workshops, offices, etc.)	2,436,404	2,555,432
Salaries, operating accounts and other administration expenditure	6,180,665	8,426,337
Statutory payments to Tourist Fund, Transport Regulation Fund, Road Safety and Traffic Authority Fund, etc.	1,337,163	1,439,362
Planning and Research	720,469	940,823
Interest and Sinking Fund Payments	2,443,416	2,504,127
Expenditure from Board's Normal Funds	\$83,582,495	\$88,077,365
Road and bridge expenditure from Roads (Special Projects) Fund	\$3,532,586	\$7,760,785
Total	\$87,115,081	\$95,838,150

## SHARING THE COSTS OF ROADWORKS

The Country Roads Act provides that no more than one-half of the amount expended from loan funds and one-third of the amount expended from the Country Roads Board Fund on main roads during the preceding financial year shall be apportioned between the various municipalities benefited thereby. The Act also provides that the amount apportioned to a council in respect of expenditure charged to the Country Roads Board Fund may be reduced where the cost of maintenance is excessive due to motor traffic not of local origin or to timber traffic. The revenue, valuation, and rating of the municipality and its financial obligations for loan expenditure on permanent works are taken into account in deciding the level of contribution by a council.

In September, 1970, expenditure on main roads in financial year 1969/70 was apportioned in accordance with the Country Roads Act, resulting in the following distribution of expenditure other than Loan Fund expenditure:

Expenditure from Country Roads Board Fund	\$10,741,542
Expenditure from Commonwealth Aid Roads moneys	4,390,856
Expenditure from proceeds of ton/mile tax (Commercial Goods Vehicles Act)	2,618,965
<b>TOTAL</b>	<b>\$17,751,363</b>
Amount apportioned to councils	\$1,882,571

Within the limits of funds available the Board made allocations to municipal councils for works on unclassified roads. The expenditure incurred from the allocations made by the Board in financial year 1970/71 compared with 1969/70 was as follows:

	1969/70		1970/71	
	C.R.B.	Council Contribution	C.R.B.	Council Contribution
Construction and reconstruction	\$14,318,452	\$3,525,823	\$15,134,615	\$4,032,445
Patrol Maintenance	1,732,957	808,343	1,832,503	852,345
<b>TOTALS</b>	<b>\$16,051,409</b>	<b>\$4,334,166</b>	<b>\$16,967,118</b>	<b>\$4,884,790</b>

Municipal Councils were not required to contribute towards the cost of works involving an expenditure during the year of \$35,389,499 on State highways, freeways, tourists' roads and forest roads.

## ROAD CONSTRUCTION AND MAINTENANCE

### THE DECLARED ROAD SYSTEM

The total length of roads declared or proclaimed under the Country Roads Act as at 30th June, 1971, was 14,704 miles, consisting of:

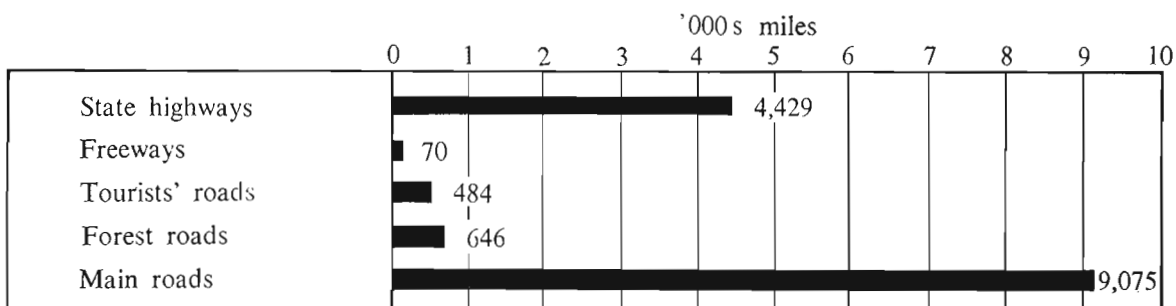

The following table shows the increasing expenditure from the Board's funds on each class of road in financial years 1960/61, 1965/66 and 1970/71:

	1960/61 \$	1965/66 \$	1970/71 \$
State highways	13,761,996	17,703,973	20,464,502
Freeways	2,193,484	3,745,319	18,868,918
Tourists' Roads	1,200,264	1,510,070	2,664,520
Forest Roads	550,730	699,209	902,286
Main Roads	11,838,530	16,568,651	19,373,349
	29,545,004	40,227,222	62,273,575

### State Highways

State highways are the principal road arteries forming interstate connections and links between the larger centres of population in the State. Since the passing of the Highways and Vehicles Act in 1924 the full costs of both construction and maintenance works on State highways for that portion of the carriageway required for through traffic has been charged to the Board's funds.

The total expenditure of \$20,464,502 on Victoria's 32 State highways during the year included an amount of \$9,459 made available from the Roads (Special Projects) Fund. Details of the more significant works completed during the year are listed in Appendix 1.



*Dual carriageways constructed on the Maroondah Highway between Brushy Creek, North Croydon, and Hull Road, Lilydale.*



## Freeways

Freeways are roads generally with dual carriageways and having the distinguishing feature of access being controlled from adjoining properties and from side roads. They provide safe direct routes for heavy volumes of traffic, and allow through traffic to by-pass centres of population. Specially designed interchanges provide connections with other roads and streets.

The Board bears the full cost of all works on freeways. The major freeway project completed during the year was the Lower Yarra Freeway, which will be the main western approach road to the West Gate Bridge. This project is referred to in more detail on page 19 of this report. Other significant freeway works completed during the year are included in Appendix 1.

The mileage of declared freeways in Victoria was extended by 7.0 miles during the year with the formal declaration, under the provisions of the Country Roads Act, of 1.7 miles of the Princes Freeway (Dartmoor Section), 2.0 miles of the Hume Freeway (Beveridge Section), and 3.3 miles of the Tullamarine Freeway.

## Tourists' Roads

Tourists' roads proclaimed under the provisions of the Country Roads Act provide access to places of special interest to tourists both in summer and winter. The Board bears the full cost of works required to cater for the needs of through traffic. In general the works are carried out under the direct supervision of the Board's staff.

Details of the more significant works carried out on tourists' roads during the year are listed in Appendix 2.



*Widened section of the Mount Dandenong Tourists' Road near Sassafra.*

## Forest Roads

Forest roads proclaimed under the provisions of the Country Roads Act are situated within or adjacent to any State forest or in areas which are considered to be timbered, mountainous, or undeveloped. The Board bears the full cost of works required to cater for the needs of through traffic, with approximately half the work carried out on these roads being undertaken by municipal councils on behalf of the Board.

During the year 78 miles of additional forest roads were proclaimed by the Governor-in-Council on the Board's recommendation. The additional roads consisted of the Benambra-Corryong Road in the Shires of Omeo, Towong, and Upper Murray (54 miles) and the Portland-Nelson Road in the Shire of Portland (24 miles). This brings the total number of proclaimed forest roads in Victoria to 30.

Appendix 2 lists the more important works completed during the year.

## Main Roads

Main roads are roads linking centres of population with other centres or with areas of industry, commerce, or settlement. Generally main roads are constructed and maintained by municipal councils to the satisfaction of and with financial assistance from the Board. In some cases at the request of the council works are carried out under the direct supervision of the Board's staff.

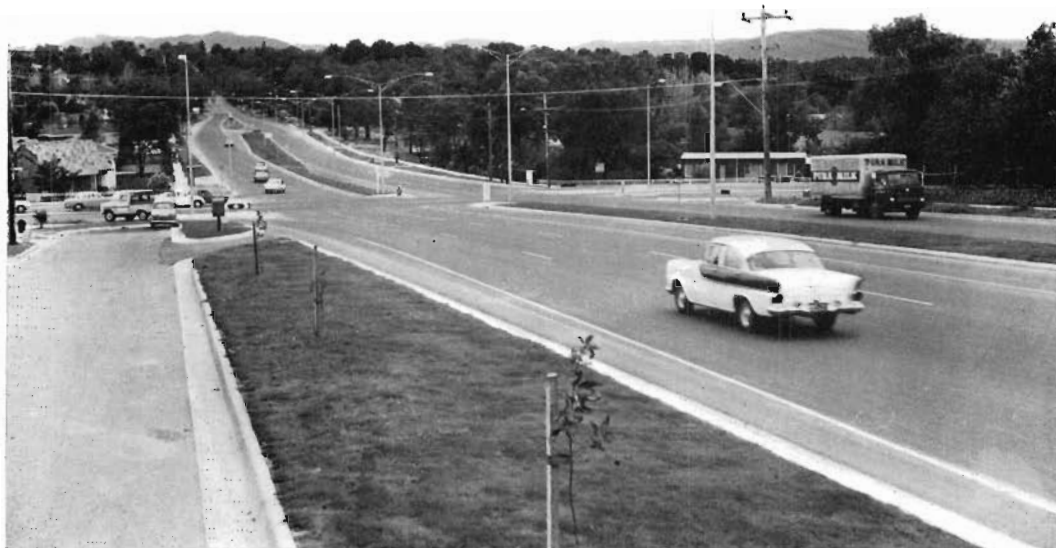

*Reconstruction of the intersection of Canterbury Road and Wantirna Road.*

The following table shows the applications, allocations and expenditure on main roads for the financial years 1969/70 and 1970/71.

Item	1969/70	1970/71
	\$'000s	\$'000s
A Applications	33,305	31,121
B Allocations	23,550	25,481
C Expenditure	17,783	19,373
	%	%
B as percentage of A	70.71	81.88
C as percentage of B	75.71	76.03

A summary of the more important works on main roads completed during the year is given in Appendix 3.

## Unclassified Roads

Roads which are not included in the Board's declared and proclaimed road system are referred to as unclassified roads. These roads are the responsibility of municipal councils but each year the Board provides financial assistance towards the cost of construction and maintenance works, generally in accordance with priorities allotted by municipal councils.

Municipal contributions are determined at the time the allocation is made and are based on many factors including the nature, extent, and location of the particular work and the financial position of the municipality concerned.

The following table shows the total amount of the applications received, allocations made, and expenditure incurred on unclassified roads in the 1969/70 and 1970/71 financial years:

Item	1969/70	1970/71
	\$'000s	\$'000s
Applications (gross)	47,959	55,748
Allocations (Board's funds only)	19,776	24,699
Expenditure (Board's funds only)	16,051	16,967

A list of the more significant works on unclassified roads carried out with financial assistance from the Board during the year appears in Appendix 4.



**LINE-MARKING**

During 1970/71 the Board maintained traffic lines and pavement markings on a total of 6,808 miles of roads. This represented an increase of 8.9% over the previous year as shown in the following table:

	1969/70	1970/71
State highways and freeways	3,890 miles	4,045 miles
Other Declared Roads	1,875 miles	2,073 miles
Unclassified Roads	490 miles	690 miles
<b>TOTAL</b>	<b>6,252 miles</b>	<b>6,808 miles</b>

The work output expressed as miles of "standard stripe" (i.e. a 10 ft. 3 in. line with a 30 ft. gap) was 20,555 miles, an increase of 5.8% over the previous year.

Two large linemarking machines were used for centre-line, lane-line and edge line striping, and two small machines were used for intersection and miscellaneous markings. One new medium sized machine suitable for all types of work was used primarily to enable line marking to be carried out at locations where lines were required ahead of the planned availability of a larger unit. The medium sized machine has proved to be most useful and versatile, and four similar machines are being constructed at the Board's Depot at Sydal. Another large linemarking machine being constructed at Sydal will be ready to be used early in 1971/72. These additional units should ensure that the Board's capacity for line-marking throughout the State will be sufficient to meet future demands.

Costs and quantities of materials used in linemarking during 1969/70 and 1970/71 are shown below:

	1969/70	1970/71
Total expenditure	\$319,437	\$412,776
Roadmarking paint used	53,270 galls.	55,930 galls.
Reflective glass beads used	171.0 tons	185.7 tons
Average cost per mile of standard stripe	\$11.40	\$12.87

Approximately 14,300 raised pavement markers were installed, the majority being on urban freeways where lane lines are indicated by groups of markers each containing one reflective marker followed by four non-reflective discs. The markers provide improved delineation under extreme weather conditions.

**BITUMINOUS SURFACING**

The total length of bituminous surfacing including both sprayed work and plant mix work completed during the year amounted to 3,250 miles at an approximate cost of \$10,860,000. The Board's 20 mobile bituminous surfacing units together with plant owned by municipal councils and contractors completed 3,132 miles of sprayed work at a cost of approximately \$7,672,000.



*Resealing the Grampians Tourists' Road at Halls Gap.*

Contractors operating from fixed asphalt plants completed 118 miles of plant mix work on densely trafficked roads using 254,073 tons of bituminous concrete at a cost of approximately \$3,188,000.

The types of work completed during the year were:

- 245 miles of sealing widened pavements.
- 39 miles of initial sealing on dual carriageways.
- 465 miles of restoration of sealed coats on reconstructed sections.
- 1,660 miles of maintenance retreatments.
- 121 miles sealed on behalf of other State and municipal authorities.
- 720 miles of extensions to the bituminous sealed road system of the State including 107 miles of roads declared or proclaimed under the Country Roads Board Act.

For sprayed work the Board purchased 30,016 tons of bitumen of which 70 per cent was transported by rail. For plant mix work contractors used a further 15,300 tons approximately of bitumen in the production of bituminous concrete used on the Board's works.

A total of 342,878 cubic yards of aggregate was purchased and used for sprayed work and 200,000 cubic yards of aggregate used by contractors in the manufacture of bituminous concrete for the Board's works.

The Board also purchased approximately 14,000 tons of various bituminous materials such as bitumen emulsion, cutback bitumen, bitumen and tar primers and adhesion agents for sprayed work and for the maintenance of sealed roads.

The total length of sealed roads in the Board's declared road network is 13,208 miles or 90 per cent of the total length of declared roads.

## CONTRACTS

### Contracts under the Board's Direct Supervision

Details of the types of contracts entered into and their respective values, together with a comparison with those of financial year 1969/70, are shown in the following table:—

Type of Contract	Number of Contracts		\$ Value	
	1969/70	1970/71	1969/70	1970/71
Road Construction—Major Works (over \$60,000)	22	15	10,440,434	4,647,949
Road Construction—Minor Works (under \$60,000)	23	13	593,563	314,126
Combined Road and Bridge Construction	—	1	—	6,946,427
Supply of Roadmaking Materials	64	68	2,373,012	2,020,310
Bituminous Treatment and Supply of Bitumen	106	92	4,534,411	4,751,643
Bridge Construction	33	37	1,984,551	3,047,594
Manufacture of Bridge Components and Fabricated Steel	18	6	722,499	92,561
Supply of Reinforced Concrete Pipes and Box Culverts	24	19	727,000	1,040,000
Supply of Road and Bridge Construction Equipment	41	53	1,678,655	1,870,733
Divisional Facilities	13	9	137,547	213,472
Miscellaneous Services and Stores	18	31	1,267,318	1,828,596
	362	344	24,458,990	26,773,411

The above figures include contracts being financed from the Roads (Special Projects) Fund, which for the year 1969/70 amounted to 23 having a value of \$7,200,595, and for 1970/71 amounted to 24 having a value of \$2,177,504.

### Contracts under Councils' Supervision

During the year the Board approved the acceptance by municipal councils of 360 tenders for a total amount of \$6,461,343 for road and bridge works for which the Board allocated funds in whole or in part.

The Board also approved the use of 97 municipal contracts for the supply of materials for works partly financed from funds provided by the Board.

## **MATERIALS RESEARCH**

Routine quality control testing of soils and roadmaking materials to ensure their compliance with standard specifications forms the greater part of the work of the Materials Research Division.

In addition, investigations are carried out on structural steels, cement, concrete, and foundation problems, the quality of bitumen and roadmaking paints, the location of new sources of roadmaking materials, the reflective properties of signs and pavement markings, and the strength of road pavements.

These activities require the services of professional officers qualified in the fields of civil and mechanical engineering, chemistry, physics, metallurgy, electronics, geology and geophysics, together with skilled technicians.

During the year a prototype friction welding machine was developed to investigate the practicability of welding stud shear connectors to the flanges of steel bridge girders by using the heat developed by friction between the steels to be welded. During tests satisfactory welds were produced in studs ranging in size from  $\frac{3}{4}$  inch to  $1\frac{1}{4}$  inches in diameter. The welding time for a  $\frac{3}{4}$  inch stud was found to be approximately two seconds. As a result of the success of the prototype welder, a semi-automatic production machine is being designed and built for bridge steel fabrication.

## **NEW SAFER LIGHT POLES TESTED**

During the year officers of the Board conducted tests on a slip-base light pole designed to break away at the base when hit by a vehicle. Such poles reduce the likelihood of critical injury to the occupants of cars hitting them.

A vehicle which hits a light pole with a base which will break away under impact is reduced in speed more gradually than the sudden complete halt which occurs when a vehicle hits a conventional pole.

Experience with slip-base poles in Australia is very limited. In order to obtain more practical information the Board and the State Electricity Commission agreed that some tests should be carried out.

A prototype slip-base pole to overseas design was constructed by the Board and tests were carried out at its Syndal Depot. Following preliminary testing using a pendulum type test a full scale test was carried out in which an "average" car was driven into a slip-base pole at a speed of 32.5 miles per hour under conditions similar to that of a vehicle out of control leaving a road pavement at that speed. The test car had no driver, but with the help of remote control and a mechanical guidance system all other conditions were accurately simulated.

Several facts were observed during and immediately following the impact. The metered speed reading of the vehicle before impact was 32.5 miles per hour. Immediately after impact the speed was 28 miles per hour — a reduction of 4.5 miles per hour.

Members of the Police Accident Appreciation Squad present at the test agreed that damage to the vehicle was mild in comparison with damage observed after collisions with conventional poles.

The behaviour of the slip-base pole itself was accurately recorded by high speed cine cameras for later examination.

Some damage, although not irreparable, was sustained by the pole but the most important feature was the fact that it fell and remained in a position on the ground well clear of the roadway. The electrical connections designed in consultation with the State Electricity Commission were also successful in guarding against the possibility of the base of the pole remaining electrically alive after the collision.

The Board has installed slip-base lighting poles at certain locations on the Lower Yarra Freeway.

## **LOWER YARRA FREEWAY**

The Lower Yarra Freeway, which will serve as the western approach to the West Gate Bridge project, was opened to traffic on 7th April, 1971, between its connection with the Princes Highway near Kororoit Creek and Williamstown Road. Connections between the four mile freeway and the existing street system have been provided at the Princes Highway, Grieve Parade, Millers Road and Williamstown Road. At these locations interchanges allow traffic using the local street system to pass over or under the freeway.

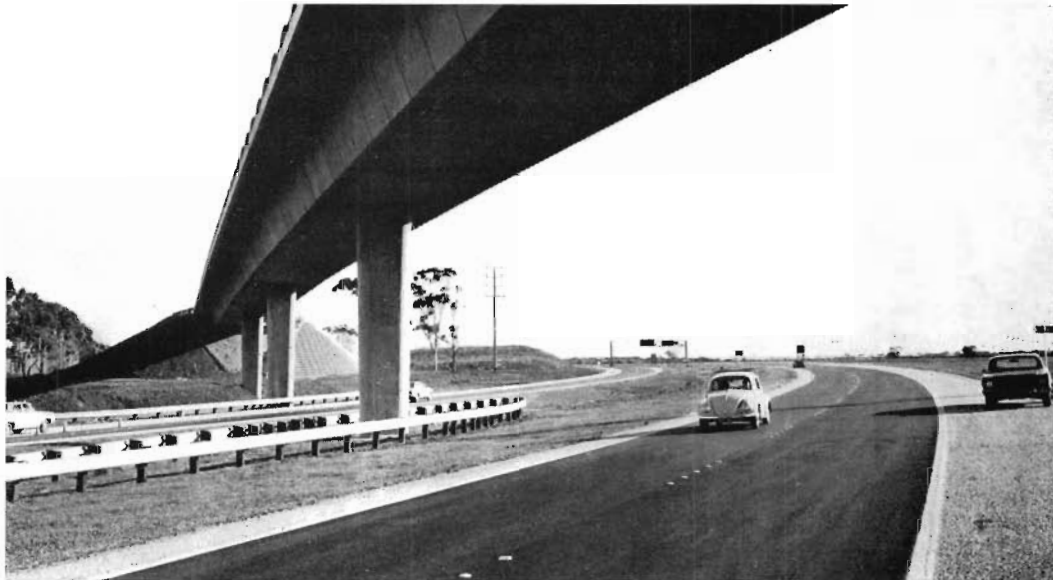

*The Lower Yarra Freeway at the Princes Highway intersection.*

There are no at-grade intersections or traffic signals on the through carriageways. Four traffic lanes have been provided between the Princes Highway and Millers Road and six traffic lanes between Millers Road and Williamstown Road. The traffic lanes can be increased to eight in the future by reducing the width of the median.

The project involved the construction of fourteen bridges, including pedestrian overpasses at Rosala Avenue—Altona North; and Wembley Avenue—Spotswood.

The generally shallow depth of basalt rock in this area precluded the use of depressed gradelines, so the freeway is elevated in fill for much of its length. The material used was the natural basaltic clay prevalent in the area. The pavement consists of 4 inches of bituminous concrete over 15 inches of crushed rock base and 15 inches of sub-base. Shoulders were constructed in crushed rock only and flush sealed with light coloured aggregate.

Relocation of services was carried out by the authorities responsible for water mains, sewers, trunk telephone cables, high pressure gas mains, overhead power lines, and underground power cables. The total cost of relocating services was \$2M, of which the major item was the replacement of the electricity transmission lines running the entire length of the freeway.

Construction of the freeway involved three major roadworks contracts to a total value of \$3.6M, eight bridge contracts to a total value of \$1.1M and numerous smaller contracts for landscaping, tower lighting, traffic signals, and other ancillary features.

Local access roads formerly across the freeway alignment were severed by construction of the freeway, and new access roads, namely Fogarty Avenue adjacent to the Newport-Sunshine railway and Grieve Parade have been constructed as a charge against the main project.

The total expenditure by the Board on the Lower Yarra Freeway was \$13.9M, which includes \$2.8M for half the cost of the Williamstown Road interchange which was built by the Lower Yarra Crossing Authority.

## **SPECIAL PROJECTS**

Following the enactment of the Roads (Special Projects) Act 1965 a special fund was established into which is paid a specified proportion of each motor registration fee and each trailer registration fee. This fund, called the Roads (Special Projects) Fund, is administered by the State Treasurer for the purpose of providing finance for special road projects throughout the State. Approximately one-third of the moneys paid into the fund are allotted to the Board for roadworks in rural type areas, the balance being spent by the Melbourne and Metropolitan Board of Works.

The Roads (Special Projects) Fund has enabled the State's road construction programme to be accelerated beyond that which would have been possible from the normal funds available to the Board.

Works to be financed from the Roads (Special Projects) Fund must be approved by the Governor-in-Council on the recommendation of the Treasurer of Victoria. Each financial year the Board submits recommendations through the Minister for Local Government to the Treasurer for Special Projects to be carried out or commenced during the year. The Board's recommendations have aimed at extending the length of dual carriageways on the heavily trafficked State highways radiating from Melbourne in addition to the Board's own major works programme, and the extension of the mileage of roads of tourist interest throughout the State.

Special Projects on which work was carried out during the year are detailed below:

Project No.	Project	Length (Miles)	Progress of Work
5.	<b>Western Highway</b> —Extension of the four lane divided highway from Deer Park to west of Bacchus Marsh (including the Bacchus Marsh section of the Western Freeway).	22.3	12.5 miles of divided highway already constructed. Construction of the Bacchus Marsh section of the Western Freeway is well advanced.
8.	<b>Hume Highway</b> —Extension of the four lane divided highway from south to north of Tallarook, including a bypass of Tallarook.	4.5	Work completed.
16.	<b>Western Highway</b> —Construction of a four lane divided highway from east of Ballarat, including the bypass of the townships of Gordon, Wallace and Bungaree.	11.0	Construction of the Gordon section of the Western Freeway (5 miles) is well advanced.
17.	<b>Hume Highway</b> —Construction of a four lane divided highway from south of Wallan to North of Broadford.	19.5	Detailed investigation, survey, design, and land acquisition are proceeding.
19.	<b>Mt. Abrupt Road</b> —Construction of a road for tourists from north of Dunkeld to join the Grampians Road south of Mirranatwa Gap.	16.0	Work completed.



*Special Project No. 19—The Mt. Abrupt Road north of Dunkeld.*

27.	<b>Mulgrave Freeway</b> —Construction of a four lane freeway from west of Stud Road to and including the interchange with Eumemmerring Freeway.	2.7	Construction of 3.7 miles is continuing.
28.	<b>Eumemmerring Freeway</b> —Construction of a four lane freeway from the interchange with the Mulgrave Freeway to south of the Princes Highway East interchange.	1.0	

Project No.	Project	Length (Miles)	Progress of Work
29.	<b>Mornington Peninsula Freeway</b> —Construction of a four lane freeway for a length of 5 miles from the Nepean Highway near Palmerston Avenue, Dromana, to Eastbourne Road.	5.0	Construction is continuing.
			
<p><i>Special Project No. 29—The Mornington Peninsula Freeway. Construction of twin bridges to carry the freeway over McCulloch Street at Dromana.</i></p>			
30.	<b>Western Freeway</b> —Pentlands Hills section, including a bypass of Myrniong.	7.0	Detailed investigation and land acquisition are proceeding.
31.	<b>Calder Highway</b> —Realignment of the highway at Porcupine Hill.	1.3	Preliminary earthworks commenced.

Expenditure from the Roads (Special Projects) Fund by the Board on behalf of the State Government during the year was \$7,760,785. Since the inception of the scheme in 1965/66 the Board has expended a total of \$21,965,175 on Special Projects.

## BRIDGES

### CONSTRUCTION OF NEW BRIDGES

During the year the construction of 166 new bridges estimated to cost \$8,333,000 commenced either under the direct supervision of the Board, or under municipal supervision with financial contributions from the Board. The table below gives a comparison between the number and estimated cost of bridge projects commenced in 1970/71 and those for the preceding financial year.

Description	1969/70		1970/71	
	Number	Estimated cost	Number	Estimated cost
Bridges commenced under the Board's supervision	83	\$6,451,000	69	\$6,823,000
Bridges commenced under municipal supervision with financial assistance from the Board	80	\$1,629,000	97	\$1,510,000
Total bridges commenced	163	\$8,080,000	166	\$8,333,000

In addition, 3 sign gantries costing \$51,000 were manufactured and erected to support large overhead direction signs on freeways.

### LARGE BRIDGES COMPLETED IN RURAL AREAS

Some of the larger bridges constructed in rural areas of Victoria during the year under the supervision of the Board's staff included:

- (a) **Road over Rail Overpass—Western Highway, City of Ballarat:** A four-span welded plate girder and reinforced concrete overpass structure 251 feet long by 74 feet wide including two roadways each 30 feet wide separated by a median 14 feet wide on a new alignment of the Western Highway east of the present Caledonian Bridge at Ballarat.



*New Western Highway bridge under construction over the railway at Ballarat.*

- (b) **Road over Rail Overpass at Lyons—Princes Highway West, Shire of Portland:** A 22 feet diameter corrugated steel multiplate pipe tunnel 330 feet long carrying the Mt. Gambier railway line under the highway at the 249 milepost near Lyons, east of Dartmoor.



- (c) **Western Freeway—Bacchus Marsh Section:** Eight large prestressed and reinforced concrete bridges ranging in size up to 310 feet long by 34 feet wide, and of a total cost of approximately \$1,350,000. The bridges include interchange structures, structures over the Lerderderg River, together with various access structures.



*Construction of the western interchange bridge on the Western Freeway (Bacchus Marsh section).*

- (d) **Western Freeway—Gordon Section, Shire of Ballan:** Two post-tensioned and reinforced concrete two-span continuous box girder structures 250 feet and 272 feet long by 28 feet between kerbs.

Included amongst the larger bridges completed during the year under municipal supervision with financial assistance from the Board were:

- (a) **Kirks Bridge over Little River—Kirks Bridge Road, Shire of Corio:** A three-span composite steel girder and reinforced concrete bridge 153 feet long and 24 feet between kerbs replacing an old timber bridge.
- (b) **Broken River—Archer Street, Shire of Shepparton:** A five-span prestressed concrete beam and reinforced concrete bridge 202 feet long and 28 feet between kerbs.
- (c) **Smith's Bridge over Toolern Creek—Griegs Road, Shire of Melton:** A three-span prestressed concrete beam and reinforced concrete bridge 126 feet long and 24 feet between kerbs.
- (d) **Plenty River—Para Road, Shire of Diamond Valley:** A four-span precast high strength U slab reinforced concrete bridge 130 feet long by 28 feet between kerbs.
- (e) **Clarke's Bridge over Deep Creek—Castlemaine-Ballarat Road, Shires of Creswick and Newstead:** A three-span high strength U slab and reinforced concrete bridge 106 feet long by 24 feet between kerbs. The Board's Chairman, Mr. I. J. O'Donnell, took part in the opening and naming ceremony held at the bridge on 12th March, 1971.

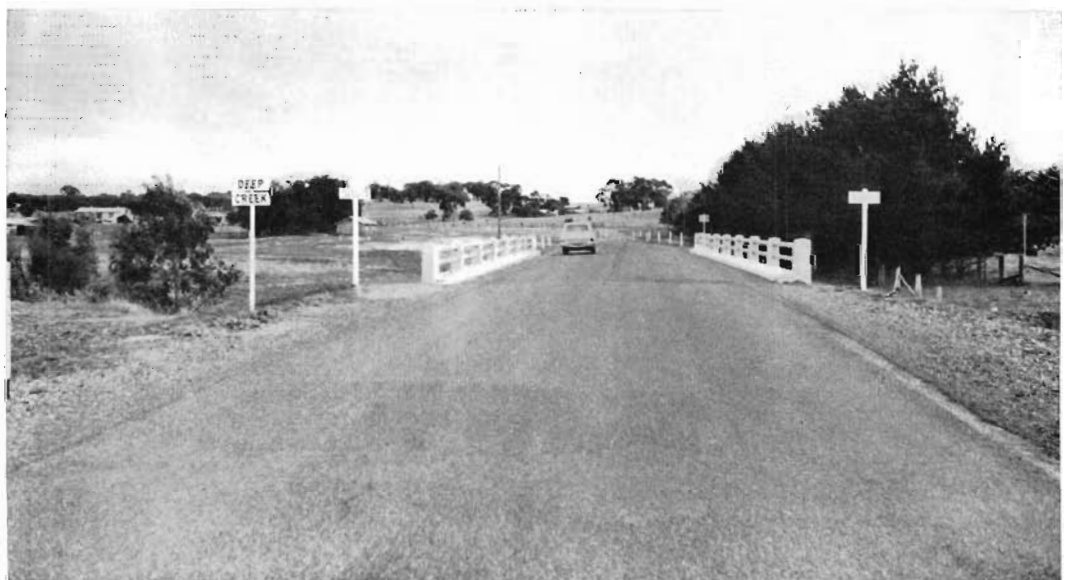

*Clarke's bridge over Deep Creek on the Castlemaine-Ballarat Road, Creswick and Newstead Shires.*



- (f) **Scott's Creek—Cobden-Port Campbell Road, Shire of Heytesbury:** A three-span prestressed concrete beam and reinforced concrete bridge 134 feet long by 28 feet between kerbs.

## METROPOLITAN BRIDGES AND OVERPASSES

Amongst the larger bridges in the metropolitan area on which construction proceeded or was completed under the direct supervision of the Board's staff, were:

- (a) **Graham Street—Railway Overpass, City of Port Melbourne:** A thirteen-span composite steel girder and reinforced concrete structure, 690 feet long and with two carriage-ways each 26 feet between kerbs, carrying traffic over the railway line near Graham Station was completed. An existing pedestrian subway with approach ramps was also reconstructed by the Victorian Railways as a part of this project.
- (b) **Lower Yarra Freeway—Overpass at Princes Highway West:** A five-span continuous post-tensioned segmental concrete box girder bridge 560 feet long and 28 feet between kerbs at the interchange of the Lower Yarra Freeway with the Princes Highway West, was completed.
- (c) **Lower Yarra Freeway—Underpass at Doherty's Road:** A five-span prestressed concrete beam and reinforced concrete bridge 423 feet long by 28 feet wide plus a footway 6 feet wide, taking Doherty's Road over the freeway, was completed.
- (d) **Mulgrave Freeway (Stud Road to Princes Highway East):** Construction proceeded on the ten large bridges and overpass structures at a total cost of \$2,000,000 included in the above project. Completion is expected early in 1972.
- (e) **Princes Highway West—Rail Overpass at West Footscray:** Work was commenced on the \$2,000,000 project to replace the existing rail overpass and considerably improve traffic facilities in this area. The new structure will be 305 feet long by 77 feet wide, providing six lanes for traffic. A pedestrian overpass and several other structures on the approaches to the rail overpass will cater for cross traffic.

## GRADE SEPARATED PEDESTRIAN OVERPASSES

### 1. Restoration of Access across Freeways

Frankston Freeway—Skye Road—The Board completed the construction of a four-span prestressed concrete beam and reinforced concrete overpass 475 feet long by 6 feet wide with curved approach ramps to restore pedestrian access over the Frankston Freeway in the vicinity of Skye Road.

### 2. Assistance to Municipal Councils

City of Caulfield—At the request of the Council the Board is supervising the construction of a pedestrian overpass 58 feet long by 6 feet wide over Grange Road in the vicinity of Glenhuntly Primary School.

### 3. State Government's Scheme for grade separated crossings to serve schools

In addition to the seven grade separated crossings completed to 30th June, 1970, the Government has approved the construction of eighteen other crossings to serve schools.



*Pedestrian overpass over Heidelberg Road at Silk Street, Rosanna.*

The approximate location and progress of work on the approved projects is shown below:

<b>Municipality</b>	<b>Road</b>	<b>Approximate Location</b>	<b>Progress to 30th June, 1971</b>
Essendon City	Buckley Street	Leslie Road near St. Columba's Girls' College Lowther Hall Girls' College and Penleigh Girls' School	Preliminary investigation completed
Collingwood City	Johnston Street	Clarke Street near St. Euphrasia Roman Catholic School	Structural design commenced
Heidelberg City	Heidelberg Road	Silk Street, Rosanna, near Rosanna Golf Links Primary School and Roman Catholic School	Completed January, 1971
Box Hill City	Burwood Highway	Bennettswood Primary School	Preliminary investigation completed
Box Hill City	Canterbury Road	St. Leo's College	Structural design commenced
Frankston City	Frankston-Flinders Road	Davey Street near Frankston Primary School, and Roman Catholic School	Plans of two alternative proposals being considered in conjunction with the Frankston City Council
Melbourne City	Boundary Road	North Melbourne Primary School	Structural design commenced
Coburg City	Sydney Road	Catholic Girls' Regional School	Preliminary investigation commenced
Box Hill City	Belmore Road	Koonung Heights Primary School	No detailed planning carried out
Doncaster and Templestowe City	Manningham Road	Bulleen Primary School and St. Clements	No detailed planning carried out
Moorabbin City	South Road	Tucker Road Primary School, Moorabbin Technical School and St. Catherine's	Preliminary investigation commenced
Oakleigh City	Warrigal Road	Oakleigh Primary School	Preliminary investigation commenced
Oakleigh City	Princes Highway East	Oakleigh High School	Preliminary investigation commenced
Heidelberg City	Heidelberg-Eltham Road	Ivanhoe Boys' Grammar School Christian Brothers' Prep. School	Preliminary investigation commenced
Sunshine City	Western Highway	Deer Park Primary School	Structural design commenced
Nunawading City	Mitcham Road	Mitcham High School Mitcham Primary School	Preliminary design being considered in conjunction with Nunawading City Council
Doncaster and Templestowe City	Manningham Road	Templestowe High School	Alternative proposals being considered in conjunction with the Doncaster and Templestowe City Council
Doncaster and Templestowe City	Doncaster Road	Doncaster Primary School	Construction drawings commenced

## BRIDGE AND CULVERT MATERIALS

Reinforced concrete pipes purchased directly by the Board during the year were valued at \$328,000. A total of 29,500 lineal feet of reinforced concrete box culverts valued at \$254,000 was also purchased for works carried out directly by the Board.

In addition, reinforced concrete pipes and box culverts valued at \$42,000 were purchased by the Board's contractors for use on the Board's works.

Corrugated steel pipes and culverts used were valued at \$90,500 and 132,400 lineal feet of corrugated steel guardrail valued at \$132,000, was purchased.

There was a 20% increase over the previous year in the use of fabricated reinforcing steel with approximately 4,800 tons valued at \$750,000 being supplied to bridge projects. Welded steel girders used in bridges weighed approximately 1,110 tons.

Approximately 12,000 tons of various precast concrete bridge units valued at \$470,000 were produced in the Board's precasting yards throughout the State, and prestressed concrete bridge units totalling \$73,000 in value were purchased from Melbourne suppliers. Units were also purchased direct by the Board's bridge contractors from approved suppliers following checking by the Board's staff and 1,100 tons of these units, valued at \$82,000, were supplied in this manner.

## ELIMINATION OF RAILWAY LEVEL CROSSINGS

Since the inception of the State Government scheme in 1954 to improve or replace railway level crossings with grade separated crossings, 54 level crossings throughout Victoria have been replaced by overpasses or underpasses constructed by the Board or the Victorian Railways. These works represent a total expenditure of approximately \$25 million.

Details of the history of the Government's scheme and the method of financing such projects are discussed on pages 29 and 30 of the Board's 1969/70 Annual Report.

The construction of the following grade separated overpasses was completed during the year:

### Princes Highway East—Traralgon

A two-lane road bridge 50 feet wide has been constructed over the Traralgon-Maffra railway line. Provision has been made for future duplication of the bridge. The Victorian Railways was the constructing authority.

Week-day traffic between the hours of 7 a.m. and 7 p.m. is approximately 2,680 vehicles on this section of the highway and 12 to 16 trains pass under the road bridge each day. The cost of the project was \$314,000.



*Road over rail bridge replacing the level crossing on the Princes Highway at Traralgon.*

### **Calder Highway—Elphinstone**

A road over rail overpass has been constructed on a deviation of the Calder Highway. The level crossing in Elphinstone will remain open and flashing lights installed. The Board was the constructing authority.

Traffic using the highway between 7 a.m. and 7 p.m. daily is approximately 1,000 vehicles. Rail traffic is normally 25 trains per day with seasonal increases. The total cost of the project was \$240,000 of which 95% was financed as a level crossing elimination project.

The following projects were continued or commenced during the year:

### **Elgar Road—Box Hill**

Work continued on the construction of a rail over road overpass on the Box Hill railway at Elgar Road. The Victorian Railways is the bridge constructing authority, the Board being responsible for lowering the level of Elgar Road under the bridge. Between the hours of 7 a.m. and 7 p.m. the average week day traffic on Elgar Road at this crossing is approximately 9,000 vehicles, and the number of trains using the crossing during the same period is approximately 162. The total estimated cost of the project is \$1,200,000.

### **Horsham**

Work continued on the construction of a road over rail overpass between Kalkee Road and Urquhart Street, Horsham, to eliminate two level crossings of the Melbourne-Adelaide railway at McPherson Street and Wawunna Street. The Board is the constructing authority.

It is estimated that the new overpass will cater for more than 5,000 vehicles per day, eliminating delays caused by up to 32 trains daily at certain times of the year. The total estimated cost of the project is \$700,000.

### **North Road—Huntingdale**

Work commenced on the construction of a road over rail overpass to replace the level crossing of the Dandenong railway at North Road, Huntingdale. The Victorian Railways is the bridge constructing authority, and the Board and the Oakleigh City Council are responsible for the construction of the approaches and associated roadworks.

In excess of 15,000 vehicles use the crossing daily between 7 a.m. and 7 p.m. Approximately 175 trains pass through the crossing on a full week-day. The estimated total cost of the project is \$1,813,000.

### **Millers Road—Paisley**

Preliminary work commenced on the construction of a road over rail overpass of the Melbourne-Warrnambool railway at Paisley. The Board is the constructing authority.

More than 10,000 vehicles use this section of Millers Road between 7 a.m. and 7 p.m. daily, and approximately 56 trains use the level crossing in a full day. The total estimated cost of the project is \$1,042,000.

Expenditure during financial year 1970/71 on projects undertaken as a result of recommendations made by the Abolition of Level Crossings Committee was borne in the following proportions:

Level Crossings Fund	45%
Country Roads Board	50%
Victorian Railways	5%

During the period from 1967/68 to 1969/70 inclusive expenditure on abolition projects was generally apportioned 35% Level Crossings Fund, 45% Country Roads Board and 20% Victorian Railways.

## **NATIONAL PARKS SERVICE**

Once again the State Government increased the Board's loan allocation to provide \$97,000 for expenditure on roads and associated purposes in or near National Parks. Allocations were made by the Board after consultation with the National Parks Service (formerly the National Parks Authority) for works in or near:

- The Bulga National Park in Alberton Shire
- The Ferntree Gully National Park in Sherbrooke Shire
- The Fraser National Park in Alexandra Shire
- The Glenaladale National Park in Bairnsdale Shire
- The Hattah Lakes National Park in Mildura Shire
- The Lind National Park in Orboſt Shire
- The Mount Buffalo National Park in Bright Shire
- The Mount Richmond National Park in Portland Shire
- The Port Campbell National Park in Heytesbury Shire
- The Wilsons Promontory National Park in South Gippsland Shire
- The Wyperfeld National Park in Karkaroc Shire

The work consisted of construction and sealing of access roads and roads within National Parks, parking areas and the maintenance of roads already constructed. The works were carried out either by the Board or the municipal council concerned.

The Government has made loan funds totalling \$797,000 available for these purposes since 1st July, 1963.

## **MINISTRY OF TOURISM**

Since 1st July, 1960, the State Government has provided the Board with loan funds to a total amount of \$2,194,000 for expenditure after consultation with the Tourist Development Authority, later the Ministry of Tourism, on roads of a tourist nature other than roads proclaimed as tourists' roads under the provisions of the Country Roads Act.

The allocations made from the amount of \$194,000 made available in financial year 1970/71 included amounts for work to be carried out on Truemans Road in Flinders Shire, the Nelson Beach Access Road in Portland Shire, the western approach to Mount Baw Baw, the North Redesdale Road in Metcalfe Shire and the completion of an access road to Mount Rouse in Mount Rouse Shire.

The applications for these funds received from municipal councils far exceed the amount of funds available. The total expenditure of \$2,144,000 to 30th June, 1971, has made significant progress in the provision of adequate access to many of Victoria's tourist attractions.

The Board is required to make an annual payment into the Tourist Fund amounting to two per cent of the amount credited to the Country Roads Board Fund in the previous year from receipts under the Motor Car Act. An amount of \$617,363 was paid during the year. The Tourist Fund is administered by the Ministry of Tourism.

## **MUNICIPALITIES FOREST ROADS IMPROVEMENT FUND**

In 1951, the Board and the Forests Commission conducted a State-wide survey to assess the needs of access roads to forest areas. In 1955 the State Treasury established the Municipalities Forest Roads Improvement Fund to be used to assist municipalities in the improvement and protection of roads adjacent to State forest areas, to facilitate the extraction of forest produce.

Applications for grants from the Fund have always exceeded the moneys available, and grants are made in order of urgency of the works submitted. Priorities are allotted, on a State-wide basis, following investigation by the Board's Divisional Engineers. The priorities are discussed with the Forests Commission and agreement reached on works for which allocations are made.

The contributions to the Fund by the Government to 30th June, 1971, total \$430,000.

Expenditure from the Fund during the financial year was \$37,958, increasing the total expenditure to \$417,958.

## CONTROL OF HEAVY TRAFFIC

In the interests of safety of the road users and the protection of the road itself, it is necessary for the Government to impose statutory limits on the weight, width, height and length of vehicles and their loads.

The Board is responsible for controlling the movement of vehicles and loads which exceed the limits imposed by the Motor Car Act, and for ensuring as far as possible that vehicles in excess of the statutory limits do not travel on roads unless a permit has been issued for a specific route selected as suitable for such travel.

The following table sets out the number and type of permits issued during the year compared with those issued during financial year 1969/70.

	1969/70	1970/71
Single trip permits issued at Head Office	18,725	20,216
Single trip permits issued at Divisional Offices	6,949	7,225
Annual permits issued at Head Office	3,076	3,178
90-Day permits issued	459	470
Container permits issued	62	75
<b>Total number of permits issued</b>	<b>29,271</b>	<b>31,164</b>
Included in these totals were permits for:		
70 tons gross and over	503	654
100 tons gross and over	58	58

Strategically placed weighbridges adjacent to the carriageways of State highways which carry high volumes of commercial vehicles are an essential part of the Board's activities. As commercial vehicles have increased in size over the years the capacity of many of the Board's older weighbridges has had to be increased.

Weighbridges have been installed by the Board at the following locations:

Highway	Location	Size	Capacity	Installed
Hume	Wallan	8' x 10'	20 Ton	1955
Hume	Kilmore	8' x 10'	20 "	1961
Hume	Seymour — 1	16' x 12'6"	50 "	1966
Hume	Seymour — 2	16' x 10'	40 "	1953
Hume	Benalla	16' x 10'	40 "	1954
Calder	Carlsruhe	8' x 10'	20 "	1958
Western	Melton	16' x 10'	20 "	1966
Princes East	Yarragon	16' x 10'	20 "	1967
Princes East	Bairnsdale	8' x 10'	20 "	1966
	Syndal Depot	16' x 10'	20 "	1966
In process of installation —				
Maroondah	Yarck	16' x 10'	40 Ton	
Sturt	Mildura — 12 miles west	16' x 10'	40 "	

Traffic Officers appointed by the Board patrol the State's principal road system and have power to prosecute for offences relating to weight, height, length, width and speed where such offences occur on State highways, main roads, tourists' roads, forest roads and freeways declared or proclaimed under the provisions of the Country Roads Act, or on a journey which includes travelling over unclassified roads in two or more greater metropolitan municipalities as defined in the Motor Car Act.

A total of 9,079 offences were reported during the year, which resulted in \$390,436 in fines and costs payable into Consolidated Revenue.

## LEGISLATION AFFECTING THE BOARD

Legislation enacted during the year which affected the Board included the following:—

### **Country Roads (Amendment) Act 1971 No. 8140**

This Act made provision for:

- (a) the Board to appoint any person to be an officer or employee of the Board provided that no officer or employee shall, without the approval of the Minister, be appointed by the Board at a salary exceeding the rate of \$8,500 per annum;
- (b) the formation of a Street Lighting Committee and for the Board to expend its funds on the installation, maintenance and operation of street lighting on State highways;
- (c) the removal of the necessity for the Board to obtain the recommendation of the Minister of Public Works before submitting a recommendation to the Governor-in-Council for the proclamation of a forest road.
- (d) the substitution of a new Section for Section 117 of the Country Roads Act to enable the Board to carry out work for and on behalf of and at the expense of —
  - (i) the Commonwealth of Australia
  - (ii) the State of Victoria
  - (iii) a municipality or other public authority
  - (iv) a person owning land adjoining any works of the Board where the work on that land arises out of or is connected with the works of the Board.

Where the total estimated cost exceeds \$20,000, the Board shall, before commencing such work, obtain the approval of the Governor-in-Council.

- (e) the Board to hire its plant, at rates determined by the Board to:
  - (i) the Commonwealth of Australia
  - (ii) the State of Victoria
  - (iii) a municipal council or other public authority
  - (iv) contractors carrying out work for the Commonwealth of Australia, the State of Victoria, a municipal council or other public authority
  - (v) any person where the plant is of a type which cannot otherwise be hired and the work to be carried out is in the public interest.
- (f) the Board, with the agreement of the person entitled to compensation and in full or part settlement of land compensation, to
  - (i) transfer a building from land owned by the person entitled to the compensation or other land owned either by that person or by the Board; or
  - (ii) transfer a building from land owned by the Board to other land owned either by the Board or by a person entitled to the compensation;
- (g) a statement by any officer of the Board in any legal proceedings that any road is a State highway, main road, tourists' road, forest road, developmental road or freeway to be sufficient evidence of such fact until the contrary is shown.

### **Motor Car (Fees) Act 1970 No. 8048**

This Act provided, amongst other things, for:

1. a change in the additional fee payable on initial registration or transfer of a vehicle from 25 cents per horse power to a fixed fee of \$7 per vehicle. Two-thirds of such "additional registration fees", less cost of collection, are paid into the Country Roads Board Fund. This change came into operation on 1st July, 1971,
2. an increase in fees for motor car drivers' licences from \$6 to \$12, for motor tractor drivers' licences from \$2 to \$4 and for driving instructors' licences from \$20 to \$40. These increases operated from 1st January, 1971,
3. the creation of a Drivers' Licence Suspense Account in the Treasury,
4. the payment into the Drivers' Licence Suspense Account of one-eighth of the fees less cost of collection charged for drivers' licences,

5. the payment out of the Drivers' Licence Suspense Account of such amounts as the Treasurer determines into the Traffic Commission Fund and to the Melbourne and Metropolitan Tramways Board,
6. a consequential amendment to Section 38 of the Country Roads Act 1958, relating to moneys paid into the Country Roads Board Fund.

Following the coming into operation of the various sections of this Act, the fees received for licences are apportioned as follows:

Motor car drivers' licence fees and motor tractor drivers' licence fees:

Country Roads Board Fund	1/8th
Drivers' Licence Suspense Account	1/8th
Municipalities Assistance Fund	2/8ths
Consolidated Fund	4/8ths

Motor driving instructors' licence fees:

Country Roads Board Fund	1/4th
Municipalities Assistance Fund	1/4th
Consolidated Fund	2/4ths

### **Statutory Salaries Act 1970 No. 8082**

Amongst other things, this Act amended Section 6 of the Country Roads Act 1958, to make provision for the salaries of the Members of the Board to be amended at any time by the Governor-in-Council instead of only at, or prior to, the appointment of Members of the Board.

## **MUNICIPAL INSPECTIONS**

From the inception of the Board it has been the practice for the Members of the Board to visit municipalities in turn in order to maintain up-to-date personal knowledge of road conditions throughout the State.

The aim is to visit each municipality at not more than six-yearly intervals and inspect, in company with municipal councillors and municipal officers, roads and bridges which are under the care and management of the council. The information obtained is of great value to the Board in allocating funds for works on these roads, and ensuring that there is a balanced development of roads in the State.

During the year the Board visited thirty-five municipalities, namely, Shires of Alberton, Ballan, Barrabool, Beechworth, Birchip, Chiltern, Croydon, Donald, Gisborne, Karkaroc, Leigh, Lillydale, Morwell, Mount Rouse, Phillip Island, Portland, Pyalong, Rutherglen, South Barwon, Traralgon, Upper Murray, Waranga, Warracknabeal, Wodonga and Yarrawonga, the Borough of Wonthaggi, the Town of Portland and the Cities of Broadmeadows, Essendon, Knox, Ringwood, Sale, Sunshine, Traralgon and Waverley.

The Board was pleased to note the continued progress being made in improving the municipal road systems and the development occurring in many parts of the State. The arrangements made by the councils to facilitate the inspections are very much appreciated by the Board.

## **DEPUTATIONS**

The Board is always prepared to discuss matters of mutual interest with representatives of municipal councils.

Twenty-one deputations were received during the year, the principal topics being the level of grants for road and bridgeworks, requests for additional road declarations, and traffic problems in urban areas. Conservation and the effects of road construction on the environment were also raised.

The solutions to many of the problems raised hinge upon sufficient funds being available, but even where no immediate solution can be offered, the exchange of information is of value to the Board in future planning.



## TWENTY-SEVENTH CONFERENCE OF MUNICIPAL ENGINEERS

The Twenty-seventh Annual Conference of Municipal Engineers convened by the Board was held under the chairmanship of Mr. I. J. O'Donnell, on 9th and 11th February, 1971, concluding with an inspection of Melbourne Airport (Tullamarine) on 12th February.

Approximately 240 engineers attended representing most Victorian municipalities and several government departments and instrumentalities. The Board was pleased to welcome visiting local government engineers from Tasmania and Western Australia to the conference.



*The 27th Conference of Municipal Engineers held at the Board's Head Office in February, 1971.*

Mr. R. D. L. Fraser, Chairman of the Town and Country Planning Board, addressed the conference on planning matters and papers were presented on the Design of Flood Retarding Basins, Shire Mapping and Surveys, and the State Disaster Plan. Reports on overseas study tours were also presented.

Technical subjects covered by the Board's engineers included materials testing and pavement construction, design of divided roads, blasting procedures, developments in line-marking and road furniture, and the landscaping of medians. Skid resistance of road surfaces and speed limit zoning in rural townships were also discussed.

The success of this annual conference depends upon the standard and variety of the papers presented. The Board extends its thanks to the many contributors to the Twenty-seventh Conference and to the Commonwealth Department of Works for the ready co-operation in arranging the visit to Tullamarine.

## MUNICIPAL ASSOCIATION CONFERENCES

The Board was pleased to be represented at the following municipal conferences during the year:

<b>Conference</b>	<b>C.R.B. Representation</b>
1. Municipal Association of Victoria — 78th Annual Session, 14th October, 1970, South Melbourne.	Mr. I. J. O'Donnell, Chairman, attended the opening session.
2. Gippsland Municipalities Association — Annual Conference, 30th April, 1971, Omeo.	Mr. W. H. Dolomore, Divisional Engineer—Bairnsdale.
3. Goulburn North-East Municipalities Association — Annual Conference, 25th March, 1971, Tallangatta.	Mr. R. R. Patterson, Divisional Engineer—Benalla.
4. Northern District Municipal Association — Annual Conference, 22nd April, 1971, Kyneton.	Mr. T. M. Glazebrook, Divisional Engineer—Bendigo.
5. North-Western Municipalities Association — Annual Conference, 11th June, 1971, Kaniva.	Mr. J. W. Heid, Divisional Engineer—Horsham.
6. Western District Municipalities Association — half-yearly meeting, 2nd October, 1970, Casterton.	Mr. F. G. Lodge, Divisional Engineer—Warrnambool, Mr. I. J. O'Donnell, Chairman, and Mr. R. E. V. Donaldson, Deputy Chairman, attended the opening session.
Annual Meeting held 31st March, 1971, Hamilton.	Mr. J. D. Thorpe, Board Member, and Mr. F. G. Lodge, Divisional Engineer—Warrnambool.

The Board has always valued the co-operation it receives from municipal councils in providing, maintaining and improving the State's road system and is grateful for the opportunity of attending these conferences.

## NATIONAL ASSOCIATION OF AUSTRALIAN STATE ROAD AUTHORITIES

The National Association of Australian State Road Authorities was formed to ensure the co-ordinated uniform development of roads throughout Australia. The Association consists of the Commissioners of each of the State road authorities and the Director General of Works, Commonwealth Department of Works, meeting at six monthly intervals.

Eleven Standing Committees composed of appropriate representatives of these authorities meet annually. The Committees are titled Principal Technical, Secretarial and Accounts, Advance Planning, Bituminous Pavements, Bridge Engineering, Construction and Maintenance Practice, Computer, Geometric Road Design, Materials Research, Plant and Equipment, and Traffic Engineering.

The main annual meeting of the Association is held in turn in each Capital City, and Melbourne was the venue in 1970. This 43rd Meeting of NAASRA was held at the Board's Head Office on 2nd, 4th, and 6th November, 1970, under the chairmanship of Mr. I. J. O'Donnell. The Board's Deputy Chairman, Mr. R. E. V. Donaldson, and Member, Mr. J. D. Thorpe, attended together with Mr. D. H. Aitken, Commissioner of Main Roads, Western Australia; Mr. A. K. Johnke, Commissioner of Highways, South Australia; Mr. H. A. Lowe, Commissioner of Main Roads, Queensland; Mr. A. S. Reiher, Director General, Commonwealth Department of Works; Mr. R. C. Sharp, Director, Department of Public Works, Tasmania; Mr. R. J. S. Thomas, Commissioner for Main Roads, New South Wales. The main items on the agenda were SAA standards, technical publications, research projects to be undertaken by the ARRB and NAASRA, PMG services, pipelines on road reserves, road design and signing, and training of engineers from overseas. Representatives of the Department of Shipping and Transport and the Commonwealth Bureau of Roads attended the discussions on the Australian Roads Survey 1969/74, the uniform traffic counting programme, and highway cost allocation studies.

The intermediate (45th) meeting of NAASRA was also held in Melbourne. Progress on items discussed at the preceding annual meeting was reported together with items concerning the conditions of engagement of consulting engineers for road design, planning for conversion to the metric system of weights and measures, vehicle loadings and dimensions, vehicle registration and taxation, and the servicing of plant.



*The 45th meeting of N.A.A.S.R.A. held in Melbourne during May, 1971.*

## AUSTRALIAN ROAD RESEARCH BOARD

The Australian Road Research Board is composed of the Heads of the State Road Authorities and of the Commonwealth Department of Works. Contributions from each of these authorities finance the ARRB's operations.

The breadth of the ARRB's research programme is indicated by the activities of the various specialist committees. Separate committees have been formed to conduct research into pavements, structural analysis and design, bituminous materials, structures, compaction, soil stabilization, road transport planning, traffic engineering, human factors, local government engineering, traffic capacity, economic axle loads on pavements, economic axle loads on bridges, and brittle fractures. Research is co-ordinated by an Advisory Council representative of road engineering, transport, academic and scientific interests.

The 18th Meeting of ARRB was held under the chairmanship of Mr. I. J. O'Donnell in Melbourne on 5th November, 1970. The principal items on the agenda concerned research staff requirements, collection of overseas information, review of the research programme and of the operations of the various committees, and preliminary planning for future conferences and colloquia.

The 19th Meeting, also under Mr. O'Donnell's chairmanship, was held in Melbourne on 11th and 12th May, 1971. Reports on all projects in the current research and development programme were presented and proposals for new projects and the extension of the five year plan were considered.

During the financial year 1970-71 approximately \$1,140,000 was expended on seventy-five research projects carried out by the staff of the ARRB or by University research staff under ARRB direction.

The Fifth Biennial Conference was held in Canberra, from 24th to 29th August, 1970. The Country Roads Board was represented by the Chairman, Mr. I. J. O'Donnell, and by a number of engineers, seven of whom presented papers.

A symposium on "Compaction and Stabilization" was conducted by the ARRB at Lismore, NSW, on 7th and 8th May, 1971, attended by municipal and other engineers from many areas of Victoria, New South Wales and Queensland. Papers were presented by Country Roads Board engineers.

Work on the new Australian Road Research Centre at Vermont, City of Nunawading, is proceeding on schedule. During the past year the earthworks and road construction were completed. A contract for construction has been let, and building will commence early in the 1971-72 year, with completion planned for May/June, 1972.

## CO-OPERATION WITH CITIZEN MILITARY FORCES

The Country Roads Board, with other Government instrumentalities, sponsors units of the Australian Army Supplementary Reserve to provide specialist engineering construction capacity for the Citizen Military Forces. These units form part of 6 Construction Group which, since 1st July, 1970, has been commanded by Col. J. A. McDonald, E.D., Shire Engineer, Shire of Eltham.

The units concerned — Headquarters 22 Construction Regiment, 104 Construction Squadron, and 107 Plant Squadron (Light) — continue to increase in strength and improve in skill. Approximately 170 Country Roads Board personnel attended the 1970 Annual Camp at Puckapunyal, where they trained in the use of modern military bridging equipment and practised basic military skills.

The training received was shown to great practical advantage by serving and ex-members of 22 Construction Regiment employed in the Board's Bairnsdale Division who were called upon to construct a Bailey bridge across the Snowy River at Orbost to restore road communications following major flooding in East Gippsland in February, 1971.

Floodwaters in the Snowy River severely damaged the bridge on the Princes Highway at Orbost, and necessitated closure of the highway to traffic. The Bailey bridge was used to link the remaining serviceable section of the old bridge with the approach roadway.

## PERSONNEL

The Board's employment strength at 30th June, 1970, and at 30th June, 1971, was as follows:

	1970	1971
Salaried Staff	1,414	1,552
General Staff	886	890
Employees	2,302	2,357
	4,602	4,799

The salaried staff consisted of 520 professional officers, 439 technical officers and 583 administrative staff. The 3,247 general staff and employees were engaged: 1,267 on road construction, 263 on bituminous work, 249 on bridge construction, 672 on road patrol work and 796 in workshops and depots.

### Recruitment

During the year 267 new officers were recruited to the Board's staff to fill vacancies occurring due to establishment increases, resignations and retirements.

The general employment situation in Victoria during the year was such that there was no shortage of well qualified and experienced professional personnel applying for positions with the Board. For the first time for many years there was no difficulty in recruiting experienced engineers. There was some difficulty in obtaining adequately experienced road design draftsmen.

The Board continued its practice of recruiting newly qualified graduates and diplomates directly from universities and colleges of advanced education.

High schools, technical institutions and universities were again visited by officers of the Personnel Section as part of the Board's recruiting activities.

### Cadetships

At 30th June, 1971, the Board had 47 cadets at the universities and at the Royal Melbourne Institute of Technology. The cadetship scheme provides for the payment by the Board of the full amount of the cadets' fees, together with a book allowance and living allowance.

The following table shows the number of cadets in training for the various courses during the 1971 academic year:

Course	Year of Training				Total
	1st	2nd	3rd	4th	
Civil Engineering	8	5	10	14	37
Mechanical Engineering		1		1	2
Surveying		1		3	4
Science		1	2		3
Economics		1			1
	8	9	12	18	47

## Apprentices

During the year the Board recruited 18 apprentices for training in Motor Mechanics, Fitting and Turning, Structural Steel, Electrical Mechanics, Painting and Decorating.

For the first time the Board offered apprenticeships in the trade of Carpentry and Joinery and two lads were recruited. Although these apprentices will be trained in all facets of the trade their training will be directed towards specialising in bridge construction requirements.

At 30th June, 1971, the total number of apprentices under training was:

Trade	Apprentices
Fitting and Turning	1
Motor Mechanics	59
Electrical Mechanics	1
Painting and Decorating	1
Structural Steel	2
Carpentry and Joinery	2
Total	66

## National Service

During the year 21 young men in the Board's service were undergoing National Service training:

	1970	1971
Staff	18	19
Employees	4	2
Total	22	21

## Retirements

The following officers retired during the year after substantial service with the Board:

Staff	Classification at Time of Retirement	Years of Service
Gibbs, H. S.	Chief Engineer	41
Logan, J. J.	Divisional Accounts Clerk—Ballarat Division	23
Coulter, R. W.	Engineering Assistant—Chief Engineer's Branch	37
Phillips, M. J. (Miss)	Ledgerkeeper, Female—Accountant's Branch	43
Upton, L.	Divisional Engineer—Ballarat Division	31
Holt, R. H.	Officer in Charge, Claims Section—Accountant's Branch	45
Lester, T. C.	Principal Title Survey Officer	20
Starling L. J.	Engineering Assistant—Bairnsdale Division	41
<b>General Staff</b>		
Armstrong, D. E.	Patrolman—Ballarat Division	28
Barrett, L.	Attendant	29
Ralph, E. R.	Carpenter—Mechanical Sub-branch	37
Kierce, J. B.	Overseer—Ballarat Division	46
Malcolmson, E. J.	Overseer—Bridge Sub-branch	28
Beggs, T. H.	Overseer	34
Howard, E.	Overseer	23
Haydon, W. W. T.	Roadmaster—Benalla Division	26
Heard, T. H.	Patrolman—Warrnambool Division	31

It is with regret that the death of the following personnel of many years service is recorded:

Seears, A. C. B.	Patrolman—Bairnsdale Division	21
Kesper, K. G.	Roadmaster—Bendigo Division	42
Williams, T.	Overseer—Traralgon Division	21
Evans, R.	Patrolman—Geelong Division	34

## Industrial Relations

Many claims for increased wages and salaries were made on the Board during the year by trade unions and staff associations.

Significant salary and wage increases awarded during the year were:

- (a) a 15% increase to the Board's and other State Government employers' professional engineers involving the Board in additional expenditure of approximately \$400,000 per annum. This increase was preceded some twelve months earlier by increases ranging from 11% to 15%;

- (b) a 9% increase to the Board's administrative, technical and supervisory personnel involving the Board in additional expenditure of approximately \$550,000 per annum;
- (c) an increase of 6% in the total wage arising out of the National Wage Case 1970. In a full year this increase is estimated to cost the Board an additional \$1,250,000;
- (d) increases varying from 5.5% to 12.5% to personnel affiliated with the Australian Workers Union and the Transport Workers Union involving the Board in an additional expenditure at the rate of approximately \$750,000 per annum.

Apart from the above matters which resulted from the processes of conciliation and arbitration the State Government authorised additional payments costing \$150,000 in a full year for employees under the State Incremental Payments Scheme.

## **Training**

The National Conference on Training for Labour and Industry which was held in Canberra in May, 1971, emphasised the importance of training in maintaining Australia's place as an industrially advanced country. The Board was represented at this conference by Mr. R. Billinge, Principal Training Officer. Detailed comments were submitted on the Board's training experience to assist the conference in its deliberations.

The Board's training activities endeavour to provide for the needs of a growing organization in terms of work skills and for the personal development of the Board's personnel.

A comprehensive in-service training programme was pursued in 1970/71 which included induction courses for new staff, technical training in such subjects as road design, job management, bituminous work, materials and computer methods, courses for administrative officers to improve their knowledge of the Board and to assist in their personal development, and courses on communication.

Over 150 officers, apart from those studying in their own time, were given study leave to undertake studies in engineering, applied science, surveying, arts, business studies, drafting and other courses which have a direct relationship with the Board's work.

In co-operation with the National Association of Australian State Road Authorities and the Department of Foreign Affairs, the Board provided training for sixteen Asian engineers and overseers visiting Australia under the Colombo Plan.

The following external courses were attended by selected officers of the Board:

The Australian Administrative Staff College:

Advanced Course (Mr. W. Brake and Mr. N. Guerin);

The University of New South Wales:

Traffic Planning and Control Course (Mr. A. M. Noble, Mr. I. Rennick and Mr. I. L. Mackintosh)

Construction Management Course (Mr. D. J. Nicholson)

Government Administrative Staff Course (Mr. P. E. Bourke);

The University of Melbourne:

Summer School of Business Administration (Mr. W. N. Thomas).

## **FILMS, PHOTOGRAPHY AND DISPLAYS**

During the year films, colour transparencies, and photographic prints in colour and black and white were prepared for use by the Press, for the production of technical and general publications, and for exhibition at displays throughout Victoria. For public information purposes, technical conferences, and training courses there were 104 screenings of cine films, 43 slide screenings, and 50 screenings using overhead projectors or other visual aids.

Further applications of photography to engineering problems were developed in the areas of driver's eye height simulation on models of roads and bridges, and macro photographs of wear on the reflective surfaces of white traffic markings.

Approximately one thousand photographic assignments were carried out in the year, resulting in the production of some 40,000 photographic prints.

The Board's display at the 1970 Royal Agricultural Show included exhibits of equipment used to produce models of road proposals, the testing of glass bead samples, and magnifications of microscopic sections of roadmaking stone.

During March, 1971, the Board entered an exhibit at the International Motor Show. The main theme was the retro-reflective properties of road signs and pavement markings. A series of miniature road signs under simulated night driving conditions attracted many viewers. A recorded message relayed through telephone handsets explained the main features of the display.





**Widening in progress on the Bright - Tawonga Road, Shire of Bright**

**Calder Freeway at Elphinstone**

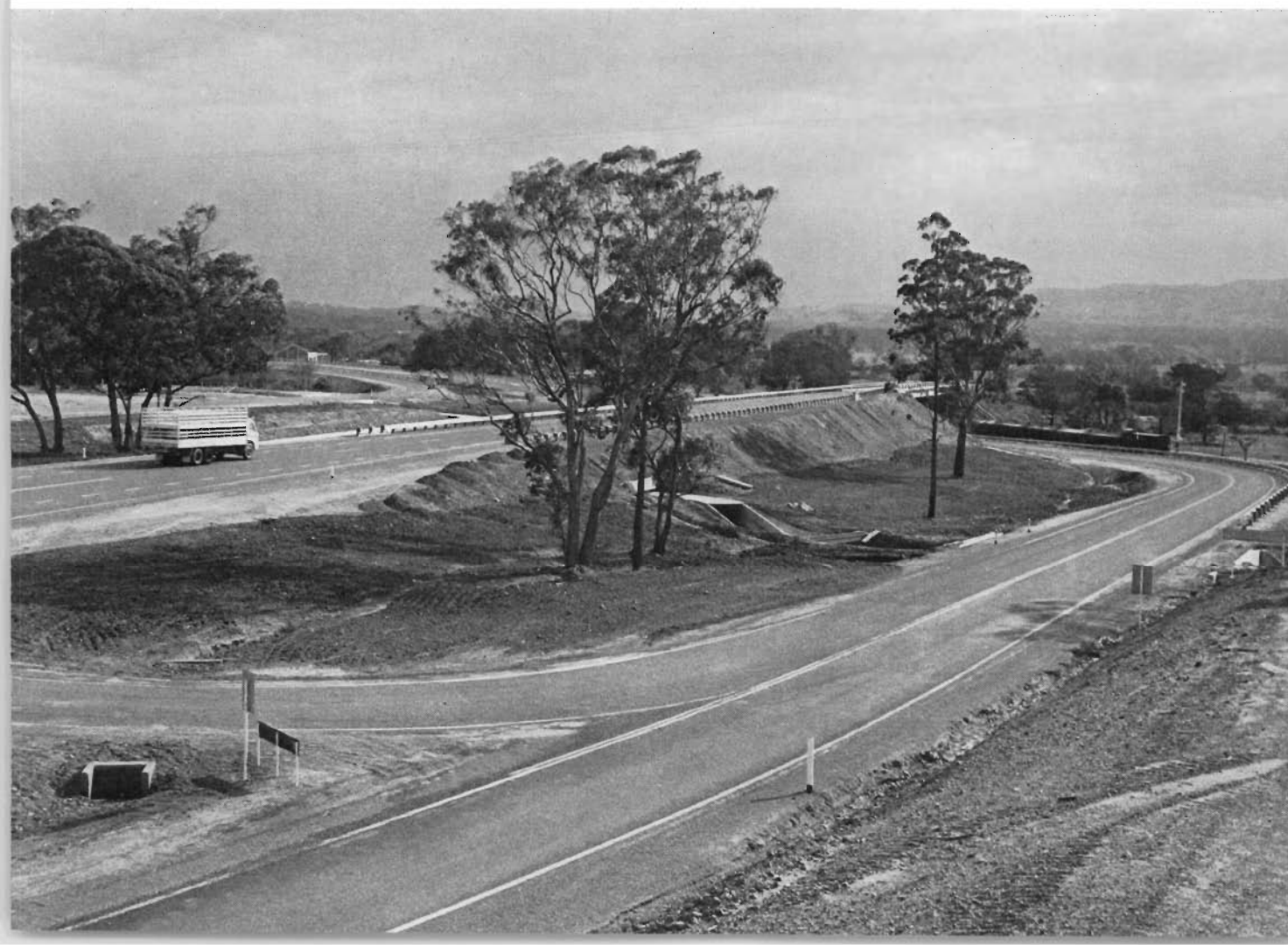



**The Lower Yarra Freeway at the interchange with Princes Highway West**

**Work in progress on the Western Freeway (Gordon Section)**





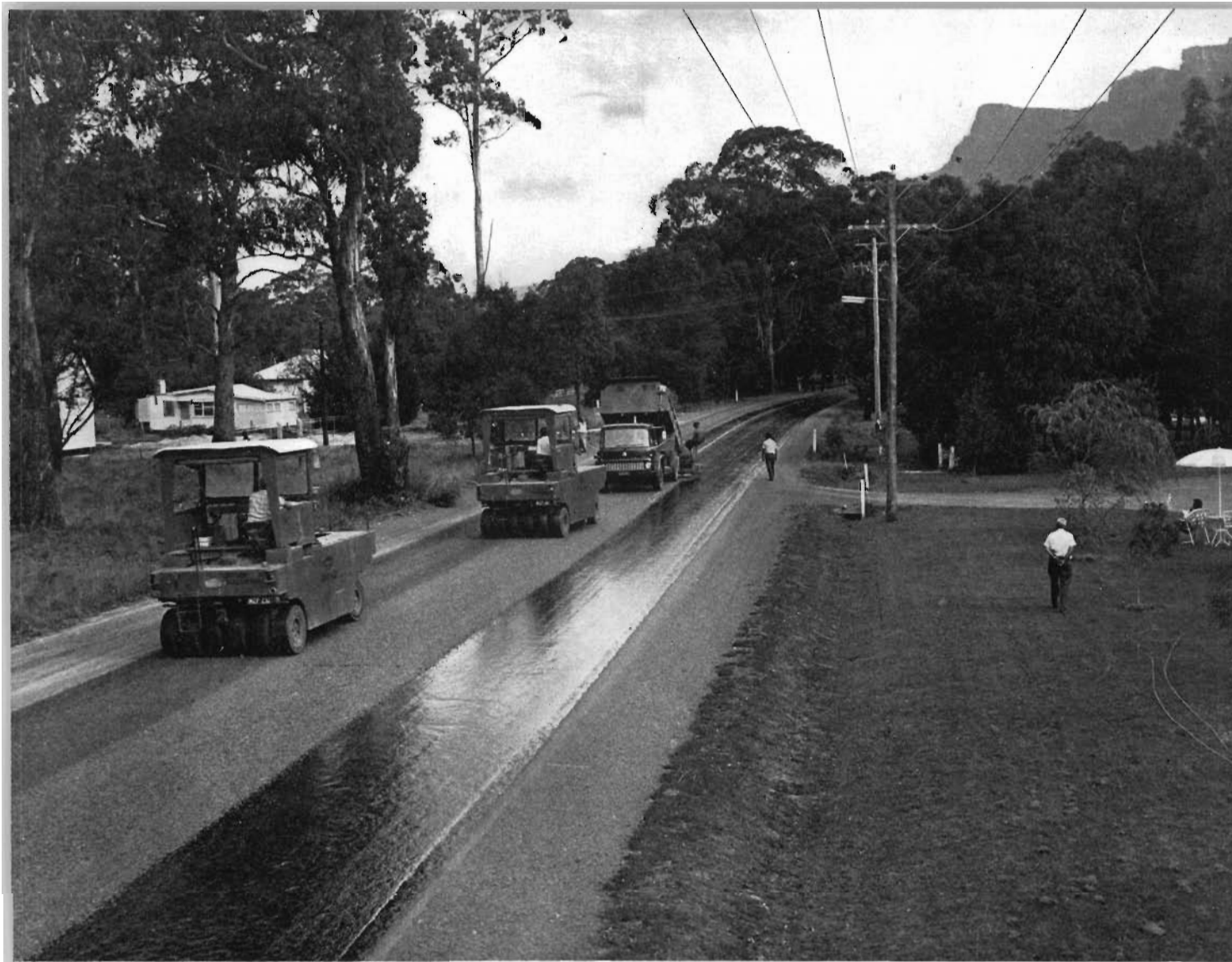

Grampians Tourists' Road  
at Halls Gap



Linemarker on the  
Lower Yarra Freeway



Dual carriageways constructed on the Princes Highway at Sale

Dual carriageways constructed on the Princes Highway at the Warrigal Road intersection

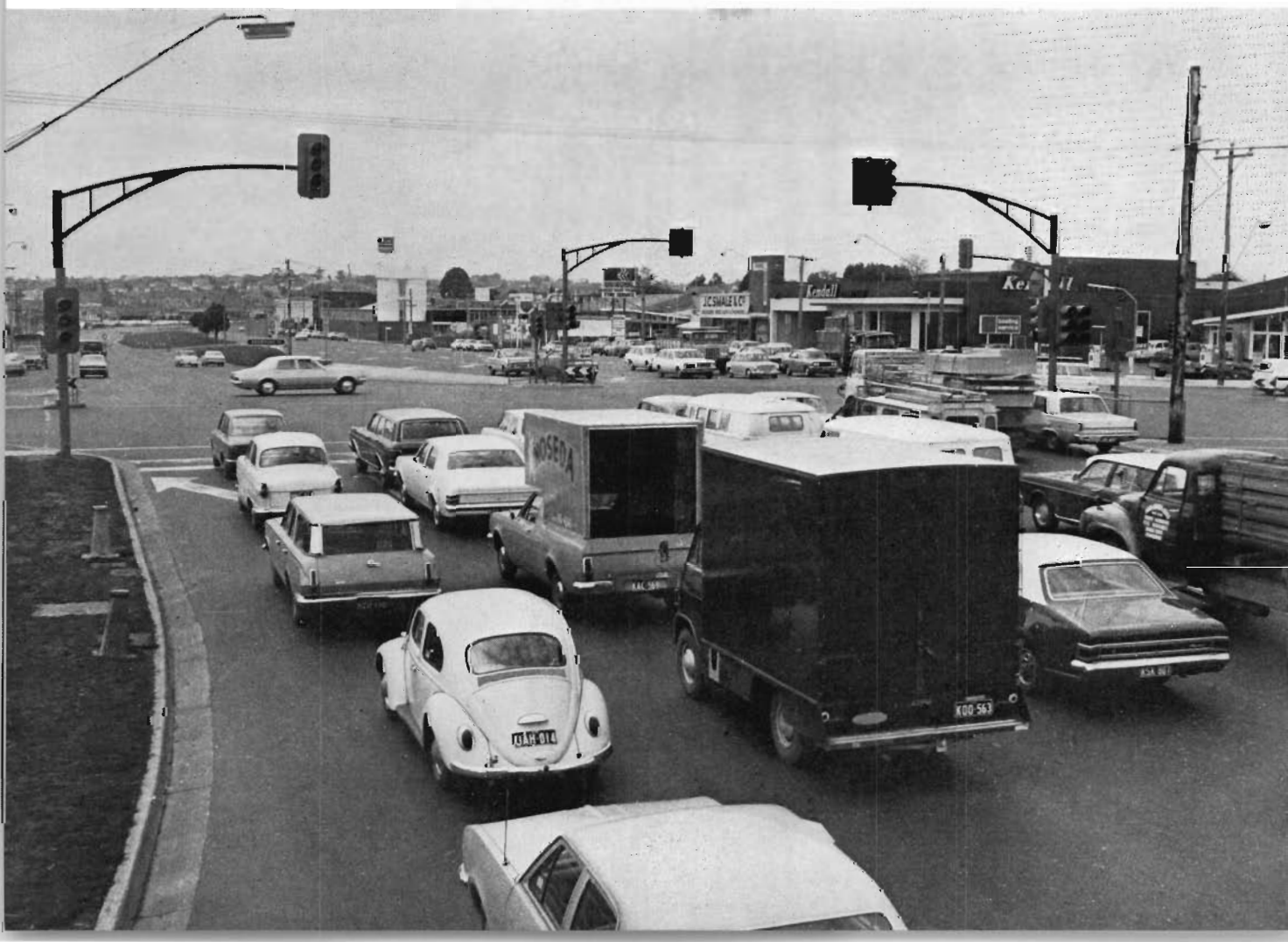

STATE HIGHWAYS AND FREEWAYS

SIGNIFICANT WORKS COMPLETED DURING FINANCIAL YEAR 1970/71

**CALDER FREEWAY**

METCALFE SHIRE

Construction of 2.0 miles on a new alignment and a railway overpass to avoid the existing level crossing at Elphinstone.

**CALDER HIGHWAY**

NEWHAM AND WOODEND SHIRE

Strengthening and redecking the bridge over the railway at Woodend.

KYNETON SHIRE

Strengthening and redecking the bridge over the railway at Malmsbury.

KORONG SHIRE

Construction of a reinforced concrete bridge 83 feet long, 28 feet between kerbs, to replace a timber bridge over Hope Creek.

CHARLTON SHIRE

Reconstruction of 5.7 miles north of Charlton to provide a sealed pavement 24 feet wide.

WALPEUP SHIRE

Reconstruction of 3.5 miles west of Mittyack to provide a sealed pavement 24 feet wide.

**CANN VALLEY HIGHWAY**

ORBOST SHIRE

Reconstruction of 1.9 miles south of Weeragua to provide a sealed pavement 20 feet wide.

Construction of a reinforced concrete bridge 92 feet long, 28 feet between kerbs, over Flat Rock Creek.

**GLENELG HIGHWAY**

GLENELG SHIRE

Reconstruction, realignment and primer-sealing of 4.5 miles east of Strathdownie to provide a sealed pavement 24 feet wide.

**GOULBURN VALLEY HIGHWAY**

NUMURKAH SHIRE

Reconstruction of 2.7 miles between Numurkah and Katunga to provide a sealed pavement 24 feet wide.

SHEPPARTON SHIRE

Widening the reinforced concrete bridge over Seven Creeks south of Shepparton to 28 feet between kerbs.



*Bridge over Seven Creeks on the Goulburn Valley Highway which was widened to 28 feet between kerbs.*

SHEPPARTON CITY

Reconstruction of 1.0 mile north of Balaclava Road to provide a sealed pavement 24 feet wide.

YEA SHIRE

Construction of a reinforced concrete bridge 150 feet long, 28 feet between kerbs, on a new alignment over the Yea Backwater, and construction of approaches to provide a sealed pavement 24 feet wide.

Realignment of 3.0 miles between Cottons Pinch and Molesworth to provide a sealed pavement 24 feet wide.

### HAMILTON HIGHWAY

BANNOCKBURN SHIRE

Reconstruction of 2.1 miles west of Fyansford to provide a sealed pavement 24 feet wide.

COLAC SHIRE

Reconstruction of 2.7 miles east of Cressy to provide a sealed pavement 24 feet wide.

HAMPDEN SHIRE

Reconstruction of 2.3 miles west of Duverney to provide a sealed pavement 24 feet wide.

MOUNT ROUSE SHIRE

Reconstruction of 2.3 miles west of Caramut to provide a sealed pavement 24 feet wide.

### HENTY HIGHWAY

HAMILTON CITY

Widening the bridge over the Grange Burn Creek south of Hamilton to 28 feet between kerbs.



*Henty Highway bridge over Grange Burn Creek showing widened section.*

DUNDAS SHIRE

Reconstruction of 3.1 miles north of Cavendish to provide a sealed pavement 24 feet wide.

WARRACKNABEAL SHIRE

Improvements to the railway level crossing in Warracknabeal, including installation of flashing lights and channelisation at the intersections with Stawell Road and the Borung Highway.

### HUME FREEWAY

SEYMOUR SHIRE

Construction of 3.0 miles of dual carriageways to by-pass the township of Tallarook.

### HUME HIGHWAY

BROADMEADOWS CITY

Widening and resheeting the eastern carriageway between Anderson Road and the Drive-In Theatre, including intersection treatment at Mahoney's Road.



**SEYMOUR SHIRE**

Reconstruction of 0.5 mile to provide dual carriageways, each 24 feet wide and separated by a 16 feet wide median, on the southern approach to Seymour, including intersection treatment at the Puckapunyal turnoff.

Reconstruction of 2.0 miles of approaches to the road over rail bridge north of Seymour to provide a sealed pavement 24 feet wide.

Construction of a reinforced concrete bridge 240 feet long, 28 feet between kerbs, to replace a masonry bridge over Hughes Creek at Avenel.



*The new and old Hume Highway bridges over Hughes Creek at Avenel.*

**LODDON VALLEY HIGHWAY**

GORDON SHIRE

Construction of a reinforced concrete bridge 107 feet long, 28 feet between kerbs, to replace a timber bridge over Nine Mile Creek north of Loddon Vale.

**LOWER YARRA FREEWAY**

Construction of 4.0 miles of 8 and 6 lane freeway between the Princes Highway East, near Kororoit Creek, and Williamstown Road, Spotswood.

**MALTBY FREEWAY**

WERRIBEE SHIRE

Retreatment and resealing of both carriageways for 6.2 miles to provide sealed pavements, each 24 feet wide.

**MAROONDAH HIGHWAY**

LILLYDALE SHIRE

Reconstruction of 2.2 miles between Brushy Creek and Hull Road to provide dual carriageways, each 24 feet wide.

Reconstruction of 1.1 miles on an improved alignment east of the Warburton Highway intersection to provide a sealed pavement 24 feet wide, and including the construction of two truck checking bays for the Transport Regulation Board.



*Reconstructed section of the Maroondah Highway east of the Warburton Highway.*

**MANSFIELD SHIRE**

Reconstruction of 0.5 mile in Mansfield township to provide dual carriageways, each 24 feet wide.

**McIVOR HIGHWAY**

**BENDIGO CITY**

Reconstruction of 1.4 miles in Bendigo to provide dual carriageways, each 32 feet wide.

Construction of a bridge 25 feet long and 92 feet wide to replace a timber bridge over Grassy Flat Creek in Bendigo.

**MIDLAND HIGHWAY**

**BALLARAT, BUNGAREE  
AND CRESWICK SHIRES**

Reconstruction and realignment of 2.2 miles near Sulky to provide a sealed pavement 24 feet wide.

**CRESWICK SHIRE**

Reconstruction and realignment of 3.6 miles between Sulky and Creswick to provide a sealed pavement 24 feet wide.

Construction of 1.1 miles of approaches to the bridge over Bullarook Creek at Newlyn to provide a sealed pavement 24 feet wide.

**DAYLESFORD AND  
GLENLYON SHIRE**

Reconstruction and realignment of 2.1 miles at Mount Franklin to provide a sealed pavement 24 feet wide.



*Reconstruction of the Midland Highway in progress at Mount Franklin.*

**SHEPPARTON SHIRE**

Reconstruction of 3.6 miles east of the East Goulburn Channel to the Dookie Hills to provide a sealed pavement 24 feet wide.

**BENALLA SHIRE**

Reconstruction of 3.1 miles south of Benalla to provide a sealed pavement 24 feet wide.

Construction of a reinforced concrete bridge over Back Creek and widening the bridge over Moonee Creek, near Swanpool.

Reconstruction and realignment of 1.2 miles of approaches to the above bridges, to provide a sealed pavement 24 feet wide.

**ALBERTON SHIRE**

Reconstruction of 1.0 mile near Wonyip to provide a sealed pavement 18 feet wide.

**MURRAY VALLEY HIGHWAY**

**KERANG SHIRE**

Reconstruction of 3.1 miles east of Kerang to provide a sealed pavement 24 feet wide.

Construction of a reinforced concrete bridge 93 feet long, 28 feet between kerbs, to replace a timber and steel bridge over the Nine Mile Creek east of Kerang.

**SWAN HILL CITY**

Construction of 0.5 mile of dual carriageways, each 30 feet wide, on the northern approach to Swan Hill.

**SWAN HILL AND  
MILDURA SHIRES**

Reconstruction and realignment of 6.3 miles east of Hattah to provide a sealed pavement 18 feet wide.



*Reconstructed section of the Murray Valley Highway east of Hattah.*

**NEPEAN HIGHWAY**

**MOORABBIN CITY**

Construction of dual carriageways, each of 3 lanes, between Station Street and Wickham Road.



*Dual carriageways constructed on the Nepean Highway at Moorabbin.*

**NORTHERN HIGHWAY**

**PYALONG SHIRE**

Reconstruction of 0.8 mile on improved alignments at two abandoned level crossings south of Pyalong.

Reconstruction and realignment of 1.3 miles south of Tooborac to provide a sealed pavement 24 feet wide.

**NORTH WESTERN HIGHWAY**

**BALLARAT SHIRE**

Resurfacing with bituminous concrete for 1.5 miles on both carriageways in Howitt Street, Wendouree.

**AVOCA SHIRE**

Reconstruction and realignment of 3.4 miles between Lamplough and Avoca to provide a sealed pavement 24 feet wide.



*North Western Highway reconstructed between Lamplough and Avoca.*

**KARA KARA SHIRE**

Reconstruction and realignment of 7.3 miles north of Stuart Mill to provide a sealed pavement 24 feet wide.



*Reconstructed section of the North Western Highway north of Stuart Mill.*

**OMEO HIGHWAY**

**OMEO SHIRE**

Reconstruction of 2.5 miles north of Swifts Creek to provide a sealed pavement 22 feet wide.



*The Omeo Highway reconstructed north of Swifts Creek.*



**TOWONG SHIRE**

Widening of 1.5 miles south of Lightning Creek to provide a formation 28 feet wide.

**OVENS HIGHWAY**

**MYRTLEFORD SHIRE**

Construction of a reinforced concrete bridge 120 feet long, 28 feet between kerbs, to replace a timber bridge over the Barwidgee Creek, and construction of approaches.

**BRIGHT SHIRE**

Widening and strengthening of 1.6 miles at Eurobin to provide a sealed pavement 24 feet wide, in conjunction with the realignment of approaches to the railway level crossing and installation of flashing light signals.

**PRINCES FREEWAY**

**WERRIBEE SHIRE**

Widening of the multi-cell culvert on Melbourne bound carriageway to three lanes, and the bridge on Geelong bound carriageway, over Skeleton Creek near Laverton.

**PRINCES HIGHWAY EAST**

**MALVERN AND OAKLEIGH CITIES**

Construction of dual carriageways, each of 3 lanes, between Castlebar Road and Ferntree Gully Road, including duplication of Warrigal Road between Dalgety Street and Castlebar Road.

**TRARALGON SHIRE**

Reconstruction and regrading of 2.3 miles west of Flynn to provide a sealed pavement 24 feet wide.

**SALE CITY**

Reconstruction of 0.7 mile in Sale to provide dual carriageways, each 24 feet wide.

**BAIRNSDALE SHIRE**

Reconstruction of 1.7 miles east of Bairnsdale to provide a sealed pavement 24 feet wide.

**TAMBO SHIRE**

Reconstruction and realignment of 0.9 mile at Bosses Swamp near Nicholson to provide a sealed pavement 24 feet wide.

**ORBOST SHIRE**

Flood damage repairs to 1.8 miles of highway and to the bridge over the Snowy River at Orbost.

Flood damage repairs over a distance of 40 miles from Cann River to the State border.

**PRINCES HIGHWAY WEST**

**SOUTH BARWON SHIRE**

Construction of 2.4 miles of dual carriageways, each 24 feet wide, from Settlement Road to Waurin Ponds Creek.

**HEYTESBURY SHIRE**

Strengthening 1.2 miles at Stoneyford to provide a sealed pavement 24 feet wide.

**WARRNAMBOOL CITY**

Construction of 0.6 mile of dual carriageways, each 24 feet wide, in Warrnambool.

Construction of 0.2 mile of the northern carriageway in Warrnambool to provide a sealed pavement 44 feet wide.



*Dual carriageways constructed on the Princes Highway West at Warrnambool.*

## **PYRENEES HIGHWAY**

NEWSTEAD SHIRE

Reconstruction and realignment of approaches to the railway level crossing west of Newstead to provide a sealed pavement 24 feet wide.

TULLAROOP SHIRE

Widening of 3.0 miles east of Moolort to provide a sealed pavement 24 feet wide.

AVOCA SHIRE

Reconstruction and realignment of 3.4 miles between Avoca and Amphitheatre to provide a sealed pavement 24 feet wide.

## **SOUTH GIPPSLAND HIGHWAY**

CRANBOURNE SHIRE

Widening and resheeting 1.2 miles south-east of the Baxter-Tooradin Road to provide a sealed pavement 24 feet wide.

Widening and resheeting 0.4 mile east of Tooradin, including approaches to the bridge over Moody's Inlet, to provide a sealed pavement 24 feet wide.

Widening 0.8 mile and resheeting 0.5 mile, including intersection treatment at the Healesville-Koo Wee Rup Road, to provide a sealed pavement 24 feet wide.

Widening and resheeting 1.4 miles, including reconstruction of the Yallock Creek Floodway, to provide a sealed pavement 24 feet wide.

KORUMBURRA SHIRE

Reconstruction of 0.8 mile between Bena and Loch to provide a sealed pavement 24 feet wide.



*Reconstructed section of the South Gippsland Highway between Bena and Loch.*

SOUTH GIPPSLAND SHIRE

Reconstruction of 0.9 mile near Stony Creek to provide a sealed pavement 24 feet wide.

Reconstruction of 1.0 mile near Franklin River to provide a sealed pavement 24 feet wide.

ALBERTON SHIRE

Construction of a reinforced concrete bridge over Bruthen Creek at Woodside, and approaches of 0.8 mile, providing a sealed pavement 24 feet wide.

Widening and strengthening 2.5 miles north of Woodside to provide a sealed pavement 24 feet wide.

## **WARBURTON HIGHWAY**

LILLYDALE SHIRE

Reconstruction of 1.5 miles between Seville and Killara Hill to provide a sealed pavement 24 feet wide and 34 feet wide on climbing lanes.

UPPER YARRA SHIRE

Reconstruction and realignment of 1.6 miles east of Woori Yallock to provide a sealed pavement 24 feet wide.

## WESTERN HIGHWAY

### SUNSHINE CITY

Widening and resheeting the southern carriageway to 3 lanes between Duke Street and Hampshire Road.

Widening and resheeting the northern carriageway to 3 lanes between McIntyre Road and Duke Street.

## WIMMERA HIGHWAY

### KOWREE SHIRE

Reconstruction and realignment of 3.5 miles east and west of Apsley to provide a sealed pavement 24 feet wide.

## APPENDIX 2

### TOURISTS' ROADS AND FOREST ROADS

SIGNIFICANT WORKS COMPLETED DURING FINANCIAL YEAR 1970/71

#### TOURISTS' ROADS

##### ALPINE ROAD

Reconstruction and realignment of 1.2 miles at Powerline Gully to provide a formation 28 feet wide.

Widening 0.6 mile at Mt. Blowhard to provide a formation 25 feet wide.

##### BOGONG HIGH PLAINS ROAD

Reconstruction and sealing of 2.4 miles between Howman's Gap and Falls Creek to provide a sealed pavement 31 feet wide, including provision for parking.



*The Bogong High Plains Road reconstructed and sealed at Falls Creek.*

##### DONNA BUANG ROAD

Reconstruction and realignment of 2.0 miles between the Ten Mile Turntable and the Summit to provide a sealed pavement 24 feet wide.

Reconstruction and realignment of 2.0 miles between Panton's Gap and Don Gap to provide a sealed pavement 24 feet wide.

##### MT. BUFFALO ROAD

Reconstruction for future sealing of 1.7 miles between Dingo Dell and the Cathedral to provide a formation 25 feet wide.

##### MT. BULLER ROAD

Reconstruction and sealing of 2.8 miles east of Mirrimbah to provide a sealed pavement 20 feet wide.

##### MT. DANDENONG ROAD

Widening and resheeting 0.9 mile between Wantirna-Sassafras Road and Perrins Creek Road to provide a sealed pavement 24 feet wide.

MARYSVILLE-WOODS  
POINT ROAD

Reconstruction and realignment of 1.9 miles between Marysville and Robley's Saddle to provide a sealed pavement 20 feet wide.

OCEAN ROAD

Reconstruction of 1.1 miles between Reedy Creek and Stony Creek, east of Lorne, to provide a sealed pavement 24 feet wide.

Reconstruction and realignment of 4.9 miles south of Lavers Hill to provide a sealed pavement 20 feet wide.

Reconstruction and realignment of 1.4 miles as Sparks Gully, east of Port Campbell, to provide a sealed pavement 20 feet wide.

WILSONS  
PROMONTORY ROAD

Reconstruction of 2.6 miles near Darby River to provide a sealed pavement 20 feet wide.

**FOREST ROADS**

BRUTHEN-BUCHAN  
ROAD

Reconstruction and realignment of 0.5 mile at Mississippi Corner to provide a sealed pavement 20 feet wide.

Reconstruction of 0.4 mile at Flourbag Hill to provide a sealed pavement 20 feet wide.

DEAN MARSH-LORNE  
ROAD

Reconstruction and realignment of 0.7 mile near Lorne to provide a sealed pavement 18 feet wide.

GREENDALE-  
TRENTHAM ROAD

Reconstruction and realignment of 1.5 miles between Blackwood and Barry's Reef to provide a sealed pavement 22 feet wide.

LAVERS HILL-COBDEN  
ROAD

Reconstruction and realignment of 0.5 mile to provide a sealed pavement 18 feet wide.

WALHALLA ROAD

Reconstruction of 0.7 mile between Erica and the Thompson River to provide a gravelled pavement 22 feet wide.

WARBURTON-WOODS  
POINT ROAD

Reconstruction of 9.1 miles from Monty's Hut to St. Clair to provide a gravelled pavement 20 feet wide.

## APPENDIX 3

### MAIN ROADS

SIGNIFICANT WORKS COMPLETED DURING FINANCIAL YEAR 1970/71

#### BAIRNSDALE DIVISION

MAFFRA SHIRE Traralgon-Maffra Road—Construction of a reinforced concrete bridge 71 feet long, 28 feet between kerbs, over Wickhams Creek, and construction of approaches.

TAMBO SHIRE Gelantipy Road—Reconstruction of 1.2 miles near W Tree Creek to provide a formation 26 feet wide.

#### BALLARAT DIVISION

CRESWICK SHIRE Castlemaine-Ballarat Road—Construction of a 3 span reinforced concrete bridge 106 feet long, 24 feet between kerbs, to replace an old concrete bridge over Deep Creek at Campbelltown.

DAYLESFORD AND  
GLENLYON SHIRE Ballan Road—Reconstruction and realignment of 0.6 mile at Stoney Creek to provide a sealed pavement 24 feet wide.

NEWHAM AND  
WOODEND SHIRE Mt. Macedon Road—Widening of 1.3 miles to provide a sealed pavement 18 feet wide.

RIPON SHIRE Beaufort-Amphitheatre Road—Reconstruction of 1.8 miles to provide a sealed pavement 22 feet wide.

TALBOT AND  
CLUNES SHIRE Maryborough-Ballarat Road—Construction of 1.4 miles, on a new alignment around the township of Talbot, to provide a sealed pavement 22 feet wide.

TULLAROOP SHIRE Talbot-Eddington Road—Widening 4.5 miles to provide a sealed pavement 20 feet wide.

#### BENALLA DIVISION

ALEXANDRA SHIRE Buxton-Marysville Road—Reconstruction of 1.9 miles south of the Maroonah Highway to provide a sealed pavement 20 feet wide.

BEECHWORTH SHIRE Beechworth Road—Reconstruction of 1.0 mile to provide a sealed pavement 20 feet wide.

BRIGHT SHIRE Bright-Tawonga Road—Reconstruction and sealing of 2.5 miles to provide a sealed pavement 20 feet wide.

MYRTLEFORD SHIRE Happy Valley Road—Construction of a reinforced concrete bridge, 28 feet between kerbs, to replace a timber bridge over the Havilah Creek.

OXLEY SHIRE Mansfield-Whitfield Road—Reconstruction and sealing of 1.0 mile to provide a sealed pavement 18 feet wide.

TOWONG SHIRE Yabba Road—Reconstruction and realignment of 2.0 miles south of Tallangatta to provide an unsealed pavement 20 feet wide.

WANGARATTA CITY Wangaratta-Kilfeera Road—Construction of a reinforced concrete bridge 66 feet long, 28 feet between kerbs, over One Mile Creek and construction and sealing of approaches.

YACKANDANDAH SHIRE

Yackandandah-Wodonga Road—Reconstruction, realignment and sealing of 0.8 mile to provide a sealed pavement 20 feet wide.

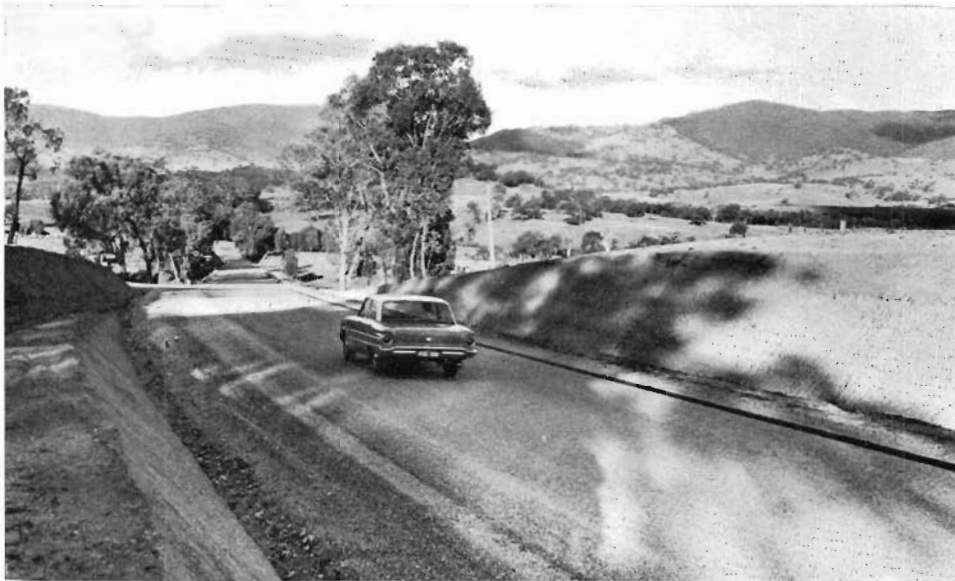

*Reconstructed section of the Yackandandah-Wodonga Road, Yackandandah Shire.*

YEA SHIRE

Whittlesea-Yea Road—Reconstruction, realignment and sealing of 1.0 mile to provide a sealed pavement 22 feet wide.

Yarra Glen-Yea Road—Reconstruction and sealing of 2.0 miles to provide a sealed pavement 22 feet wide.

**BENDIGO DIVISION**

CHARLTON SHIRE

St. Arnaud Road—Widening and sealing 6.2 miles to provide a sealed pavement 22 feet wide.

COHUNA SHIRE

Cohuna-Koondrook Road—Reconstruction and sealing of 1.7 miles to provide a sealed pavement 24 feet wide.

EAST LODDON SHIRE

Bendigo-Pyramid Road—Widening and sealing 4.0 miles to provide a sealed pavement 22 feet wide.

GORDON SHIRE

Boort-Kerang Road—Reconstruction and sealing of 1.5 miles to provide a sealed pavement 22 feet wide.

MALDON SHIRE

Maldon-Lockwood Road—Widening and sealing of 2.0 miles to provide a sealed pavement 22 feet wide.

METCALFE SHIRE

Kyneton-Redesdale Road—Reconstruction and sealing of 2.2 miles to provide a sealed pavement 22 feet wide.

PYALONG SHIRE

Lancefield-Tooborac Road—Construction of a reinforced concrete bridge 90 feet long, 28 feet between kerbs, and construction of 0.5 mile of approaches to provide a sealed pavement 22 feet wide.

STRATHFIELDSAYE SHIRE

Mandurang Road—Reconstruction and sealing of 1.5 miles to provide a sealed pavement 24 feet wide.

SWAN HILL SHIRE

Donald-Swan Hill Road—Reconstruction and sealing of 4.4 miles to provide a sealed pavement 20 feet wide.

**DANDENONG DIVISION**

BERWICK SHIRE

Healesville-Koo Wee Rup Road—Reconstruction of 1.2 miles to provide a sealed pavement 18 feet wide.

CRANBOURNE SHIRE

Cranbourne-Frankston Road—Reconstruction of 1.3 miles to provide a sealed pavement 24 feet wide.

Dandenong-Hastings Road—Reconstruction of 1.1 miles to provide a sealed pavement 24 feet wide.

DONCASTER AND  
TEMPLESTOWE CITY

Heidelberg-Doncaster Road—Construction of 0.8 mile of dual carriageways, each 30 feet wide, and construction of the intersection with Thompsons Road.

ELTHAM SHIRE

Eltham-Yarra Glen Road—Construction of 0.6 mile of dual carriageways, each 28 feet wide, from Para Road to Looker Road.

Whittlesea-Kinglake Road—Reconstruction and sealing of 1.0 mile, between Pheasant Creek and Ganglehoff Road, to provide a sealed pavement 21 feet wide.



*Dual carriageways constructed on the Eltham-Yarra Glen Road, Eltham Shire.*

FLINDERS SHIRE

Frankston-Flinders Road—Reconstruction of 1.1 miles to provide a sealed pavement 20 feet wide.

HASTINGS SHIRE

Dandenong-Hastings Road—Reconstruction of 1.2 miles to provide a sealed pavement 24 feet wide.

HEALESVILLE SHIRE

Marysville Road—Reconstruction of 0.5 mile to provide a sealed pavement 20 feet wide.

KNOX CITY

Stud and Waverley Roads—Reconstruction of the intersection.

RINGWOOD CITY

Canterbury and Wantirna Roads—Reconstruction of the intersection.

SHERBROOKE SHIRE

Monbulk Road—Construction of dual carriageways, each 30 feet wide, in Station Street and Collier Avenue, Upwey.

Wellington Road—Construction of 1.7 miles on a new alignment around the Cardinia Creek Storage Reservoir.

SPRINGVALE CITY

Springvale Road—Construction of 2.0 miles of dual carriageways, each 32 feet wide, and construction of the intersection with Heatherton Road.

WAVERLEY CITY

Springvale Road—Construction of 1.0 mile of dual carriageways, each 31 feet wide.

## GEELONG DIVISION

### BACCHUS MARSH SHIRE

Geelong-Bacchus Marsh Road—Reconstruction and realignment of 0.9 mile to provide a sealed pavement 24 feet wide and to eliminate two rail crossings.

### LEIGH SHIRE

Gisborne Road—Reconstruction of 2.3 miles to provide a sealed pavement 20 feet wide.

### SOUTH BARWON SHIRE

Inverleigh-Shelford Road—Reconstruction and realignment of 1.3 miles to provide a sealed pavement 18 feet wide.

Torquay Road—Reconstruction of 0.4 mile to provide dual carriageways, each 24 feet wide, between Waurm Ponds Creek and Grovedale.

### WINCHELSEA SHIRE

Torquay Road—Construction of a duplicate reinforced concrete bridge over Waurm Ponds Creek.

Birregurra-Dean Marsh Road—Reconstruction of 2.4 miles to provide a sealed pavement 20 feet wide.

## HORSHAM DIVISION

### BIRCHIP SHIRE

Beulah-Birchip-Wycheproof Road—Reconstruction and sealing of 2.0 miles east of Birchip to provide a sealed pavement 22 feet wide.

### DONALD AND DUNMUNKLE SHIRES

Marnoo-Donald Road—Construction of a reinforced concrete bridge and approaches over the Richardson River.

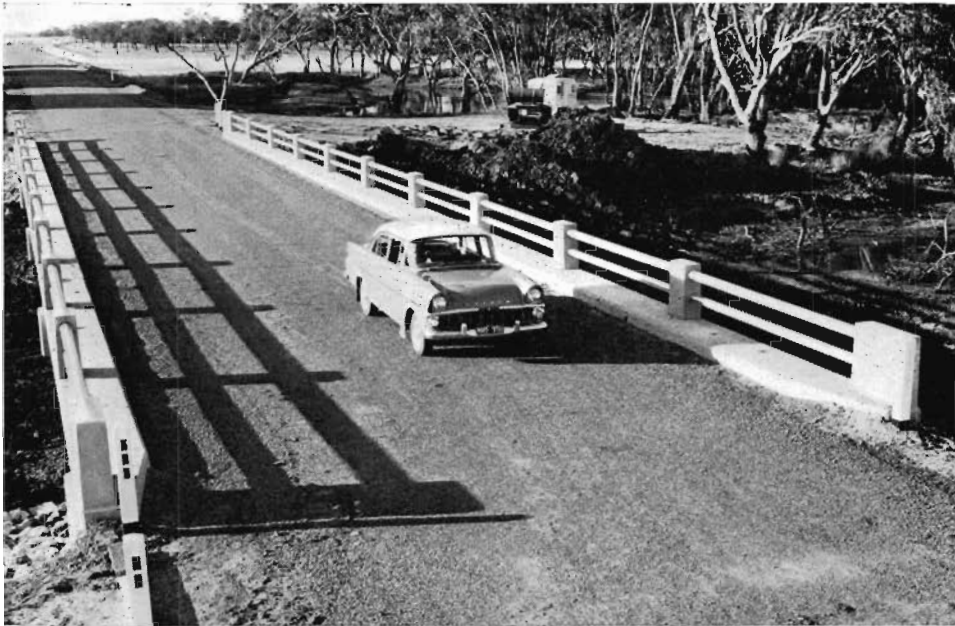

*Marnoo-Donald Road—New bridge over Richardson River, Donald and Dunmunkle Shires.*

### DUNMUNKLE SHIRE

Horsham-Lubeck Road—Construction of two reinforced concrete bridges over Wimmera River and Mount William Creek to replace three timber bridges.

### KOWREE SHIRE

Kaniva-Edenhope Road—Widening and sealing 3.8 miles to provide a sealed pavement 18 feet wide.

### STAWELL SHIRE

Glenorchy-Horsham Road—Construction and sealing of 1.7 miles to provide a sealed pavement 12 feet wide.

### STAWELL TOWN

Ararat-Stawell Road—Reconstruction and sealing of 1.3 miles, including channelisation at the intersection with Western Highway, to provide a sealed pavement 24 feet wide.

### WIMMERA SHIRE

Horsham-Wal Wal Road—Construction of a reinforced concrete bridge, 24 feet between kerbs, to replace a timber bridge over Middle Creek.

### WYCHEPROOF SHIRE

Woomelang-Sea Lake Road—Widening and sealing 6.7 miles to provide a sealed pavement 20 feet wide.

Boort-Wycheproof Road—Widening and sealing 4.5 miles to provide a sealed pavement 20 feet wide.



## **METROPOLITAN DIVISION**

BRIGHTON CITY	South Road—Construction of dual carriageways between New Street and Beach Road, including installation of boom barriers at the railway level crossing and channelisation at the intersection at Beach Road.
HAWTHORN CITY	Barkers Road—Reconstruction and sealing between Denmark Street and Glenferrie Road.
PORT MELBOURNE CITY	Beach Road—Construction of dual carriageways on a new alignment between Pickles Street and Bay Street.
ST. KILDA CITY	Beach Road—Construction on a new alignment across Shelley Reserve between Shelley Street and Normandy Road.
WHITTLESEA SHIRE	Whittlesea Road—Reconstruction and realignment of 0.5 mile to provide a sealed pavement 24 feet wide.

## **TRARALGON DIVISION**

KORUMBURRA SHIRE	Bena-Poowong Road—Reconstruction and realignment of 0.9 mile to provide a sealed pavement 22 feet wide.
MORWELL SHIRE	Morwell-Thorpdale Road—Reconstruction and realignment of 1.6 miles to provide a sealed pavement 20 feet wide.
SOUTH GIPPSLAND SHIRE	O'Grady's Ridge Road—Reconstruction and realignment of 1.3 miles to provide a gravelled pavement 22 feet wide.
WARRAGUL SHIRE	Bloomfield Road—Reconstruction and realignment of 1.0 mile at Nilma to provide a sealed pavement 18 feet wide.
WOORAYL SHIRE	Inverloch-Leongatha Road—Reconstruction and realignment of 1.1 miles to provide a sealed pavement 24 feet wide.

## **WARRNAMBOOL DIVISION**

DUNDAS SHIRE	Mt. Napier Road—Reconstruction and primer-sealing of 2.6 miles to provide a sealed pavement 20 feet wide. Dartmoor-Hamilton Road—Reconstruction and primer-sealing of 1.5 miles to provide a sealed pavement 20 feet wide.
GLENELG SHIRE	Casterton-Penola Road—Reconstruction and primer-sealing of 4.3 miles to provide a sealed pavement 20 feet wide.
MINHAMITE SHIRE	Warrnambool-Penshurst Road—Reconstruction and primer-sealing of 2.0 miles to provide a sealed pavement 20 feet wide.

UNCLASSIFIED ROADS

SIGNIFICANT WORKS COMPLETED DURING FINANCIAL YEAR 1970/71

BALLARAT DIVISION

BALLARAT CITY

Curtis Street—Land acquisition and construction between Peel and Humffray Streets.



*Reconstructed section of the Nagambie-Locksley Road, Goulburn Shire.*

BENALLA DIVISION

ALEXANDRA SHIRE

Whanregarwen Road—Reconstruction and realignment of 0.5 mile to provide a sealed pavement 20 feet wide.

GOULBURN SHIRE

Nagambie-Locksley Road—Reconstruction, realignment and sealing of 3.7 miles to provide a sealed pavement 12 feet wide.

MANSFIELD SHIRE

Mansfield-Howes Creek Road—Reconstruction and realignment of 1.1 miles to provide a pavement 20 feet wide.

OXLEY SHIRE

Upper King River Road—Construction of a reinforced concrete bridge 70 feet long, 24 feet between kerbs, over Stony Creek, and construction and sealing of approaches.

RUTHERGLEN SHIRE

Up River Road—Reconstruction and sealing of 3.2 miles to provide a sealed pavement 12 feet wide.

TOWONG SHIRE

Sandy Creek Road—Reconstruction and realignment of 2.4 miles to provide a pavement 19 feet wide.

UPPER MURRAY SHIRE

Back Thowgla Road—Construction of a reinforced concrete bridge 82 feet long, 24 feet between kerbs, over Thowgla Creek south-east of Corryong.

YACKANDANDAH SHIRE

Sandy Creek Road—Construction and sealing of 1.0 mile to provide a sealed pavement 18 feet wide.

BENDIGO DIVISION

COHUNA SHIRE

Cowardine's Road—Reconstruction and sealing of 2.6 miles to provide a sealed pavement 12 feet wide.

Leitchville-Kerang Road—Reconstruction and sealing of 0.9 mile to provide a sealed pavement 20 feet wide.

DEAKIN SHIRE

Trevaskis Road—Reconstruction and sealing of 2.0 miles to provide a sealed pavement 18 feet wide.

HUNTLY SHIRE	Huntly-Neilborough Road—Construction of a reinforced concrete bridge 90 feet long, 24 feet between kerbs.
KERANG BOROUGH	Nolan Street—Reconstruction and sealing of 0.6 mile to provide a sealed pavement 40 feet wide.
KERANG SHIRE	Murrabit West Road—Reconstruction and sealing of 1.5 miles to provide a sealed pavement 20 feet wide. Quambatook-Swan Hill Road—Reconstruction and sealing of 1.8 miles to provide a sealed pavement 20 feet wide. Quambatook-Boort Road—Reconstruction and sealing of 2.0 miles to provide a sealed pavement 18 feet wide.
METCALFE SHIRE	Elphinstone township streets—Reconstruction and sealing of 1.6 miles, in conjunction with the construction of the road over rail overpass, to provide a sealed pavement 22 feet wide. Faraday-Sutton Grange Road—Reconstruction and sealing of 1.7 miles to provide a sealed pavement 20 feet wide. Metcalf-Elphinstone Road—Reconstruction and sealing of 3.7 miles to provide a sealed pavement 20 feet wide.
NATHALIA SHIRE	Kempster's Bridge Road—Construction of a bridge 150 feet long, 20 feet between kerbs, over Broken Creek, and construction of approaches.
NUMURKAH SHIRE	Rendells Road—Construction and sealing of 3.2 miles to provide a sealed pavement 20 feet wide. Shinnicks and Kemp Roads—Construction and sealing of 2.5 miles to provide a sealed pavement 20 feet wide.
PYALONG SHIRE	Pyalong-Seymour Road—Construction and sealing of 1.4 miles to provide a sealed pavement 18 feet wide.
STRATHFIELDSAYE SHIRE	McIvor Highway—Construction and sealing of 1.4 miles of service road to provide a sealed pavement 16 feet wide.

#### DANDENONG DIVISION

DANDENONG CITY	Heatherton Road—Reconstruction of 0.2 mile to provide a sealed pavement 37 feet wide.
ELTHAM SHIRE	Eltham-Greensborough Road—Construction of a road over rail bridge 70 feet long, with dual carriageways each 23 feet wide, and construction of approaches.
FLINDERS SHIRE	Mornington Peninsula Freeway—Construction and sealing of 1.4 miles of service road from Ranier Avenue to Arthur's Seat Road, to provide a sealed pavement 22 feet wide.
KNOX CITY	Forest Road—Construction of 0.6 mile between Boronia Road and Old Forest Road to provide a pavement 31 feet wide.
LILLYDALE SHIRE	Hull Road—Reconstruction of 0.9 mile to provide a pavement 37 feet wide.
NUNAWADING CITY	Highbury Road—Reconstruction of 1.0 mile between Middleborough Road and Blackburn Road to provide a sealed pavement 38 feet wide. Mahoneys Road—Reconstruction of 0.8 mile north of Burwood Highway to provide a sealed pavement 38 feet between kerbs.
RINGWOOD CITY	Wonga Road—Reconstruction of 0.3 mile to provide a sealed pavement 24 feet wide.
SHERBROOKE SHIRE	Morris Road—Reconstruction of 0.6 mile to provide a sealed pavement 27 feet between kerbs.

SPRINGVALE CITY

Athol Road—Widening of 0.7 mile to provide a sealed pavement 26 feet between kerbs.

Centre Road—Widening of 0.8 mile to provide a sealed pavement 37 feet between kerbs.

Westall Road—Widening of 1.4 miles to provide a sealed pavement 22 feet wide.

WAVERLEY CITY

Blackburn Road—Widening of 0.4 mile north of Waverley Road to provide a sealed pavement 42 feet between kerbs.

Stephensons Road—Reconstruction of 0.4 mile south of Waverley Road to provide a pavement 40 feet between kerbs.



*Widened section of Blackburn Road, Waverley City.*

**GEE LONG DIVISION**

COLAC SHIRE

Heytesbury Settlement Access Roads—Construction of 2.0 miles to provide a sealed pavement 20 feet wide.

NEWTOWN CITY

Queen Park Road—Redecking and modification to increase the clearance of the Queens Park bridge over the Barwon River.

OTWAY SHIRE

Gellibrand East Road—Construction of a 3 span reinforced concrete bridge 71 feet long, 20 feet between kerbs, over Lardner's Creek.

**HORSHAM DIVISION**

ARAPILES SHIRE

Jallumba-Mockinya Road—Reconstruction and sealing of 4.8 miles to provide a sealed pavement 12 feet wide.

HORSHAM CITY

Stawell Road—Construction and sealing of 0.5 mile of service road on the Western Highway on the southern approach to Horsham.

KANIVA SHIRE

Serviceton North Road—Reconstruction and sealing of 2.8 miles to provide a sealed pavement 20 feet wide.

KARA KARA AND DONALD SHIRES

St. Arnaud-Banyena Road—Reconstruction, realignment and sealing of 1.7 miles to provide a sealed pavement 12 feet wide and 18 feet wide on curves.

KOWREE SHIRE

Newlands Settlement Road—Reconstruction and sealing of 3.9 miles to provide a sealed pavement 12 feet wide.

LOWAN SHIRE

Diapur-Yanac Road—Reconstruction and sealing of 3.8 miles to provide a sealed pavement 12 feet wide.

STAWELL SHIRE Stawell-Joel South Road—Construction and sealing of 2.1 miles to provide a sealed pavement 12 feet wide and 18 feet wide on curves.

#### METROPOLITAN DIVISION

BOX HILL CITY Riversdale Road—Reconstruction and widening between Warrigal Road and Elgar Road.

COBURG CITY Carr Street—Construction of a bridge 106 feet long, 24 feet between kerbs plus two footways, over the Merri Creek.

DIAMOND VALLEY SHIRE Para Road—Construction of a bridge 110 feet long, 28 feet between kerbs plus two footways, over the Plenty River, and construction of approaches.

FITZROY CITY Rushall Crescent—Reconstruction of 0.4 mile between Bennett and McKean Streets.

HEIDELBERG CITY Burke Road North—Reconstruction of 0.5 mile between Lower Heidelberg Road and McArthur Road.

KEW CITY Wellington Street—Reconstruction of 0.7 mile between Davis Street and Glenferrie Road.



*Reconstruction of Wellington Street, Kew City.*

#### TRARALGON DIVISION

ALBERTON SHIRE Darriman-Seaspray Road—Reconstruction and sealing of 1.6 miles near Seaspray to provide a sealed pavement 12 feet wide.

WARRAGUL SHIRE Nilma-Shady Creek Road—Reconstruction and realignment of 1.1 miles to provide a gravelled pavement 20 feet wide.

WOORAYL SHIRE Lower Tarwin-Waratah Road—Reconstruction and realignment of 1.4 miles to provide a sealed pavement 20 feet wide.

#### WARRNAMBOOL DIVISION

GLENELG SHIRE Casterton-Dartmoor Road—Reconstruction and sealing of 3.1 miles to provide a sealed pavement 12 feet wide.

MOUNT ROUSE SHIRE Glenthompson-Caramut Road—Construction of a 4 cell reinforced concrete culvert.

## APPENDIX 5

### MOTOR REGISTRATIONS

Registrations under the Motor Car Act made during the year 1970/71 totalled 1,644,422, an increase of 6.1% over the total for the previous year.

Vehicle	Financial Year 1969/70		Financial Year 1970/71		Increase	Decrease
Private—						
New	112,230		111,153			
Secondhand:						
Re-registered	35,570		38,708			
Renewed	990,896		1,060,056			
		1,138,696		1,209,917	71,221	—
Commercial and Hire—						
New	16,555		15,696			
Secondhand:						
Re-registered	4,448		4,481			
Renewed	113,327		117,207			
		134,330		137,384	3,054	—
Primary Producers' Trucks—						
New	3,566		3,213			
Secondhand:						
Re-registered	4,007		3,324			
Renewed	78,914		82,047			
		86,487†		88,584*	2,097	—
Licences under the Motor Omnibus Act		685		644	—	41
Trailers		169,103		181,618	12,515	—
Motor Cycles		19,978		26,275	6,297	—
TOTALS		1,549,279		1,644,422	95,184	41

\* Includes 46,090 no-fee tractors.

† Includes 45,147 no-fee tractors.

## APPENDIX 6

### COUNTRY ROADS BOARD

#### STATEMENT OF RECEIPTS AND PAYMENTS (TO NEAREST DOLLAR) FOR THE YEAR ENDED 30TH JUNE, 1971

	Country Roads Board Fund		Loan Funds	Commonwealth Aid Roads Act 1969						Total
	Act 6229	Act 6222 Rd. Mtce. A/c		Sec. 4(1)	Sec. 4(2)	Sec. 4(3)	Sec. 4(4)			
	\$	\$	\$	\$	\$	\$	\$	\$	\$	
<b>RECEIPTS</b>										
Balance as at 1st July 1970 .. .. .	1,201,238	..	..	..	..	..	..	..	..	1,201,238
Motor Car Act 1958 (No. 6325) .. .. .	32,512,576	..	..	..	..	..	..	..	..	
Additional Registration Fees .. .. .	2,112,175	..	..	..	..	..	..	..	..	
Drivers' Licence Fees .. .. .	808,385	..	..	..	..	..	..	..	..	
Drivers' Licence Testing Fees .. .. .	275,306	..	..	..	..	..	..	..	..	
Trailer Registration Fees .. .. .	730,757	..	..	..	..	..	..	..	..	
Examiners' Licence Fees .. .. .	8,246	..	..	..	..	..	..	..	..	
Sale of Log Books .. .. .	10,493	..	..	..	..	..	..	..	..	
	36,457,938	..	..	..	..	..	..	..	..	
Less Cost of Collection .. .. .	3,563,400	..	..	..	..	..	..	..	..	32,894,538
Municipalities Contributions— Permanent Works—Main Roads .. .. .	128,839	..	..	..	..	..	..	..	..	
Maintenance Works—Main Roads .. .. .	1,889,075	..	..	..	..	..	..	..	..	
	2,017,914	..	..	..	..	..	..	..	..	2,017,914
Commercial Goods Vehicles Act No. 6222 .. .. .	..	8,902,789	..	..	..	..	..	..	..	8,902,789
Public Works and Services Act No. 8049 .. .. .	782,550	..	..	..	..	..	..	..	..	782,550
Fines—Country Roads Act No. 6229 .. .. .	6,986	..	..	..	..	..	..	..	..	6,986
General Receipts .. .. .	536,350	..	..	..	..	..	..	..	..	536,350
State Loan Funds Act No. 6229 .. .. .	..	..	388,000	..	..	..	..	..	..	388,000
Commonwealth Aid Roads Act 1969 .. .. .	..	..	..	23,295,000	2,880,000	14,600,000	650,000	..	..	45,529,127
	37,439,576	8,902,789	388,000	23,295,000	2,880,000	14,600,000	650,000	..	..	88,155,365
<b>PAYMENTS</b>										
Road Expenditure										
Main Roads—										
Construction and Reconstruction .. .. .	8,945,623	..	4,500	2,575,495	21,758	2,172,841	..	13,720,217	..	19,373,349
Maintenance .. .. .	2,823,518	2,780,243	..	..	..	49,371	..	5,653,132	..	..
State Highways—										
Construction and Reconstruction .. .. .	8,017,687	..	383,500	4,963,198	707,099	..	..	14,071,484	..	20,455,043
Maintenance .. .. .	498,328	5,885,231	..	..	..	..	..	6,383,559	..	..
Freeways—										
Construction and Reconstruction .. .. .	1,103	..	..	9,259,170	1,753,019	..	..	11,013,292	..	11,367,650
Maintenance .. .. .	117,043	237,315	..	..	..	..	..	354,358	..	..
Tourists' Roads—										
Construction and Reconstruction .. .. .	1,659,078	..	..	331,764	..	..	..	1,990,842	..	2,664,520
Maintenance .. .. .	673,678	..	..	..	..	..	..	673,678	..	..
Forest Roads—										
Construction and Reconstruction .. .. .	..	..	..	..	..	555,532	..	555,532	..	902,286
Maintenance .. .. .	307,497	..	..	..	..	39,257	..	346,754	..	..
Unclassified Roads—										
Construction and Reconstruction .. .. .	1,839,458	..	..	3,944,373	40,024	8,350,827	..	14,174,682	..	16,967,118
Maintenance .. .. .	286,464	..	..	..	..	2,505,972	..	2,792,436	..	..
Murray River Bridges and Punts .. .. .	68,542	..	..	..	..	..	..	..	..	68,542
Traffic Line Marking .. .. .	412,776	..	..	..	..	..	..	..	..	412,776
Statutory Payments										
Interest and Sinking Fund .. .. .	2,504,127	..	..	..	..	..	..	..	..	3,943,489
Traffic Authority Fund .. .. .	308,682	..	..	..	..	..	..	..	..	940,823
Tourist Fund .. .. .	617,363	..	..	..	..	..	..	..	..	..
Transport Regulation Fund .. .. .	513,317	..	..	..	..	..	..	..	..	..
	3,943,489	..	..	..	..	..	650,000	..	..	..
Planning and Research .. .. .	290,823	..	..	..	..	..	..	..	..	..
Capital Expenditure										
Plant Replacement and Additions .. .. .	1,956,367	..	..	..	..	..	..	..	..	2,555,432
Buildings, Workshops, etc. .. .. .	599,065	..	..	..	..	..	..	..	..	8,426,337
	2,555,432	..	..	..	..	..	..	..	..	..
Management and Operating Expenditure .. .. .	4,921,037	..	..	2,221,000	358,100	926,200	..	..	..	..
	37,361,576	8,902,789	388,000	23,295,000	2,880,000	14,600,000	650,000	..	..	88,077,365
Balance at 30th June 1971 .. .. .	78,000	..	..	..	..	..	..	..	..	78,000

NOTE: Relief to Municipalities granted under Act 6229 Section 32 amounted in 1970/71 to \$25,989,71.

R. G. COOPER,  
Chief Accountant,  
7th December, 1971.

#### AUDITOR-GENERAL'S CERTIFICATE

The accounts of the Country Roads Board for the year ended 30th June, 1971, have been audited. In my opinion the above Statement of Receipts and Payments fairly presents in summary form the transactions during that period.

B. HAMILTON  
Auditor-General  
9th December, 1971

## APPENDIX 7

### COUNTRY ROADS BOARD

LOAN LIABILITY AS AT 30TH JUNE, 1971.

	Main Roads, etc.	Developmental Roads	Total
	\$	\$	\$
<b>Permanent Works</b>			
Main Roads .. .. .	16,711,281.15		16,711,281.15
State Highways .. .. .	16,923,345.21		16,923,345.21
Freeways .. .. .	3,000,000.00		3,000,000.00
Tourists' Roads .. .. .	227,316.44		227,316.44
Forest Roads .. .. .	2,167.89		2,167.89
Developmental Roads .. .. .		12,851,515.09	12,851,515.09
Discount and Expenses .. .. .	718,136.04	578,561.50	1,296,697.54
<b>Total Amount Borrowed</b> .. .. .	<b>37,582,246.73</b>	<b>13,430,076.59</b>	<b>51,012,323.32</b>
<b>Less Redemption of Loans</b>			
Redemption Funds .. .. .	170,438.11	1,292,772.73	1,463,210.84
Main Roads Sinking Fund .. .. .	571,376.76		571,376.76
Developmental Roads Sinking Fund .. .. .		110,166.02	110,166.02
State Loans Repayment Fund .. .. .	3,107,455.71		3,107,455.71
National Debt Sinking Fund .. .. .	6,049,297.15	6,145,103.99	12,194,401.14
Consolidated Fund .. .. .	427.90		427.90
	<b>9,898,995.63</b>	<b>7,548,042.74</b>	<b>17,447,038.37</b>
<b>Loan Liability at 30th June, 1971</b> .. .. .	<b>27,683,251.10</b>	<b>5,882,033.85</b>	<b>33,565,284.95</b>



## APPENDIX 8

WORKS EXECUTED ON BEHALF OF COMMONWEALTH AND STATE GOVERNMENT AUTHORITIES, ETC.,  
FOR THE YEAR ENDED 30TH JUNE, 1971.

(Adjusted to nearest Dollar)

Departments	Description of Works	Expenditure	
		\$	\$
<b>Commonwealth—</b>			
Department of Works ..	Access roads to various Commonwealth establishments.	1,888	1,888
<b>Victoria—</b>			
Forests Commission .. ..	Construction of Car Park at Mt. Donna Buang.	3,511	
Lower Yarra Crossing Authority	Authority's share of costs of acquiring land in connection with Williamstown Road Interchange as part of Lower Yarra Crossing Project.	36,916	
Melbourne and Metropolitan Board of Works .. ..	Roadworks in Healesville Shire, Sherbrooke Shire and Berwick Shire.	97,068	
Ministry of Tourism ..	Development of Rest Areas on State Highways at selected locations throughout the State.	3,310	
Premier's Department ..	Roadworks—Wonderland and Sundial Roads—Stawell Shire	300	
Public Works Department ..	Bituminous sealing at Ararat Gaol and Dookie Agricultural College.	2,695	
Rural Finance and Settlement Commission .. ..	Roads in Commission land settlement projects throughout the State.	80,583	
State Rivers and Water Supply Commission .. ..	Completion of road works in connection with Lake Nillahcootie deviation.	329 Cr.	224,054
State Treasury .. ..	Kings Bridge—land compensation and other sundry expenditure less proceeds of rental of properties acquired in connection with the construction of Kings Bridge.	2,726 Cr.	
” ” .. ..	Grade Separation Projects, etc., charged to Level Crossings Fund (\$136,686) and Railways Department (\$501,172).	637,858	
” ” .. ..	Pedestrian Overpasses charged to State Treasury (\$10,678) and Municipalities (\$10,678).	21,356	
” ” .. ..	Improvements to various roads adjacent to State Forests to facilitate the extraction of timber and charged to the Municipalities Forest Roads Improvement Fund.	37,958	
” ” .. ..	Construction of roads and bridges charged to the Roads (Special Projects) Fund.	7,760,785	
			8,455,231
			8,681,173



## **APPENDIX 9**

### **CHIEF ENGINEER'S REPORT**

Country Roads Board  
Melbourne

THE CHAIRMAN,

I have the honour to submit the Chief Engineer's Report for 1970/71. The report covers those activities within the Chief Engineer's Branch which are considered to be of special technical and general interest.

T. H. RUSSELL,  
Chief Engineer



# BRIDGE SUB-BRANCH

## 1. DESIGN

### USE OF COMPUTER IN BRIDGE DESIGN

- (i) Use of the C.R.B. IBM 1620 computer.

The Board's computer was used for 490 hours of running time during 1970/71 in the design of 80 projects.

- (ii) Development of new computer programmes.

- (a) Bridge substructure design system.

The substructure system was described in the 1968/69 Report. It is a series of programmes which produce crosshead bending moments and shear force envelopes, column stresses and pile loadings for abutments or piers.

Shortly the system will provide for single column piers to supplement the two and three column pier programmes now in use. The expanded facilities of the single column pier programmes will cater for the analysis of piers which are non-symmetrical, with varying cross-sections, and end conditions which may be free, pinned or fixed. The piers need not have crossheads.

A set of programmes for the analysis of three column abutments is substantially complete. The abutments may be unsymmetrical with tapered columns of unequal length.

- (b) Bridge superstructure design system.

The superstructure system is a suite of interrelated programmes designed to assist in the analysis of continuous beam superstructures. The original system, which was described in the 1968/69 Report, was used in the design of the Bell Street Bridge on the Strathmore Freeway.

The original concept has since been revised and expanded. Redevelopment began in the middle of the 1970/71 financial year. The revisions have been made possible by the availability of external computers larger than the Board's IBM 1620. The result will be a system with greatly expanded capabilities, greater flexibility and reduced operating costs.

The expanded system will process five common structural types for both composite and non-composite action. Using the structural data supplied by the designer the system distributes and envelopes the applied loads, groups them together in accordance with the design code requirements and then determines the stresses at points throughout the cross-section. Reports may be obtained on the stage by stage build-up of moments, shears, reactions, stresses and deflections throughout the construction of the bridge and then at working loads. Intended development also includes the determination of capacity under ultimate loads and the automatic selection of prestress force for the particular case of two span prestressed concrete continuous girders. Structures may consist of a maximum of 9 spans and 30 construction stages.

The basic system is expected to be operational during the 1971/72 financial year.

- (iii) Use of computers other than the Board's.

The demand for the structural programme packages described in the 1969/70 Report together with the requirements of the computer systems under development have contributed to an increasing use of external computers.

- (iv) Programmable desk calculator.

A Hewlett Packard 9100B programmable desk calculator with printer attached was installed in December 1970. It has proved to be a popular design tool, with 50 programmes in use.

### BELL STREET BRIDGE, STRATHMORE BY-PASS ROAD

The research programme on this bridge, which was opened to traffic on 14th July 1970, continued during 1970/71 and most aspects of the programme are now completed. However, temperatures are still being recorded.

Results, further to those reported in the 1969/70 Report, are as follows:

- (i) Short-term and long-term tendon load losses.

Initial and short-term load loss measurements, and the analysis of these readings, have been completed. Useful information regarding friction losses and the performance of different types of ducting was obtained from these measurements (see the 1969/70 Report for further detail).

All load cells installed for measurement of the tendon loads failed to operate after grouting of the tendon ducts. Although great care had been taken to waterproof the load cells and electrical system, moisture apparently entered under high pressure during grouting, causing failure of the system. Hence, no long term load losses can be obtained.

(ii) Differential thermal effects in the spine beam.

Automatic recording of the temperature at various positions in the concrete box girder was continued. The maximum temperature recorded in the bridge during this period was 124.5°F., while the minimum recorded temperature was 40.5°F. The maximum temperature difference through the cross-section was 35°F.

Recording of temperature will be continued during 1971/72, each of the sixty-eight thermocouples being read every 2 hours.

(iii) Deflections, settlements and longitudinal variations due to thermal and post-tensioning effects.

A further set of deflection readings was taken during October, 1970, and no significant change from the original deflection profile was observed.

Four potentiometers, one either side of each abutment, were installed in December, 1970. These potentiometers measure the longitudinal movement of the bridge relative to the abutments. Readings from these indicate that the bridge is bending transversely due to transverse temperature differentials.

(iv) Load distribution to various elements of the superstructure.

Results from loading tests to determine the distribution of cantilever loads into the spine beam elements are shown in Figure 1, which also indicates the location of the test load, an 18 ton axle (40.32 kip) with one wheel against the kerb.

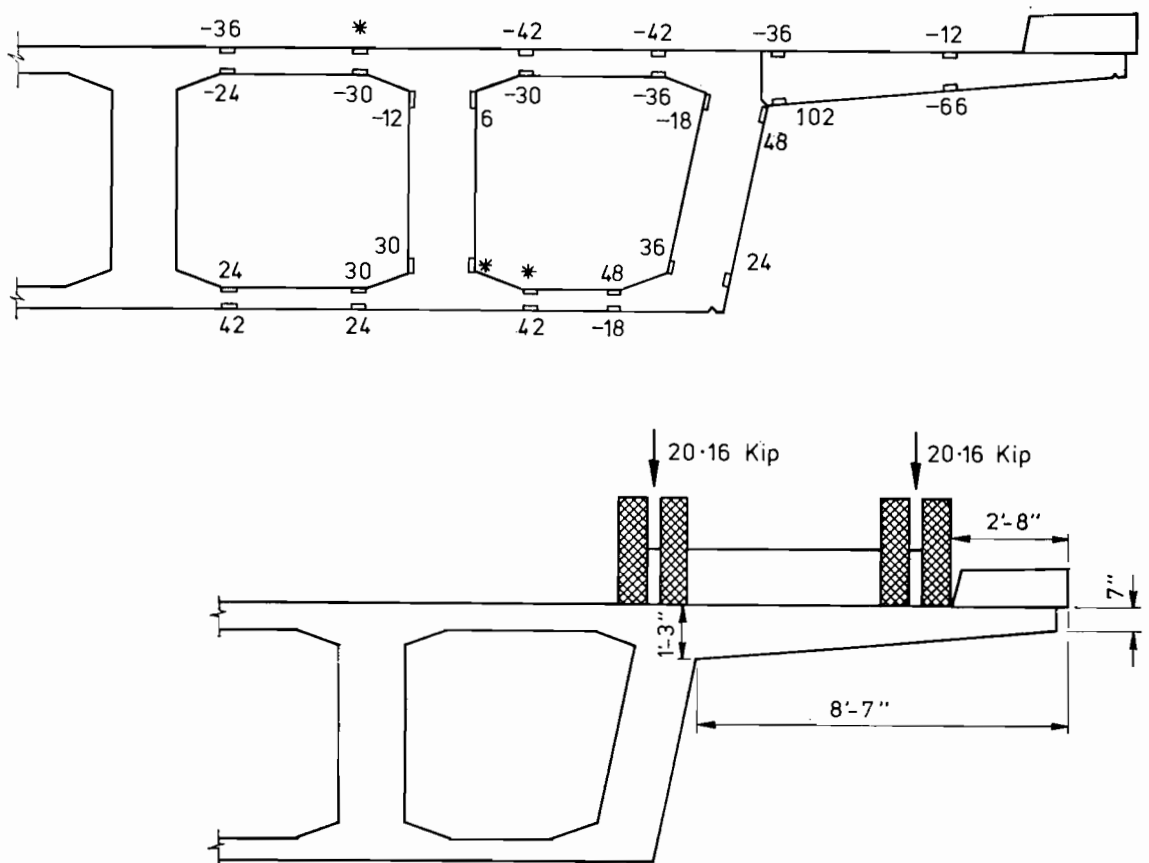

- Notes: 1. "\*"—Gauges not operating.  
 2. Stresses in p.s.i.  
 3. "-" indicates tension.

Figure 1—Bell Street Bridge

Top: Stresses due to transverse distribution of loaded truck axle.

Bottom: Location of loaded axle.

## 2. CONSTRUCTION

### RAIL OVERPASS STRUCTURE AT LYONS, PRINCES HIGHWAY WEST, AT 249 M.

A level crossing with very sharp approach curves at this location was eliminated by constructing a rail overpass structure utilising an Armco corrugated metal pipe 330 ft. long by 22 ft. diameter on a skew of  $65^{\circ} 25'$  (Plate 1).



*Plate 1—View of Lyons grade separation structure (before completion of the roadworks) showing the sharp approach curves to the rail level crossing.*

The railway track is placed in the invert of the culvert which is approximately at natural surface level, and the road embankment over the pipe provides a minimum cover of 3 ft. at the crown.

The works were planned carefully to minimise interruptions to rail traffic. Eighteen hours was the longest period of closure of the line which occurred during placing of the complete culvert invert and reinstatement of the track with new sleepers and heavier rails.

After preliminary drainage works the sequence of operations was:

- (a) New track pre-assembled in 110 ft. sections near the site, and culvert invert plates pre-assembled in one 330 ft. long section alongside the existing track.
- (b) Pipe bedding material and railway ballast material stacked nearby.
- (c) After the last train, rail sections disconnected and towed clear. Base prepared and pipe bedding material placed and compacted (Plate 2).

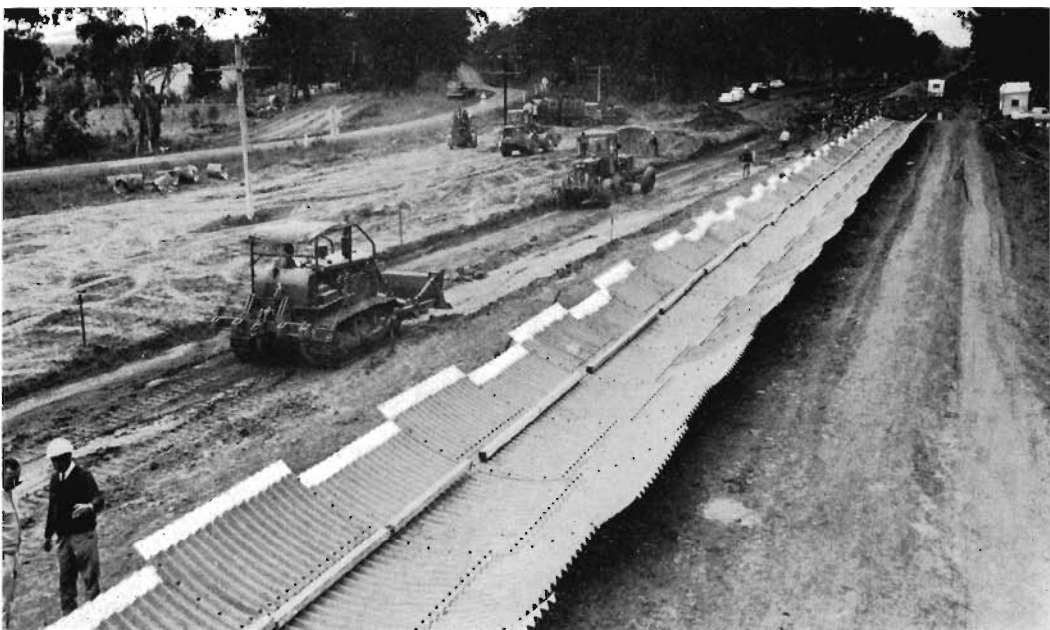

*Plate 2—Lyons grade separation structure: preparation of base and pipe bedding.*



- (d) Assembled culvert invert plates 330 ft. long, towed sideways into position. Supporting haunch filling outside the culvert and selected filling inside the culvert for temporary bedding of the track, placed and compacted.
- (e) Pre-assembled rail-sleeper sets towed into position and connections made ready for the next train.
- (f) Between trains, full multiplate culvert ring placed and bolted using motor truck mounted scaffolds inside and a hydraulic crane outside (Plates 3 and 4).
- (g) Road formation over the pipe constructed following the tightening of all bolts, and railway track inside the culvert reset and ballasted.

One hundred and forty-five tons of  $\frac{1}{4}$  in. thick multiplate was used in the pipe, which took 4 weeks to assemble.



Plate 3—Lyons grade separation structure: multiplate ring partly completed.



Plate 4—Lyons grade separation structure: placing and bolting of multiplate ring, using a crane and motor truck mounted scaffolds.

RECENT DEVELOPMENTS IN BOARD'S PILING PRACTICE

(a) Steel H piles.

Steel H piles have recently been used in the foundations of the following structures—

Blackshaws Road Underpass	Lower Yarra Freeway
Stud Road Overpass	Mulgrave Freeway
Power Road Overpass	Mulgrave Freeway
Bridges over Dandenong Creek	Mulgrave Freeway
Bridge over Barwon River, Batesford	Midland Highway

Their use has shown steel H piles to be an economical alternative in certain circumstances to other driven types such as precast concrete and steel shell piles. In addition, the ability of steel H piles to withstand hard driving and to penetrate hard layers and boulder material is noteworthy.

Because of their small displacement and relative ease of driving, H piles can often be driven to the desired penetration with less recourse to jetting or preboring than may be required for the other types. Additionally, as the section is relatively light, inertia losses are small and the resulting high degree of driving efficiency assists in providing increased penetration capability.

As with steel shell piles, H piles can be readily increased in length by splicing and should therefore be considered where there is uncertainty regarding the penetration depth. Also as with steel shell piles, H piles can be handled and pitched with relative ease.

As H piles tend to penetrate further for a given load capacity than do other types of displacement pile, the increased footage per pile could place the H pile at a cost disadvantage. However, if the extra penetration capacity permits reaching bed-rock or a suitable hard layer, the design can allow for higher working loads and a reduction in the number of piles required. In these cases H piles can offer an economical solution, at the same time providing a settlement-free foundation.

A disadvantage is the need to provide for corrosion protection. Three types of protection are suitable, viz., cathodic, coating systems, and concrete encasement. Steel piles driven into undisturbed soils are generally not affected by corrosion because of the oxygen deficiency in such soils. For this reason protection is usually confined to the upper part of the pile. The methods of protection employed by the Board to date have been the use of a coating system or concrete encasement. The coating system used has been either a bituminous enamel or a coal tar epoxy, the latter type of coating being able to endure hard driving through abrasive material without damage to the coating.

(b) Bored, cast *in situ*, concrete piles.

With the advent of improved drilling equipment and techniques, the bored pile is being used increasingly in foundation engineering.

Recently, bored piles have been adopted for several bridges being constructed by the Board. These include—

Western Interchange	Bacchus Marsh section of the Western Freeway
Gladstone Road Overpass	Mulgrave Freeway
Wellington Road Overpass	Mulgrave Freeway
Springvale Road Overpass	Mulgrave Freeway

Because of handling and driving difficulties, displacement piles are limited to sizes significantly less than can be obtained with bored piles. In addition, bored piles are often under-reamed at the toe providing an enlarged base and thus an increase in end bearing capacity.

In addition to providing a means of upgrading pile capacity, under-reaming can be used to decrease end bearing pressures, thus enabling the adoption of shorter piles than would be possible with driven displacement types.

Typical dimensions adopted are a shaft diameter of 1 ft. 9 in. increased at the base to 3 ft. 6 in.

Provided ground conditions are such that no serious problems are encountered with ground water or running material, bored piles can offer an economical foundation compared with driven piles, due to the possible reduction both in number of piles and in footage per pile.

# MECHANICAL SUB-BRANCH

## DESIGN AND DEVELOPMENT

Design, development and construction work has been completed or is in progress as follows:

(a) Pavement striping machines.

The prototype pavement striping machine (described in the 1969/70 Report), which was placed in operation during 1970/71, has proved very successful. The construction of four more machines has been approved.

(b) Road rollers.

The Board and a Melbourne firm co-operated in the successful conversion of a three-wheel steel-drum 10-12 ton road roller from mechanical to hydrostatic drive. The hydrostatic transmission provides stepless gear changes and engine braking, and increases the maximum rolling speed from 5 m.p.h. to 6 m.p.h. It is expected that the maintenance costs of the converted machines will be appreciably lower than of rollers with mechanical transmissions.

The roller is one of thirteen which, having sound frames and rolls but requiring complete engine and transmission replacements, will be converted. The cost of conversion is considerably lower than the price of new rollers.

(c) Electrically heated bitumen storage tanks.

The installation of a pair of electrically heated 8,000 gallon capacity bitumen storage tanks at Ballarat is almost completed. The tanks, although generally similar to those erected previously at Horsham, Hamilton and Benalla (described in the 1964/65 Report), are fitted with a new electric indicating and alarm system which will provide a more reliable diagnosis of electrical faults such as burnt out heating elements or faulty thermostats.

(d) Overheight vehicle sensing device.

The Montague Street, South Melbourne, rail over road bridge has been hit a number of times by vehicles with loads higher than the clearance of the underside of the bridge above the roadway. It is proposed to install, at the several approaches to the bridge, a system of devices which will warn drivers if their loads are too high.

The basis of the system is a device which emits a narrow infra-red beam. Prototype tests indicate that the device will be effective in the heaviest rain that is likely to occur and in all but the most severe fog conditions. The latter will probably bring traffic to a standstill in any case. If the system proves satisfactory, its use may be extended to protect other low clearance bridges.

(e) Vehicle weight sensing condenser.

Assistance has been provided to the Australian Road Research Board in the development and evaluation of vehicle weight sensing condensers. The condensers are intended for the determination of axle loads of vehicles on roads.

The condensers are plates constructed by laminating successive layers of adhesive-coated sheets of metal and rubber. The plates are enclosed in protective envelopes and these are attached to road surfaces. The capacitance of the condensers changes as vehicle wheels press the rubber layers into the cavities of the perforated metal layers. The change in capacitance is a function of the weight, which can thus be measured electrically and recorded during any desired time interval.

As a considerable number of alternative methods of construction of the condensers is possible, development is continuing. It is hoped that a satisfactory combination of materials and methods of assembly will be established in the near future.

In conjunction with the work on the condensers, a small machine has been developed, and is under construction, for the testing of small sample plates by providing the necessary impulse rates and forces for their evaluation in the laboratory. The use of the machine will reduce the need for making up full-scale plates and testing them on road surfaces.

(f) Sand spreader.

The Board is providing assistance to a local company in the development of a sand spreader for use on icy roads in mountain areas. The spreader is also envisaged as being suitable for use in other applications, e.g. covering spillages of certain materials, and in spreading an even layer of sand on sand seal bituminous work.

The device is based on a rotating spinner and a chain conveyor fed from a hopper. It is designed to fit on a short wheel base vehicle, and to be as light as possible so as to permit the maximum load of sand and so as not to affect the stability of the vehicle. The spreader is controlled from the cabin of the vehicle, and will spread sand over a nominal width of 14 ft. It will be ready for test in July, 1971.

## NEW TYPES OF PLANT

The following items of major plant and machinery not previously owned by the Board were acquired:

(a) Crawler tractors.

- (i) Fiat, model AD14, torque converter power-shift unit powered by a 6-cylinder 140 h.p. diesel engine. The tractor is equipped with a hydraulically operated angle dozer blade and a hydraulically operated swivel tyne ripper.
- (ii) Caterpillar, model D4D, torque converter power-shift unit powered by a 4-cylinder 65 h.p. diesel engine. This tractor is equipped with a hydraulically operated angle dozer blade.

(b) Pneumatic tyred tractors.

- (i) John Deere, model 4020, towing tractor powered by a 6 cylinder 106 h.p. diesel engine through an 8 speed conventional transmission.
- (ii) David Brown, model 780, unit powered by a 3 cylinder 46 h.p. diesel engine through a 12 speed conventional transmission. This tractor is fitted with a 10 cu. ft. bucket capacity Robot front-end loader, and is used for patrol maintenance work.
- (iii) Chamberlain, Mark 3, industrial tractor powered by a 4 cylinder 64 h.p. diesel engine. This unit is fitted with a Chamberlain, model F1000, front-end loader and a rear mounted Holman, model TA13, compressor. It is used particularly on bridge construction jobs, where air-operated tools can be driven from the compressor.

(c) Hydraulic excavator.

Poclair, model LY80, pneumatic tyred unit powered by a 6 cylinder air cooled 72 h.p. diesel engine. The unit is fitted with a face shovel attachment with a  $\frac{3}{8}$  cu. yd. bucket and is used in the Board's Stawell quarry.

(d) Compressor.

Armstrong-Holland Jaeger rotary vane type compressor, powered by a Perkins, model 6-354, 6 cylinder 78 h.p. diesel engine. The free air output at 100 p.s.i. is 260 cu. ft. per minute. The compressor is mounted on a single axle trailer.

(e) Crane.

Conquip, model CC8-4/2, 8 ton mobile crane mounted on a Chamberlain, Mark 3, industrial pneumatic tyred tractor powered by a 4 cylinder 64 h.p. diesel engine. The crane is used for depot work.

(f) Self-propelled, multi-wheel roller.

Pacific Ace, model 80TC, pneumatic tyred, self-propelled multi-wheel roller powered by a Perkins, model 6-354, 6 cylinder 101 h.p. diesel engine through a torque converter and power-shift transmission. The maximum ballasted weight is 83,500 lb., providing tyre loads of 11,930 lb. on each of seven wheels. Ballasting is accomplished with water and twenty 1,050 lb. removable steel billets. An air operated hoist is fitted for handling the billets.

(g) Drawn vibrating roller.

Pacific, model V12D, towed type smooth drum vibrating roller. The vibrator is powered by a Deutz, model FEL912, 3 cylinder air cooled 38 h.p. diesel engine. The width of the roller is 78 in. and its weight is 11,800 lb.

(h) Water tanker.

Highgate, 3500 gallon capacity, aluminium semi-trailer water tanker coupled to a Dodge, model AT4/760, prime mover, powered by a V8 cylinder, 202 h.p. petrol engine. The tanker is fitted with a constant head device. Spraybar valves for 8 feet and 10 feet and 12 feet wide spraying are operated by air pressure and are controlled from the prime mover cab.

(i) Trucks.

- (i) Dodge, model D2F-848, truck chassis and cab powered by a V8 cylinder, 202 h.p. petrol engine to which a George tray body of 15 ft. deck length is fitted.
- (ii) Bedford, model KH, tandem drive truck chassis and cab powered by a 6 cylinder Bedford 143 h.p. diesel engine through a Fuller 10 speed conventional transmission. This unit is fitted with an Evans tray body of 24 ft. deck length.

## PLANT MAINTENANCE

In 1970/71 there were substantial increases in the cost of spare parts and materials and, particularly, of labour employed by the Board on plant maintenance and associated tasks.

The shortage of suitably skilled and experienced personnel continued, but there was a slight reduction in the number of apprentices who left after completion of their training. In spite of the shortage of suitable labour, adequate plant was made available for field work.

## PLANNING SUB-BRANCH

### 1. ADVANCE PLANNING

#### AUSTRALIAN ROADS SURVEY 1971/72

A survey of the Australian roads system is to be conducted in 1971/72 jointly by the National Association of Australian State Road Authorities (N.A.A.S.R.A.) and the Commonwealth Bureau of Roads, to assess the requirements of the system during the period 1st July, 1974, to 30th June, 1979. The survey will provide data on which the Commonwealth Government may base its decisions regarding the form and content of the 1974 Commonwealth Aid Roads Act.

The Board has commenced the collection of road inventory information relating to the Board's classified road system, and the production of a set of standardised road maps covering the State of Victoria. These preliminary activities, details of which are set out below, are expected to reduce the amount of work for regional Divisions and Municipalities in connection with the survey.

(a) Collection of road inventory information.

To standardise the collection of information on the physical condition of the classified roads system, inspections are being made by a two-man team operating a road inventory vehicle (Plates 5, and 6). The two men alternate in driving the vehicle and observing.

The equipment provided in the vehicle enables the following information to be collected during a single journey along a road:

- (i) length, radius and superelevation of horizontal curves;
- (ii) radius of vertical curves;
- (iii) length and slope of gradients;
- (iv) cross section data;



Plate 5—Road inventory vehicle.

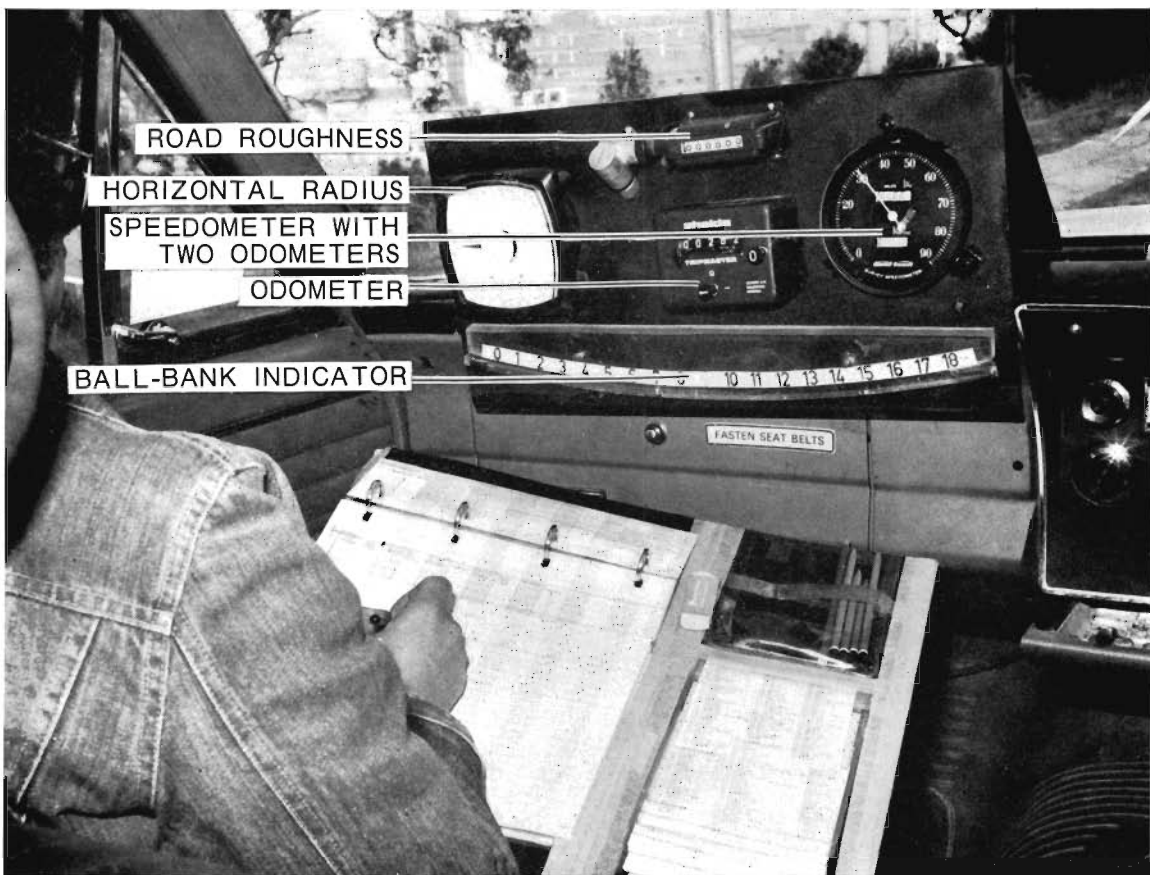

Plate 6—Road inventory vehicle—instrument panel and recording position.

- (v) general data (e.g. land use, terrain);
- (vi) assessments of pavement surface and structural condition;
- (vii) location of features such as bridges, level crossings, mile posts, etc.

The equipment which is used to collect the bulk of the information consists of:

- (i) a ball-bank indicator for curve superelevation measurement;
- (ii) a manometer for measuring the slope of gradients;
- (iii) a device to measure horizontal curve radii, designed and built by the Materials Research Division, operated from the steering mechanism of the vehicle (Plate 7);

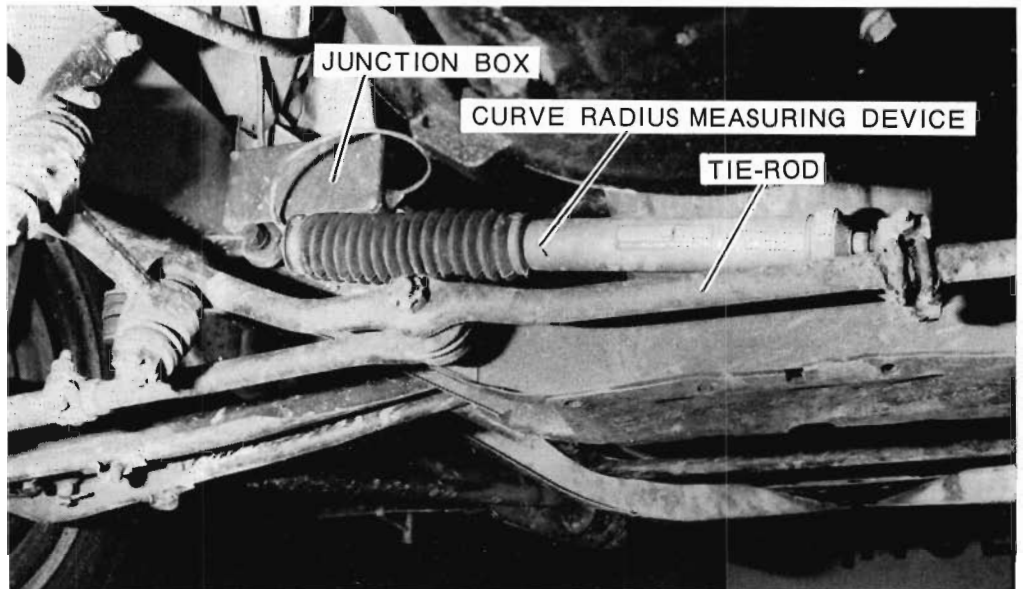

Plate 7—Road inventory vehicle—attachment of the radius measuring device to the steering linkage.

- (iv) a sighting device for measuring vertical curve radii;
- (v) a reversible odometer measuring to hundredths of a mile;
- (vi) a survey speedometer;
- (vii) a measuring wheel and tapes for measuring widths and other dimensions;
- (viii) N.A.A.S.R.A. Roughness Meter;
- (ix) safety devices such as warning signs and a flashing light.

The inventory team had measured 2,000 miles of the classified road system by 30th June, 1971, at an average rate of about 200 miles per week which is expected to be maintained during the remainder of the study. The inventory data will be processed by computer and assessed according to rules formulated for identifying deficiencies. The print-out of deficiencies and the design standards for the solution to each deficiency will be sent to the appropriate regional Division or Municipal Engineer for consideration in the formulation of improvement projects.

(b) Standardized maps.

Planning for the Victorian part of the Australian Roads Survey 1971/72 indicated the need for a set of consistent maps showing all roads in the State. The Board has commenced the production of a series of simple line drawing maps covering the whole State and showing only roads, railways and administrative boundaries.

The maps are based on the Commonwealth Topographic Maps 1 : 250,000 series. One-sixth of each sheet of this series forms a road inventory map at 1 : 100,000. The road inventory maps cover exactly the same area as the maps of the 1 : 100,000 Commonwealth Topographic series (which is not yet complete as at 30th June, 1971) but are on a different projection. The roads and railways shown on the 1 : 250,000 maps have been traced and to these data has been added other road information from various sources. Towns are shown as insets at a scale of 1 : 25,000. The work of drawing the maps should be completed by September, 1971.

It is planned that, during the course of the Australian Roads Survey 1971/72, the maps will be used to locate and identify every trafficked road in Victoria and to serve as a basis for recording various parts of the survey data. It is expected that during the survey, considerable amendments to the maps will be needed, and these will be made after completion of the survey. After the survey the maps will be kept up to date and made available for use by municipalities as required.



## 2. FREEWAY PLANNING AND TRANSPORTATION STUDIES

### PROVINCIAL URBAN TRANSPORTATION STUDIES

The 1969/70 Report referred briefly to the Board being authorized to carry out transportation studies for the provincial cities of Ballarat, Bendigo and Geelong. The studies are proceeding and an outline of the objectives, procedures and results to date is set out below.

For each city the studies encompass all likely urban development until 1991. The objectives of the studies are as follows:

- (i) to ensure that proper and adequate provision is made for the transportation of people and goods in the period 1970 to 1991;
- (ii) to develop, within the framework of the likely economic development of the areas and the development of other transport modes, realistic long-range road transport plans and parking forecasts to guide the expenditure of public funds;
- (iii) to enable the effects of planning, technical or community changes in the future to be investigated.

For each of the cities, the Board has established a Study Committee which is responsible to the Board for the supervision and control of the study. The Committees consist of representatives of the C.R.B., the Transport Regulation Board, and local municipalities or the local planning authority. Meetings of each Committee are attended by an officer of the Ministry of Transport. During 1970/71 eleven committee meetings were held for Ballarat, eight for Bendigo and eleven for Geelong.

The Committees have finalised agreements with three firms of consulting engineers which are recognised in this field, to carry out the studies. By the agreements, the Ballarat study is to be completed by 10th November, 1971, the Bendigo study by 2nd November, 1971, and the Geelong study by 24th March, 1972.

Six basic surveys were conducted in connection with each study, as follows:

- (i) a sample home interview survey was conducted to provide data on households, persons and origin/destination patterns for weekday travel. In Ballarat 1,459 successful interviews were completed, in Bendigo 1,774, and in Geelong 4,117;
- (ii) consultant economists acting for the main consultants conducted employment surveys which, with other data, enabled an assessment of the economic structure of each city and its growth prospects. To allow for possible accelerated growth rates in Ballarat and Bendigo, two rates of growth were specified, i.e. normal and accelerated. Population growth levels were also estimated, as follows:

		Ballarat*	Bendigo	Geelong
For normal growth:	1971	67,250	49,500	122,500
	1981	75,600	53,400	145,500
	1991	83,000	58,500	187,800
For accelerated growth:	1981	88,500	56,400	—
	1991	111,000	67,700	—

\*The population estimates for Ballarat are for an area somewhat larger than the study area.

- (iii) a commercial vehicle survey to determine the volume and pattern of trips of commercial vehicles, by classes;
- (iv) an external cordon survey. Where the most important roads crossed the boundaries of the study areas, roadside interviews were conducted to assess the amount of travel into, away from and through the areas;
- (v) parking surveys, consisting of inventories of parking space, provision for defined central areas and for two suburban centres for each study. Parking accumulation patterns were also determined. In Geelong a special survey of industrial parking was made to assist planning ordinance specifications and parking at three inner rail stations was studied;
- (vi) speed and traffic delay studies of conventional type, carried out in selected areas or along selected roads, to determine the standards of operation of the existing road traffic system.

Surveys were also made regarding recreational travel at weekends and an inventory of land use was made. In connection with the Ballarat and Bendigo studies, local organizations participated in questionnaire surveys regarding "Community Goals and Objectives".

As at 30th June, 1971, the final report for the Ballarat study is in preparation: a basic data report has been drafted and a report on population and employment forecasts has been completed for the Bendigo study; and, for the Geelong study, a draft report on the surveys and travel characteristics and a report on population and employment forecasts have been completed.

## FREEWAY PLANNING

During 1970/71 the Board approved the following freeway projects which had been developed to the preliminary layout stage:

Hume Freeway—from Bell Street to north of Craigieburn—13 miles (Figure 2)

Calder Freeway—by-pass of Diggers Rest—2½ miles

Latrobe Valley Freeway—by-pass of Drouin and Warragul—total of 11.05 miles (Figure 3)

Healesville Freeway—Lilydale section—6 miles (Figure 4).

## ROAD NETWORK PLANNING

The Board approved two road network proposals based on regional considerations, viz.,

(i) Hastings Region Road Network.

The likely land use in the region and the consequent travel desire pattern were studied, and an assessment was made of the road network required to provide the travel demand at an acceptable level of service. One of the conclusions approved as a guide to future planning is that in addition to the Mornington Peninsula Freeway, a freeway will be required on the corridor joining the Dandenong-Berwick area to the Hastings area. Several other east-west routes are also proposed, for development as divided roads.

(ii) Metropolitan Freeway Network—Freeway F35

(Extension of Scoresby Freeway southerly from Dandenong).

The 1985 Freeway Network recommended by the Metropolitan Transportation Committee and adopted by the State Government did not contain a section of the Mornington Peninsula Freeway from Dingley Freeway southwards which had been earlier adopted by the Board. Following investigation of the routes in the Wells Road corridor the Board approved a network including F35, an extension of the Scoresby Freeway southerly from Dandenong to Frankston. F35, together with the development of Wells Road to freeway standard as F6, will conform to the Metropolitan Transportation Committee's network and will serve the travel demand between the Melbourne metropolitan area and the Mornington Peninsula.

## ROUTE SELECTION DEVELOPMENTS

Following discussions between staff of the Board and of the University of Melbourne regarding route optimisation techniques, a test on optimal route location and profile studies was done at the University during 1970/71, using the University's computer facilities. The test showed promise for further development of the techniques.

The optimisation system uses a dynamic programming algorithm to generate and select alignments and profiles which are optimal in terms of specified construction and maintenance and user costs, and are feasible with regard to constraints on grades, curvatures and locations. The advantage of the system is that in areas where road user costs and highway costs can be quantified (this applies particularly to rural areas where topography is a predominant factor) a thorough study of many alignment and profile alternatives can be readily undertaken.

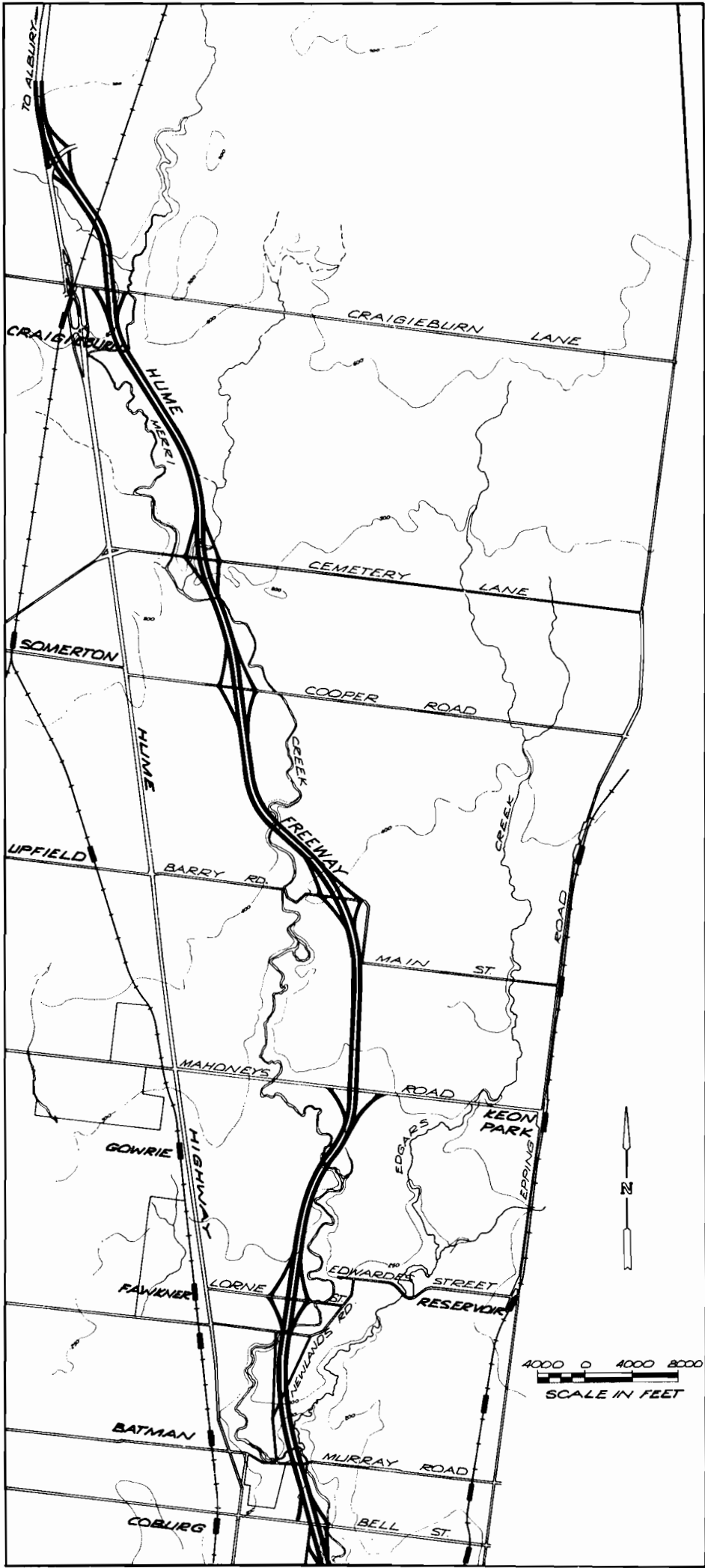

Figure 2—Proposed Bell Street-Craigieburn Section of the Hume Freeway.

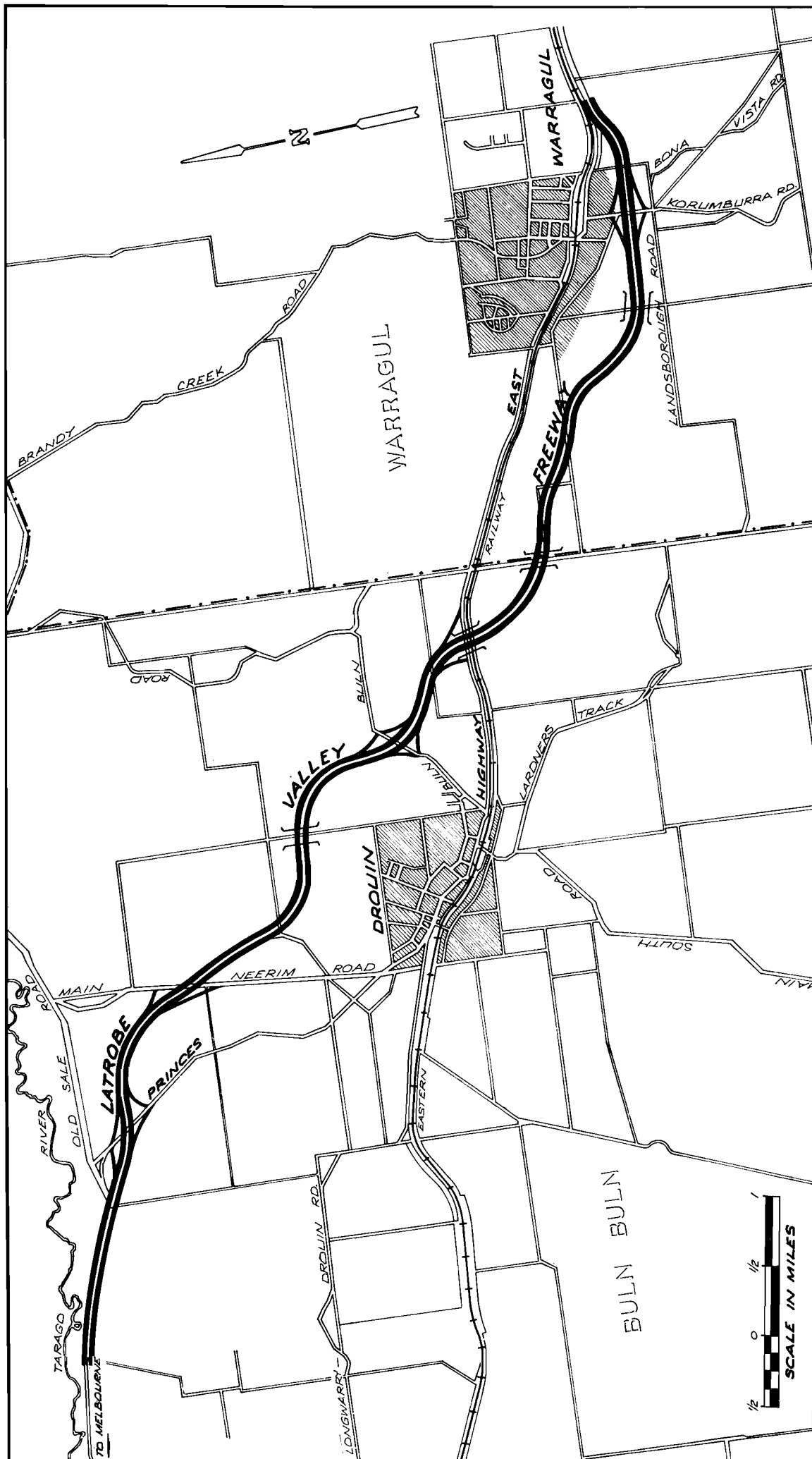

Figure 3—Proposed Drouin-Warragul Section of the Latrobe Valley Freeway.

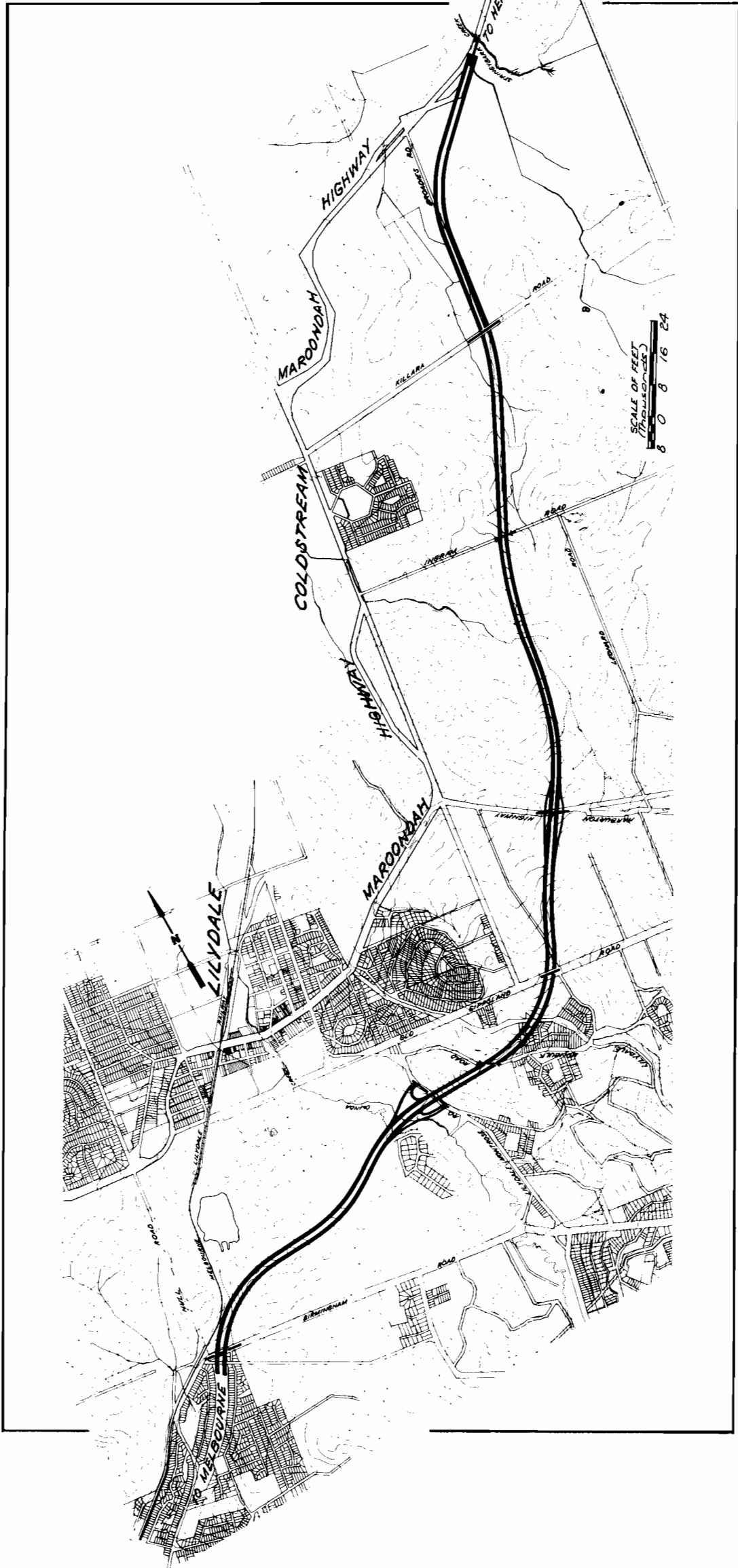

Figure 4—Lilydale Section of the Proposed Healesville Freeway.

# ROAD DESIGN SUB-BRANCH

## 1. ENGINEERING PLANS AND SURVEY

### ENGINEERING SURVEYS

Head office engineering survey parties carried out the following surveys during 1970/71:

Freeways	75 miles
State highways—general	18 miles
—reconstruction	4 miles
Other roads—general	17 miles
—reconstruction	7 miles
Ground control for photogrammetry	195 miles
	<hr/>
	316 miles
	<hr/>

Consultants completed 22 miles of freeway surveys, consisting of 11 miles of photo-control surveys and 11 miles of preliminary and reference traverses.

The use of the Wild Distomat D1 10 electronic distance measuring unit (purchased in 1969/70) has resulted in a saving of survey time with added reliability in measuring. It has been used mainly on photo-control surveys, preliminary traversing of freeway centrelines and connecting feature surveys to freeway project controls.

Bench marks were established over 120 miles of State highway for subsequent levelling referred to the State datum by the Department of Crown Lands and Survey.

### PLANS FOR ROAD CONSTRUCTION

The extent of final construction plans completed in, or under the direction of, the Plans and Survey Division during 1970/71 was as follows:

(a) Route miles

Freeways	17
Other divided roads	5
Undivided	57
	<hr/>
	79
	<hr/>

(b) Estimated cost of roadworks

Freeways	\$10,103,000
Other divided roads	\$1,315,000
Undivided roads	\$2,542,000
Grade separations }	
Other projects }	\$1,159,000
	<hr/>
	\$15,119,000
	<hr/>

Consultants completed the designs for five major roadwork projects as follows:

Mulgrave Freeway, Section B: 4.6 miles between Springvale Road and Stud Road, estimated cost \$3,995,000;

Nepean Highway: 1.3 miles between Lower Dandenong Road to White Street, reconstruction from four lanes to six lanes, estimated cost \$400,000;

Beaconsfield-Emerald Road: 5.05 miles, estimated cost \$395,000;

Eumemmerring Freeway: 2.04 miles between the Princes Highway East and the South Gippsland Highway, estimated cost \$2,184,000;

Acheron Way: 2.0 miles, estimated cost \$150,000.

## CONTRACT SPECIFICATIONS

Specifications advertised during 1970/71 were as follows:

	Number	Value
Contracts for materials and incidental construction works	113	\$5,000,000
Contracts for road construction projects	21	\$9,400,000

## PHOTOGRAMMETRY

Flying for aerial photography was again co-ordinated and controlled by the Department of Crown Lands and Survey. The photography was carried out by a company under contract, using three aircraft during the main flying season from October to March and one single engine aircraft during the remainder of the year. RC8 film cameras and an RC7 plate camera were the main cameras used.

Ground surveys for photogrammetric control were carried out, generally after liaison with the Geodetic Branch of the Department of Crown Lands and Survey. A project control survey network over each area to be mapped, tied to the State geodetic system, was first carried out. This was followed by a photo-control survey, which was used for the accurate establishment of the photogrammetric models and the preparation of the final mapping project.

Project mapping for six location investigations and detailed design was prepared by the Project Mapping Section of the Department of Crown Lands and Survey, at various scales and contour intervals.

Negotiations were finalised with mapping consultants for the preparation of three large scale mapping projects. At present, three consultants are involved with this work in conformity with an Agreement and Specification for Photogrammetric Mapping and Survey Work which has been prepared by the Board for this work.

Using a machine on loan from the Department of National Mapping, the Department of Crown Lands and Survey has produced an "orthophoto" map, with contours added by the Board's plotting machine, of the Cabbage Tree deviation of the Princes Highway East. Orthophotography is a recent development of normal photogrammetric mapping in which a photo-mosaic (corrected for scale, co-ordinated position, and image displacement) is produced by automatic incremental adjustment of the stereoscopic models.

## COMPUTER USAGE

As a further supplement to the use of the Board's IBM 1620 computer, a second Hewlett Packard 9100B programmable calculator was obtained for use by design staff. Further programme development was carried out and a Manual of Programmes was issued. There are now forty-five Road Design programmes available.

A series of computer programmes has been written to produce terrain input for earthworks programmes, using an X, Y digitising table with paper tape punched output. The cross-section data is produced using topographical plans as base maps, with the operator visually traversing the cross-section line. Future developments will enable this data to be obtained direct from aerial photographs.

## 2. RIGHT OF WAY

### PLANS

#### (a) Right of Way Plans.

Right of way plans showing in pictorial form land tenure, leased land, surplus land, access details, sub-divisional development and other matters were compiled for:

- the Lower Yarra Freeway;
- the Western Freeway (Bacchus Marsh section);
- the Western Freeway (Gordon section);
- the Heidelberg-Eltham Main Road.

Also, existing right of way plans were revised as required.



(b) Access Authorisation Plans.

Plans were prepared to enable the Board to authorise the necessary points of access to certain freeways. Small scale plans were also prepared to assist the publicising, by advertisement, of the regulations controlling the use of the freeways. The projects involved were:

- the Tullamarine Freeway;
- the Western Freeway (Gordon section);
- the Western Freeway (Bacchus Marsh section);
- the Calder Freeway (Elphinstone section);
- the Lower Yarra Freeway.

(c) Tenure Plans.

For 17 projects, tenure plans were compiled to assist Divisions in assessing the effect of projects on land usage and ownership. The plans were also used to determine any alternative access proposals.

(d) Highway Record Survey Plans.

Highway record survey plans were completed for:	
the Princes Highway East, Section 4	60 miles
the Princes Highway West, Sections 3, 4 and 5	153 miles
the South Gippsland Highway (revision)	10 miles
Strip aerial mosaic was prepared for:	
the Ocean Road, Torquay-Peterborough	130 miles

#### ODOMETER SURVEYS

Odometer surveys were carried out on:

the Mansfield-Woods Point Road	56 miles
Main and forest roads in Otway Shire	180 miles

#### TOWN PLANNING

Two sets of coloured plans were prepared for each of thirteen principal statutory planning schemes which were on public exhibition during the year. Detailed examination of these new schemes, and amendments to existing approved schemes, were made to ensure that the Board's interests were not affected.

### 3. TITLE SURVEY AND PRINTING

#### DRAFTING

A total of 400 survey plans, drawn from control surveys, acquisition surveys, subdivision surveys, and other sources of survey information, were completed during the year.

Also, a total of 1,037 Gazette plans were prepared for Approving Orders in Council, Fixing New Alignments and Declarations. Declarations were gazetted for seven miles of new freeways and 137 miles of new forest roads.

Approximately 2,100 document diagrams were drawn for 1,403 cases of land acquisition and sales of old road and surplus areas.

The new 1 : 500,000 C.R.B. map of Victoria was produced in eight colours, with variations in blue, green and purple obtained by screening. The map was printed in four sheets by the Government Printing Office and distributed throughout the Board and to all Government departments and municipalities.

For the Advance Planning Division, forty Road Inventory maps (of a total of 120) as 1 : 100,000 were produced, and Urban Arterial Road maps as follows:

Melbourne: 4 sheets at 1 : 100,000.

Ballarat, Bendigo, Geelong: 1 sheet each at 1 : 25,000.

A map titled Guide to Cross-City Routes was produced for the Traffic Section, four feature maps for the C.R.B. Newsletter were compiled, and the map of the Board's road system, showing the types of road construction, was revised and reprinted.

The Plan Room staff designed and prepared an Exhibition of Bridge and Freeway Surveys for the 14th Survey Congress of the Institution of Surveyors, Australia, in Hobart, February, 1971.

## PRINTING

The machine runs for offset printing totalled 5,403,000, and the photo-direct camera produced some 16,000 plates. These activities increased considerably from the 1969/70 level.

A large collating machine and a fast plan printing machine were installed, increasing the efficiency of production.

Major printing jobs included:

- Roadside Development Manual
- Laboratory Manual, Parts 1 and 2
- Science in Road Development (brochure)
- Wonnangatta-Buffalo River Road (brochure)
- Industrial Manual (amendments)
- Typing Manual (amendments)
- Board's Road System, showing Types of Construction
- The Road Builders (brochure)
- Country Roads Board Financial Facts

## SURVEYS

With the advent of survey integration, and due to the increasing size and complexity of most new projects, the system of project control surveys has been further developed, to the stage where every survey for projects can be based on a common azimuth datum and grid co-ordinates.

The Australian Map Grid (A.M.G.) has been officially adopted by the Surveyor-General for integration in Victoria. The Department of Crown Lands and Survey geodetically adjusts the Board's surveys to provide accurate grid co-ordinates for a network of permanent survey marks carefully located about the project. All subsequent surveys (photo-control, engineering and land acquisition) are tied to these marks, so that any survey point is recoverable. The system is proving very satisfactory, and will eliminate wasteful duplication.

Project control surveys completed during the year covered a total of 58 route miles and also involved electronic measurements of distance by use of the Geodimeter over a total of 238 miles (Plates 8 and 9). At the end of the year project control surveys were in hand for a further 45 route miles on freeways.

A total of 214 cadastral or land acquisition surveys, giving rise to 329 survey plans, was completed. In the course of all the above surveys, 317,300 lines were computer processed.

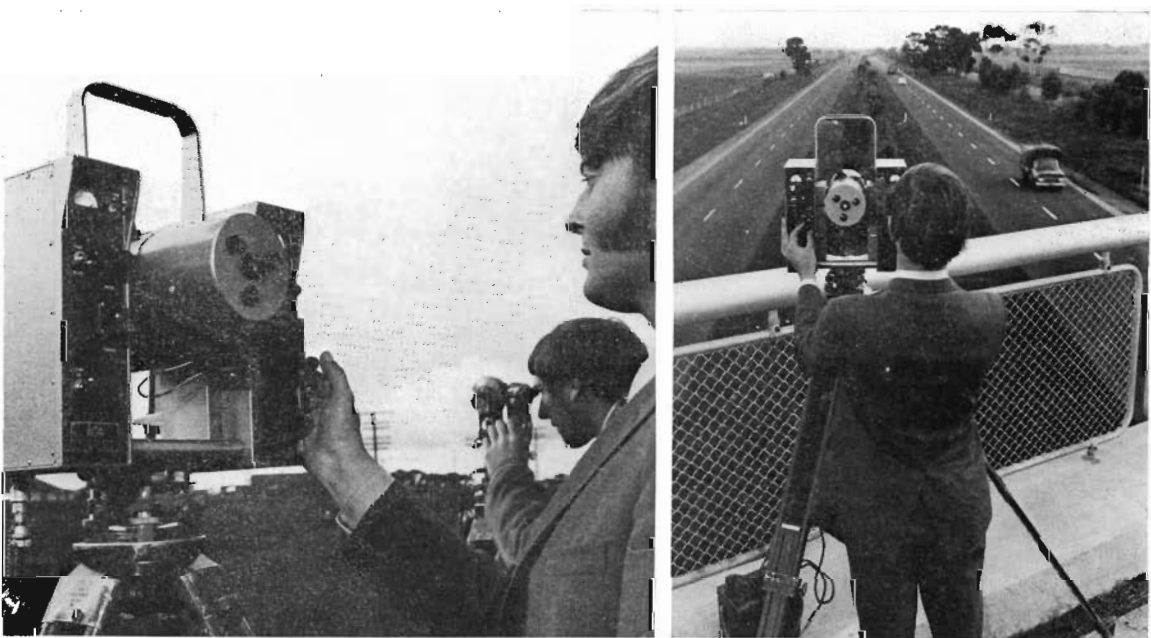

Plates 8 and 9—Use of the Board's Geodimeter 6A electronic distance measuring equipment during a project control survey.

## 4. TRAFFIC ENGINEERING

### TRAFFIC OPERATIONS

Investigations were completed and alternative schemes were prepared for layouts for road signs and road marking, sign post schedules (specifications of location, type, height, etc.) and manufacturing drawings for signs for various types of roads and intersections.

An innovation for the Board was the introduction of the use of frangible supports (both timber and aluminium) for roadside mounted signs (Plate 10 depicts frangible timber posts). The property of frangibility is a safety measure in the event of a support being struck by a vehicle, in that the force of collision is reduced.



Plate 10—Frangible timber posts.

### TRAFFIC DESIGN INVESTIGATIONS

There was continued activity during 1970/71 on investigation and the preparation of designs for urban and rural intersections, urban road widening and location schemes and level crossing abolition proposals. Over 120 projects were dealt with during the year.

### LINEMARKING

During 1970/71 the Board maintained traffic lines and pavement markings on a total of 6,808 route miles, consisting of 4,045 miles of freeways and State highways, 2,073 miles of other declared roads and 690 miles of unclassified roads. The work output expressed in length of equivalent standard stripe, i.e. 10 ft. x 3 in. line with 30 ft. gap, was 20,555 miles, an increase of 5.8% over the 1969/70 level.

As at 30th June, 1971, the Board has two large linemarking machines for longitudinal striping, two small machines for intersection and miscellaneous markings and a new medium size machine, which is suitable for all types of work. The main function of the medium size machine is to provide a special rapid service throughout the State on jobs which require marking before the regular visit of a large unit. The machine has proved most versatile and four similar machines are now being constructed at the Central Workshops, Syndal. A third large machine has been constructed at Syndal and is almost ready to commence work.

The expenditure on marking totalled \$412,776 during 1970/71, including \$73,500 expended by the Board's regional Divisions. The materials used consisted of 55,930 gallons of paint and 186 tons of glass beads. The average cost of linemarking with the large machines was \$12.87 per mile of standard stripe, an increase of 12.9% over 1969/70 due to a rise in cost in all phases of operations.

Approximately 14,300 raised pavement markers were installed by linemarking crews, the majority being on urban freeways, where lane lines are indicated by groups of markers consisting of one reflective marker followed by four non-reflective markers.

## TRAFFIC DATA COLLECTION

The automatic continuous counting programme which was begun in 1968/69 to provide a basis for estimating annual average daily traffic volumes (A.A.D.Ts) and design hour volumes (D.H.Vs) from short term counts was extended and modified during 1970/71 as set out below.

The number of rural continuous counting stations was increased from 28 to 40 and the number of urban stations (which are counted on a fortnight on, fortnight off basis) was increased from 12 to 14. From this programme basic traffic volume patterns are obtained for State highways. Accurate A.A.D.T. profiles are now available for most of the highways leading to Melbourne. It is planned to arrange counting on the remaining highways during 1971/72.

The automatic counting system is being modified by the introduction of induction loop detectors to replace the rubber tubes which were previously used. The induction loop detectors consist of electrified wire loops which are buried in the road surface. A transducer attached to a loop detects the presence of vehicles. The loops are not subject to wear and tear or vandalism and will be more reliable and accurate than the tube installations. In urban areas traffic counters with either 2- or 4- channel recording systems are being used in conjunction with the loop detectors, and these will give greater reliability and flexibility in use than the single channel counters previously used.

It is planned to replace eventually all the urban and rural station tube detectors with buried induction loop detectors. By 30th June, 1971, twenty-six induction loops had been installed at twelve rural locations for counting purposes. For a lane usage and freeway capacity study, forty-two loops have been installed on the Lower Yarra Freeway. Seventeen loops are also proposed to be installed on the Tullamarine Freeway for the same type of study.

In addition to the automatic counting programme, numerous other traffic studies were made. These included the continuation of the "before and after" study to determine the changes in traffic patterns associated with the operation of the Tullamarine Freeway, referred to in the 1969/70 Report, and the commencement of a similar study regarding the Lower Yarra Freeway.

In conjunction with N.A.A.S.R.A. a pilot survey on the axle loads of commercial vehicles was conducted in December, 1970, and subsequently an extensive programme of axle loading and dimension surveys was commenced at various weighbridges throughout Victoria.

The annual traffic census was conducted on Wednesday, 17th March, 1971. Twelve hour (7 a.m.-7 p.m.) classification counts were taken manually at 2,066 stations, 854 stations being on State highways. Augmented counting was conducted in Ballarat and Dandenong Divisions. The Rural Highway Traffic Index (100 in the base year 1933) rose from 1,062 in 1970 to 1,093 in 1971, an increase of 3%, which is considered normal. The Index, which indicates the growth in traffic volume, is computed from counts at seventy-six selected rural counting stations.

## WORKS SUB-BRANCH

### 1. ROAD CONSTRUCTION AND MAINTENANCE

#### ROCK ANCHORS

The Calder Freeway at Niddrie, in the City of Keilor, is constructed in cut with  $\frac{3}{4}$  to 1 batters, up to 25 feet high. The right of way is very restricted and above the batter on one side a service road has been constructed (the back of the kerb is within 5 feet of the top of the batter), and there is residential development above the batter on the other side, property lines being within 5 feet of the top of the batter.

The batter material is generally salamander (highly decomposed basalt). Although tests indicated that the batter slopes would be stable at the design slope of  $\frac{3}{4}$  to 1, it was obvious that the faces of the batters would be subject to severe weathering.

In view of the potential hazard to the land uses at the top of the batters, and the difficulties of future batter maintenance after completion of the freeway, a batter treatment providing both support and protection was considered necessary. Having regard to all the relevant circumstances it was decided that protection by crib walling should be provided. A single-cell wall design with rock anchors was adopted. For the alternative, i.e. a multi-cell crib wall, there was insufficient width available.

Tests of mechanical rock anchors were carried out at the site and it was found that such devices were not capable of developing the desired design load (i.e. 5 tons per anchor) in the batter material.

Several tests were made to develop an alternative type of rock anchor. The type found most suitable consisted of a  $\frac{1}{2}$  in. diameter steel pre-stressing strand to A.S. A142, grouted in a 3 in. diameter hole. This was stressed and anchored using a standard barrel and wedge type anchoring device. It was found that this anchor was capable of safely carrying twice the desired design load, and consequently it was possible to halve the number of anchors required.

The anchoring procedure at most locations on the job consisted of:

- (i) drilling a 3 in. diameter hole 20 ft. into the face of the batter;
- (ii) placing the pre-stressing strand in the hole and grouting the hole to the surface (the outer 10 ft. of the strand was greased and placed in a plastic sheath to prevent any bond between the strand and the grout);
- (iii) later, stressing the strand by jacking against a deadman placed in the wall. The strand could be tested to its design load, and anchored at the design load or a lower load.

The procedure was found to be both satisfactory and versatile. Only materials commonly used in post-tensioned pre-stressing work were utilized, and the depth of hole and length of strand could be varied readily. For example, if the ground was found to be of poor quality, the anchor might be made suitably longer simply by drilling a deeper hole and using a longer strand.

#### COLOURED MEDIAN SURFACING

On the eastern approach roads to the Lower Yarra freeway, it was decided not to grass the medians because of the difficulty of establishing and maintaining grass in a 12 ft. width adjacent to high density industrial traffic. The use of the normal 3 in. thick concrete paving was also rejected as it would have a rather drab appearance, particularly when it became dirty.

The use of red coloured no-fines concrete was adopted for surfacing the medians as it was considered to have a pleasant appearance and, in addition, its irregular surface would tend to diffuse headlight reflections.

After a number of tests a satisfactory surfacing material was obtained using a  $\frac{3}{8}$  in. clean uncrushed river gravel with the following grading:

B.S. sieve size:	$\frac{1}{2}$ in.	$\frac{3}{8}$ in.	$\frac{1}{4}$ in.	$\frac{3}{16}$ in.	No. 14
Percentage passing:	100%	Between 100% and 95%	Between 40% and 0%	Between 5% and 0%	Between 0.5% and 0%

The mix consisted of five parts of gravel by weight to one part of cement with  $\frac{1}{2}$  oz. of black oxide and 2 oz. of red iron oxide to each cubic foot of mix. The water/cement ratio of approximately 0.25 produced a mix having little or no slump.

The total thickness of paving used was 4 in., consisting of a  $2\frac{1}{2}$  in. base layer of conventional concrete which was allowed to reach its initial set prior to the placing of the top layer, a  $1\frac{1}{2}$  in. thickness of no-fines concrete.

The no-fines concrete was plant mixed in a pan mixer and delivered to the site in agitator trucks. It was spread roughly to level from the agitator chute and struck (tamped) off level with a wooden screed to about  $\frac{3}{8}$  in. above final level. The surface was then compacted with a 6 in. diameter smooth steel hand-drawn roller weighing about 100 lb. which was used to roll the surface in two directions at right angles to produce a flat and uniform textured surface.

Impregnated fibre-board expansion joints were placed at 40 ft. intervals along the medians.

The cost of construction for this surfacing varied from \$3.20/square yard for large open areas to \$4.20/square yard for work in confined areas where hand preparation was required.

Provided that the mix proportions and placing procedures were carefully followed and the agitator trucks were adequately cleaned prior to use, the surface obtained was uniform in texture and colour and was both functional and pleasing in appearance.

#### LIGHTWEIGHT FILLING

The design and construction of the northern approach embankment of the Graham Street overpass of the Port Melbourne railway had to take into account particular foundation difficulties.

The foundation to the embankment fill consisted of 25 ft. to 30 ft. of dense sands which overlaid 40 ft. to 80 ft. of compressible sands and silts. At a depth of 48 ft. below natural surface, the Melbourne Main Sewer, which is very old and constructed in brick, lies at right angles beneath the embankment. The sewer is in poor condition and external soil and water pressure is relied on to keep the joints tight.

The Materials Research Division tested the foundations and predicted that, with the embankment constructed fully in salamander (a decomposed basalt with a density of about 135 lb./cu. ft.) to a height of 9 ft. above natural surface on the line of the sewer, the sewer could settle between  $\frac{3}{4}$  in. and  $1\frac{1}{4}$  in. Officers of the Melbourne and Metropolitan Board of Works advised that settlements of this order and subsequent strains imposed might open the sewer joints, thus allowing water to wash the surrounding silts into the sewer, thus removing part of the external support, with the possibility of collapse of the sewer. It was considered that settlement should be kept below  $\frac{3}{4}$  in., and that this could be achieved if there was a reduction of the density of the embankment material to within the limits 81 lb./cu. ft.-95 lb./cu. ft. Field density and placing tests were carried out on samples of light weight scoria fill. From these tests it was found that:

- (i) lightweight scoria, with a minimum of fines, was required to maintain a low density. Material of nominal size  $\frac{3}{4}$  in. to 6 in. was tested, but material between  $1\frac{1}{2}$  in. and 6 in. nominal size was finally used.
- (ii) a 54 in. wide vibrating drum roller drawn by a crawler tractor was not suitable for compaction because it concentrated the fines in each compacted layer and tended to cause breakdown of the material;
- (iii) the scoria could not be compacted unless laterally confined;
- (iv) satisfactory densities between 71 lb./cu. ft. and 81 lb./cu. ft. were achievable.

It was decided to construct the section of the embankment over the sewer principally with lightweight scoria fill and the adjacent sections with salamander fill. The salamander sections were battered towards the scoria section with the toe of each batter 40 ft. clear of the line of the sewer.

A cross section of the section above the sewer and the corresponding soil pressure diagram, are shown at Figure 5. A series of berms 2 ft. high and 5 ft. wide were constructed with salamander along both of the outside edges of the embankment to confine the scoria. Pressure was developed as shown in the diagram, and a maximum of 85 lb./cu. ft. for the average density of the fill, including the pavement, was achieved.

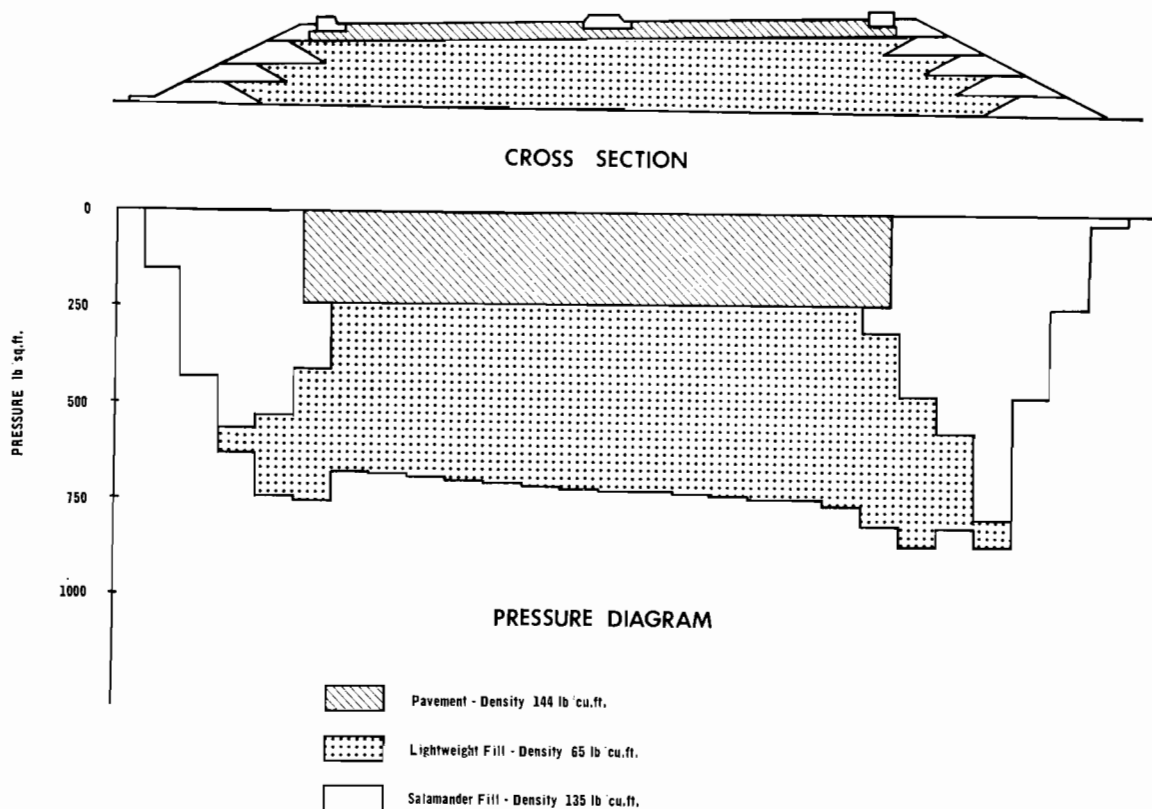

Figure 5—Graham Street Overpass, northern approach embankment. Cross section and corresponding pressure diagram.

It was found that 20 ton and 12 ton multi-wheel rollers could not develop traction on the loose scoria. The technique was developed of spreading the scoria with a light duty pneumatic tyred front-end loader. Compaction was then effected with a Bomag BW 75 hand operated diesel powered vibrating roller weighing 1870 lb. This unit has two 30 in. wide x 20 in. diameter drums in tandem, which vibrate in opposition at 60 cycles per second.

In order to produce a working surface, two passes were made without vibration, followed by six passes with vibration. The Bomag roller was able to vibrate and rotate the scoria until it reached a stable condition of maximum density, yet this roller did not cause the breakdown or concentration of fines associated with the larger drawn rollers.

A 2 in. layer of  $\frac{3}{8}$  in. scoria was used to blind the upper surface of the coarse scoria prior to the placing of the flexible pavements. The cost of supply for the  $1\frac{1}{2}$  in.-6 in. scoria was \$3.40/cu. yd. and for the  $\frac{3}{8}$  in. material, \$4.30/cu. yd.

The embankment has been trafficked since October, 1970, and there have been no visible signs of deflection of either the light weight section or the adjacent salamander sections. The higher portions of the embankment had settled 7 in. in some four months under a 5 ft. surcharge loading during construction.

#### CONTINUOUSLY REINFORCED CONCRETE PAVEMENT

The reconstruction of Boundary and Montague Streets, South Melbourne, as an eastern approach to the Lower Yarra Freeway, involved the construction of a continuously reinforced concrete ("C.R.C.") pavement which is 3,500 ft. in length and provides four traffic lanes.

At the site there were poor subgrade conditions with California Bearing Ratios as low as 1% to 2%, and extensive, relatively shallow public utility assets. Had the use of C.R.C. pavement not been adopted, the above factors would have necessitated an excessive depth of flexible pavement construction and extensive and costly relocation of the public utility assets. The shallower concrete pavement was the more economical solution.

The utilisation of C.R.C. pavement construction enables long sections to be built without installing the traditional transverse joints, the only transverse joints used being construction joints placed at the end of each day's work. Terminal joints are placed where the pavement ends at a structure or abuts an existing pavement. Figure 6 illustrates the type of joints used.

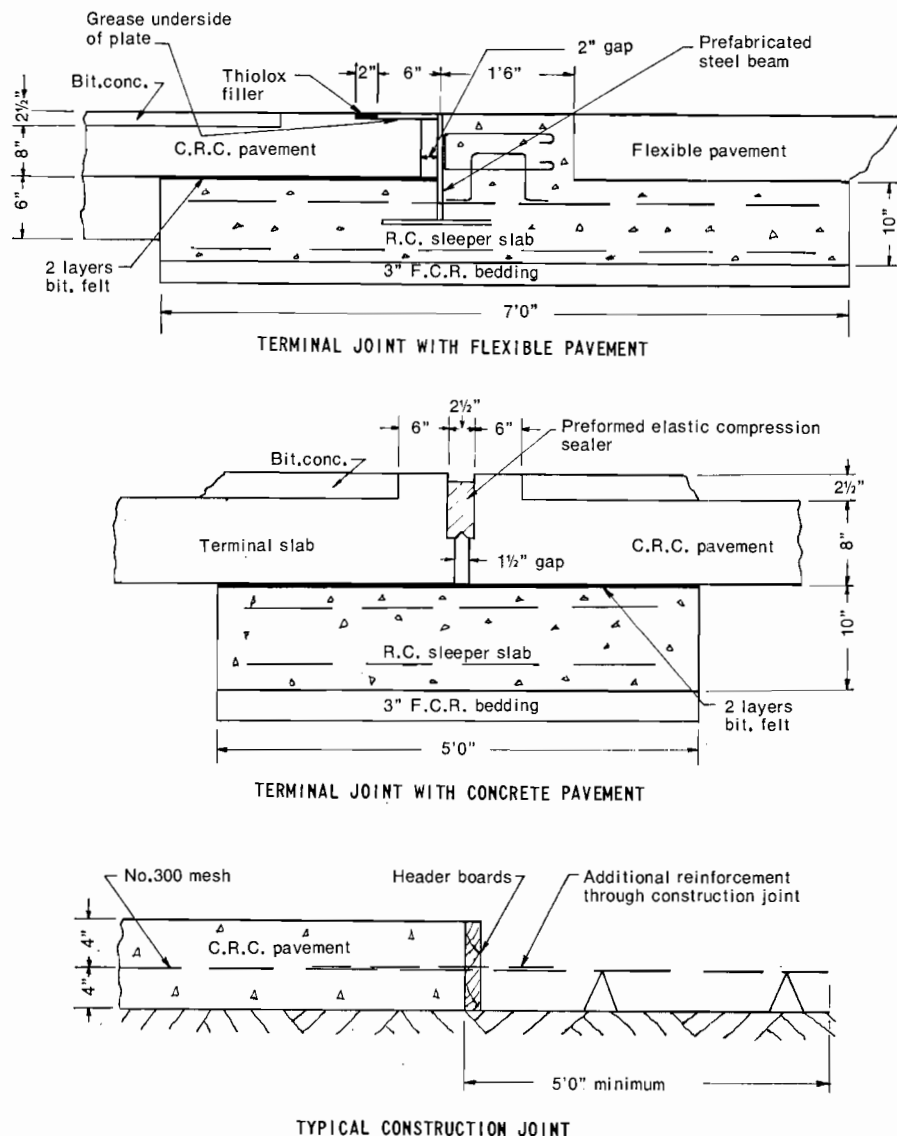

Figure 6—C.R.C. pavement. Details of terminal joints and a construction joint.



Cracks which result from stress relief in the C.R.C. pavement, occur at close intervals of approximately ten feet, and are kept small and tightly closed by the action of the continuous steel reinforcement.

The pavement adopted and the contract prices were as follows:

2½ in. bituminous concrete*	—
8 in. C.R.C. pavement	\$7.65/sq. yd.
6 in. five % cement stabilized crushed rock	\$2.00/sq. yd.

(\*The bituminous concrete will be provided in due course to improve the pavement riding surface qualities, but its provision has been deferred for the time being to permit observation of the concrete pavement for as long as possible.)

The design of the pavement was evolved from overseas practice. No allowance was made in the structural design for the additional strength obtained from the bituminous concrete overlay. Design details for the C.R.C. slab are as follows:

- (i) concrete thickness, 8 in.;
- (ii) reinforcing steel, mesh No. 300 to A.S. A84, equivalent to 0.6% of the slab cross section and located centrally in the slab;
- (iii) nominal mean 7 day flexural strength of concrete, 600 p.s.i.;
- (iv) change in length at terminal joints,  $\pm 1\frac{1}{2}$  in.

The width of the slabs varied between 14 ft. 6 in. and 22 ft. Although the specifications provided for the use of a paving and finishing train if a contractor so desired, the construction was carried out basically by hand methods owing to the relatively complicated road layout, involving traffic islands, service manholes and changes in lane width.

After the cement treated crushed rock had been trimmed, the steel formwork was set to level and held in position with steel pegs driven into the crushed rock. The steel reinforcement in sheets 20 ft. x 8 ft. was placed by hand at the mid-depth of the slab and supported by steel chairs. The mesh sheets overlapped 1 ft. 6 in. except at construction joints, where the required overlap was 3 ft. The concrete was vibrated by both immersion vibrators and an external vibrating screed. Finishing was carried out with hand floats and a transverse hessian drag. Curing of the concrete was effected with wetted hessian for twenty-four hours, followed immediately by the use of heavy polythene sheets for a further six days. Within two days of placing the concrete, a central saw cut 1½ in. deep was made in the 22 ft. wide slabs.

As the concrete pavement design was based on flexural strength, testing of this feature was the basis of acceptance for concrete quality. The mean 7 day flexural strength obtained was 564 p.s.i. For information, compressive strength tests were made, the mean 28 day strength being 4,450 p.s.i. (6 bag mix).

The Materials Research Division installed strain gauges and thermocouples in a section of the concrete pavement in order to measure the strains in the concrete and the steel, and temperature gradients through the concrete for comparison with design assumptions. This investigation had not been completed as at 30th June, 1971.

With the very poor subgrade conditions prevailing, the C.R.C. pavement was considered structurally and economically successful and a suitable method for use in other similar situations. However, the standard of riding surface achieved using hand finishing methods would be unsatisfactory for freeway applications, despite the rigid level control of  $\pm \frac{1}{8}$  in. on the concrete formwork, unless a bituminous concrete overlay was added.

## SAND DRIFT CONTROL

The work on sand drift control in Geelong Division which was referred to in the 1967/68 Annual Report is continuing, and some features of the work since 1967 are described below.

In 1970 the area under treatment adjacent to a length of the road between Barwon Heads and Torquay was increased from ten acres to thirteen acres. The area is fenced off from the road to assist the growth of naturally occurring vegetation and to reduce pedestrian traffic. However, it has been observed that surfers have sometimes cut the wires of the protective fencing in order to gain access to surfing beaches.

Within the fenced areas the numerous gullies and blowouts are closed off near the beach with 3 ft. high slat fencing, in the lee of which a drift builds up. Figure 7 shows how a particular gully has filled with sand by repetitive installation of slat fencing. The seasonal rates of deposition of sand are indicated in Figure 8.

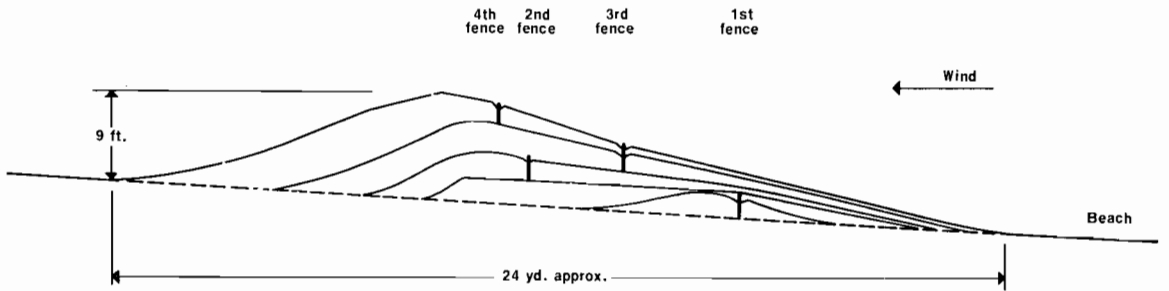

Figure 7—Side elevation of "Gully 20", showing the accumulation of sand over a period of two years.

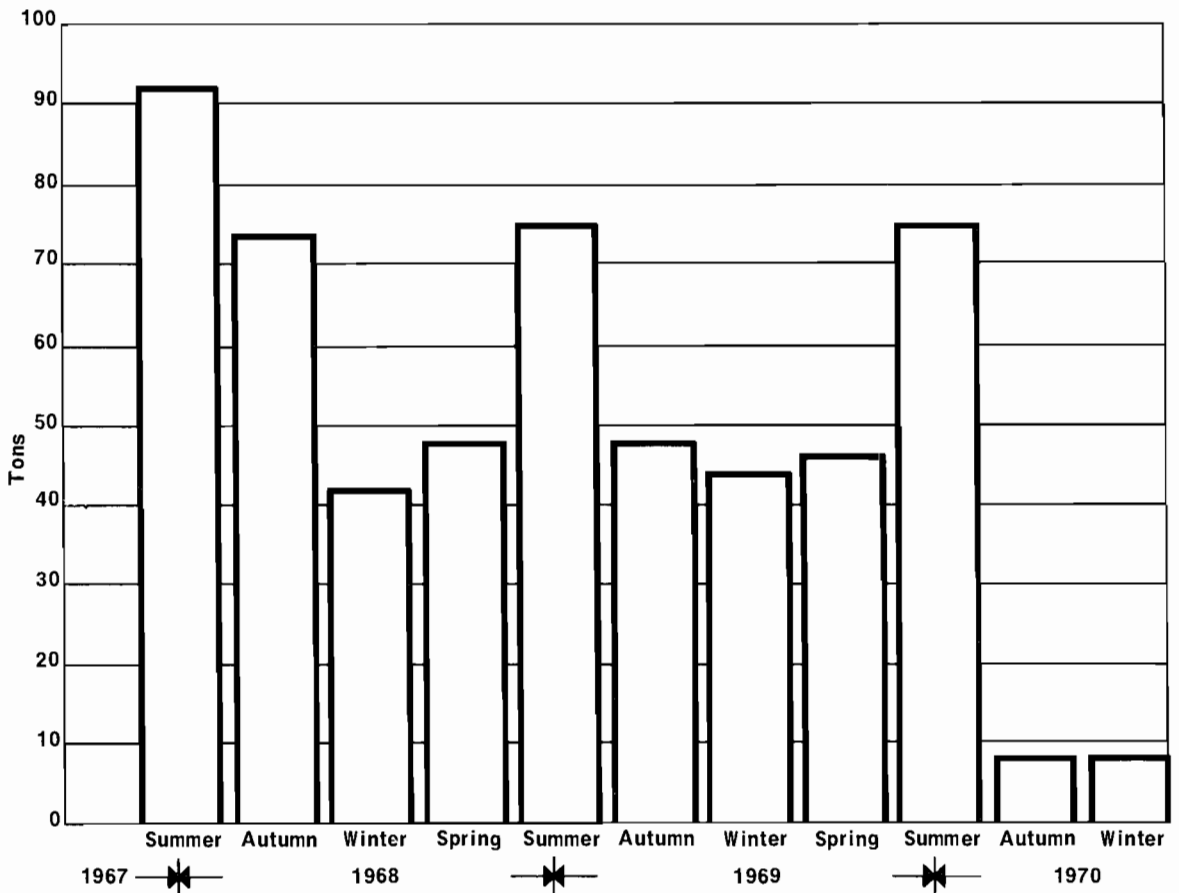

Figure 8—Seasonal rates of deposition of sand at "Gully 20". The high rates of deposition in the summer of 1967/68 and the following autumn were associated with drought conditions, and the low rates for the autumn and winter of 1970 were associated with unusually wet conditions. The prevailing wind in summer is on-shore and this, together with dry summer conditions, leads to the summer maxima.

The cost of preventing sand from reaching the road by storing it at slat fences near the beach is \$0.14 per cu. yd. compared with costs between \$0.38 and \$0.51 per cu. yd. for removing sand from the road.

In some areas the dunes are so much eroded by the wind that it has been necessary to use dozers and traxcavators to reshape them. Figure 9 shows the designed aerodynamic profile for dune No. 42, and also the profile to which the dune tends to revert.

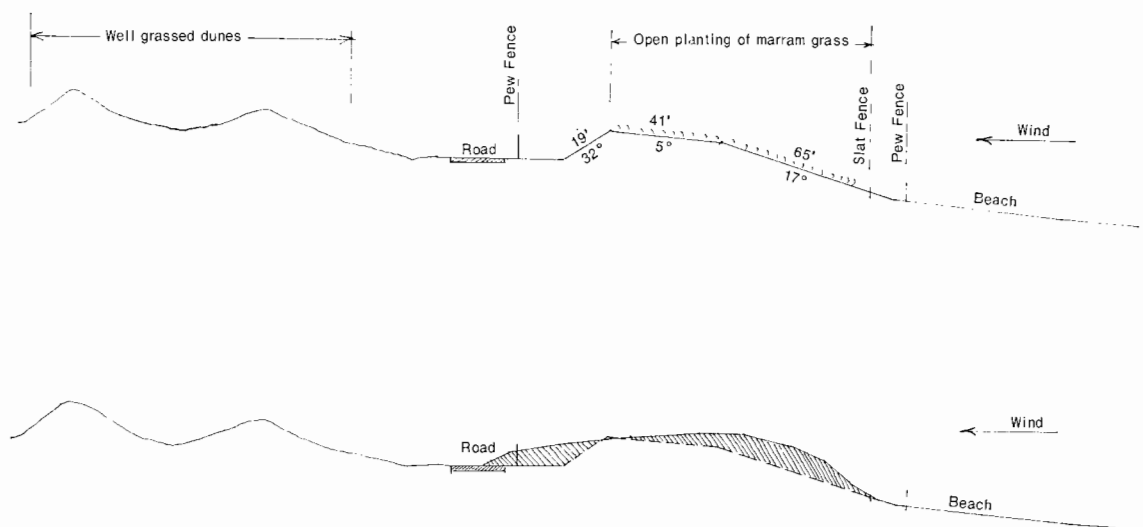

Figure 9—  
 Top: designed profile of "Dune 42".  
 Bottom: profile towards which the dune tends to revert. Regular maintenance is needed to counteract this tendency.

After a dune has been reshaped, it is planted with marram grass (*ammophila arenaria*). Most plantings in 1967 failed owing to severe drought conditions but the plantings since have been successful. It has been found necessary to plant the grass 12 in. deep in order to ensure access to adequate moisture reserves. The following table of moisture contents of the sand indicates the scarcity of moisture near the surface:

Depth below surface	M.C. by weight after 2 days of heavy cold rain (18/8/70)	M.C. by weight after 1½ days of heavy intermittent showers (31/8/70)
0 in.	0.7%	1.2%
4 in.	5.6%	6.9%
8 in.	6.2%	7.7%
12 in.	6.9%	7.7%
15 in.	7.2%	7.3%
18 in.	—	6.4%
24 in.	—	6.2%

In general the marram grass is planted in rows roughly parallel to the beach and between 18 in. and 3 ft. to 4 ft. apart. The clumps are spaced at intervals of 18 in. In some cases where 4 ft. spacing between rows has permitted sand drifts to penetrate the full depth of the planted area, additional rows have been planted in the second year to reduce the spacing to 2 ft.

In addition to varying the row spacing, other measures are taken to reduce the movement of sand. Short branches from cypress trees are laid on the sand on the windward side of a clump of grass to act as a sand collector and to prevent erosion from occurring in front of the clump. In areas where the distance between the beach and the road is short and maximum resistance to sand movement is required the marram grass is left uncut at a height of 12 in. to 15 in., although in some areas the tops of the clumps have been cut in conformity with the normal planting practice.

Nitrogen and phosphorus in a variety of artificial fertilizers have been applied at rates of 150 lb. N<sub>2</sub> per acre and 50 lb. P<sub>2</sub>O<sub>5</sub> per acre respectively. The pH value of the sand is approximately 8 to 8.5.

During 1970 tree planting on the landward side of the road was started with the object of creating a shelter belt which will protect the dunes from off-shore winds (Figure 10). Twenty rows of trees on a 15 ft. grid were planted along 600 lineal ft. of road. The species used were:

<i>Acacia longifolia</i>	Sallow wattle
<i>Acacia sophorae</i>	Coast wattle
<i>Casuarina stricta</i>	Drooping sheoke
<i>Cupressus arizonica</i>	Arizona cypress
<i>Eucalyptus gomphocephala</i>	Tuart
<i>Hakea suaveolens</i>	Sweet-scented hakea
<i>Leptospermum laevigatum</i>	Coastal tea-tree
<i>Melaleuca armillaris</i>	Bracelet honeymyrtle
<i>Myoporum insulare</i>	Boobiolla
<i>Pinus pinaster</i>	Maritime pine

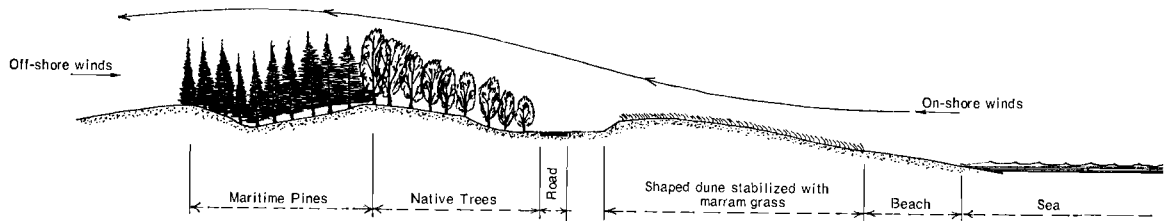

Figure 10—Side elevation of a stabilized frontal dune and shelter belt of trees.

#### FOAMED BITUMEN STABILIZATION OF NON-COHESIVE SANDS

Following a trial at Cranbourne in 1969, foamed bitumen stabilized sand was used as a 6 in. sub-base layer for the construction of 2.3 miles of the Frankston Freeway during 1970. The pavement composition was as follows:

1½ in.	of ¾ in. B.C. (1 in. of B.C. to be added later)
6 in.	of ¾ in. wetmix F.C.R.
4 in.	of 1½ in. C.R.
6 in.	of sub-base
<hr/>	
17½ in.	

The work was carried out by contract and the specification provided for three alternative sub-base treatments to enable relative comparisons to be made of cost, strength of finished pavement, and the construction difficulties encountered. The three types of treatment, quantities used and the schedule prices were as follows:

- |  |                |
|--|----------------|
| (a) 3% by weight foamed R 90 bitumen stabilizing of <i>in situ</i> sand (62,000 sq. yd.) | \$0.82/sq. yd. |
| (b) 4% by weight cement stabilizing of <i>in situ</i> sand (7,000 sq. yd.)               | \$0.78/sq. yd. |
| (c) 2 in. nominal size crushed rock, supply and place (20,000 sq. yd.)                   | \$0.78/sq. yd. |

Where necessary the *in situ* sand used in treatments (a) and (b) was supplemented with an imported coarse dune sand. These sands are free running (non-cohesive), having adequate strength when confined but, due to difficulties in handling and compacting, unusable as an effective pavement material without stabilizing to provide some cohesive strength.

Foamed bitumen stabilization involves mixing bitumen in a foamed state with suitable soil or aggregate, followed by the compaction and curing of the stabilized material. One method of producing foamed bitumen uses wet steam and patented concentric jets, steam being passed through the inner jet and bitumen through the outer jet. When foamed, the bitumen expands approximately tenfold and has improved wetting properties. The moisture content of the material being stabilized must be within narrow limits (generally less than optimum moisture content), for satisfactory mixing to be obtained.

The equipment used by the approved sub-contractor was a three rotor P. & H. stabilizing machine fitted with a steam generator, which pushed a 1,000 gallon bitumen tanker. The tanker was fitted with balloon tyres to aid manoeuvrability over the sand. The normal rate

of progress was 27 ft. per minute. To obtain the required bitumen content of 3% by weight a bitumen pressure at the jets of 18-20 p.s.i. was required (varied according to the bitumen temperature which was generally 350°-370°F). The optimum steam pressure for the foaming process was about 40 p.s.i. The average rate of work was about 2,500 sq. yd. per day (equivalent to 4,000 gallons of bitumen). The equipment was generally satisfactory but trouble was experienced in the operation of the steam generating plant used in the production of the foamed bitumen. The steam foaming process has since been replaced by a cold water foaming process.

Bitumen content was required to be within 0.5% by weight of the specified 3%. To enable rapid on-site checks of bitumen content to be made a temperature corrected application rate (in gallons of bitumen per square yard per 6 in. compacted depth) was calculated, and the bitumen tanker dipped at the start and finish of each run. Unless the extraction test was carried out immediately after stabilization and prior to compaction, laboratory extractions of bitumen from the stabilized sand (using trichlorethylene solvent, C.R.B. Test Method 210) were found to correlate poorly with the known application rate. On investigation it was observed that the grading of the extracted sand was significantly coarser than for the sand before bitumen treatment. Microscopic examination showed that some of the sand particles were stained by bitumen and that in some cases particles were stuck together with bitumen to form larger particles. Oxidation at 900°C was necessary to remove the remaining bitumen. However, this is not a practical extraction process.

Generally the sand and foamed bitumen mixed well, with the cured material presenting a uniform appearance. A more uniform mixture resulted where the sand was higher in fines which aided the distribution of bitumen and particle coating. Difficulty was experienced in obtaining satisfactory mixing during July and August when the ground temperature was low and the bitumen chilled. To overcome this problem the bitumen temperature was raised to 400°F with the jet pressure reduced to compensate.

A problem also existed during the wetter months in ensuring that the sand had the moisture content of 3%-5% less than optimum, which was required for satisfactory mixing and subsequent curing. This problem was accentuated in the lower-lying areas of the project where the sand was close to the water table level, and in some instances the wet *in situ* sand was removed and replaced with drier imported material which was then stabilized.

Compaction was successfully achieved with a drawn plain drum vibrating roller and two self-propelled multi-wheel rollers. After two days during which the sections cured and were rolled with the multi-wheel rollers, proof rolling was carried out with a fully ballasted 35 ton multi-wheel roller to detect any poorly mixed or wet areas. The sections were then covered with a thin layer of the intermediate course crushed rock which protected the sub-base from the construction vehicles as further works proceeded. The stabilized sub-base layer acted as an ideal platform for further construction activities.

In the section where 2 in. nominal size crushed rock was used as the sub-base it was found that the *in situ* sand of the sub-grade permeated through the sub-base into the 4 in. intermediate course layer of 1½ in. crushed rock, but there was no indication of such penetration through the foamed bitumen stabilized sand sub-base.

Considerable further testing of the completed pavements will be required before any exact comparisons of strength can be made. At this time there is no noticeable difference between the pavements over the different sub-base types.

Further investigation has indicated that the bitumen content could be effectively lowered to 2%-2½% by weight, resulting in a reduced cost which will compare more than favourably with the alternatives on the future stages of the project.

General aspects of bituminous stabilization are dealt with under the heading "Bituminous Stabilization" in this Report.

DIRECT LABOUR ROAD CONSTRUCTION COSTS

Tables 1 to 4 set out analyses of the costs of 72 construction and reconstruction jobs completed by direct labour by the Board during 1970/71. The information on unit costs is not directly comparable with corresponding information from previous years and is not necessarily indicative of cost trends, because of variations each year in the number of cost statements submitted, regional differences and factors relating to the types of jobs costed. A committee has been established by the Board to investigate these and other problems on costing.

**TABLE 1—**

**DISTRIBUTION OF EXPENDITURE**

	1970/71	Five Year Average 1966/67 to 1970/71
	%	%
Plant	33.9	35.3
Labour	34.3	32.8
Materials	20.7	23.0
Stores	11.1	8.9

**TABLE 2—**

**WORKS OVERHEAD EXPENDITURE**  
(Percentage of productive costs)

	1970/71	Five Year Average 1966/67 to 1970/71
	%	%
Construction overhead expenses	14.9	12.1
Camp expenses	11.0	11.7
	25.9%	23.8%

**TABLE 3—FORMATION COSTS**

(Including distributed overhead expenditure)

	Rock		Earth Unclassified		Total	
	Quantity	Unit Cost	Quantity	Unit Cost	Quantity	Unit Cost
	cu. yd.	\$	cu. yd.	\$	cu. yd.	\$
1970/71	45,833	1.46	1,569,324	1.17	1,617,524	1.18
Five year average 1966/67 to 1970/71	182,666	1.49	1,489,403	1.11	1,672,069	1.15

**TABLE 4—PAVEMENT COSTS**

(Consolidated in place including distributed overheads)

	Fine Crushed Rock		Coarse Crushed Rock		Gravel, etc.		Total	
	Quantity	Unit Cost	Quantity	Unit Cost	Quantity	Unit Cost	Quantity	Unit Cost
	cu. yd.	\$	cu. yd.	\$	cu. yd.	\$	cu. yd.	\$
1970/71	95,123	5.02	77,508	4.77	770,050	2.30	942,681	2.78
Five year average 1966/67 to 1970/71	97,272	4.98	52,668	4.61	963,177	2.17	1,113,117	2.53

## 2. TESTING OF MATERIALS AND RESEARCH

### FRICION WELDING OF STUD SHEAR CONNECTORS

A prototype friction welding machine has been designed and built by the Board to investigate the use of friction welding for attaching stud shear connectors to the flanges of mild steel bridge girders (Plate 11).

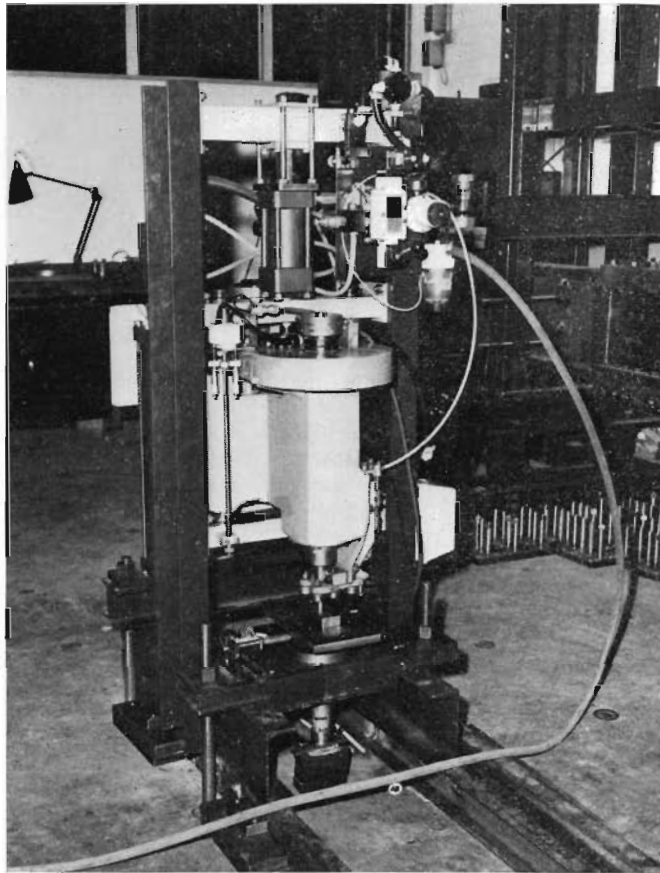

Plate 11—Prototype friction welding machine.

The friction welding sequence is commenced with the stud being manually placed in the chuck of the machine and the required amount of "burn-off displacement" and "forging displacement" (terms explained below) being set on two micrometer-actuated limit switches. The 13.5 h.p. motor, which is connected to the chuck through an air clutch and a belt drive, is then started. From this point on the welding sequence is automatic, being controlled by air operated solenoids and time delay units. The stud is clamped in the chuck, the air clutch is engaged and the stud spins at 1,500 r.p.m. Axial pressure is applied to the stud to produce friction between the stud and the base plate. When the stud-to-base plate interface temperature is high enough to reduce the yield stress of the stud to less than the axial pressure, the stud end plastically deforms and "burn-off displacement" occurs, i.e. the length of the stud is reduced owing to the plastic deformation. When the amount of burn-off displacement initially set on the displacement micrometer is reached, the clutch automatically disengages and the stud stops spinning almost immediately. At this point, while the metals are still hot and plastic, a forging displacement is produced, i.e., sufficient axial pressure is maintained to displace the stud axially towards the base plate by 0.01 in. The cross-section of a friction welded stud is shown at Plate 12.

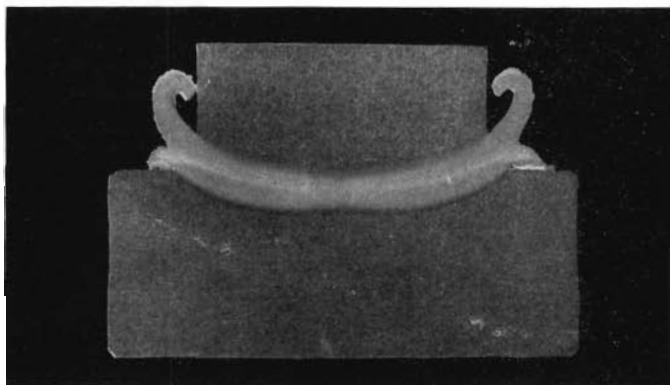

Plate 12—Cross section of a  $\frac{3}{4}$  in. friction welded stud, x 2.



The welding time depends on the stud diameter, axial pressure and burn-off displacement used. A typical time for a  $\frac{3}{4}$  in. stud at 20,000 p.s.i. axial pressure and 0.100 in. burn-off displacement is two seconds. A 1 in. stud at an axial pressure of 11,000 p.s.i. and 0.100 in. burn-off displacement can be welded in six seconds.

Instrumentation has been arranged to record continuously during the weld cycle the axial load on the stud, the displacement of the stud relative to the plate surface, the rotational speed of the stud, and the torque produced in the base plate.

Mild steel studs of  $\frac{3}{4}$  in., 1 in.,  $1\frac{1}{8}$  in., and  $1\frac{1}{4}$  in. diameter have been attached to mild steel girders. Tensile tests have indicated that joint strengths consistently in excess of 60,000 p.s.i. can be achieved with axial pressures greater than 11,000 p.s.i.

A production machine has been designed and is being built, for use by the steel fabrication shop at Syndal.

#### SLIP BASE LIGHT POLES

A slip base light pole is designed to separate from the base when hit by a vehicle, thereby reducing the force of impact and the likelihood of serious injury to the occupants of the vehicle. The slip base (Plate 13) consists of two plates with a 20 gauge steel keeper sheet between the plates. The base of the light pole is bolted to the top plate and the bottom plate is bolted to a concrete foundation block. Both plates have three corresponding V-notches at the periphery and the keeper sheet has holes corresponding with the V-notches. Bolts tightened to a specified torque extend through the V-notches and the holes in the keeper sheet. The keeper sheet ensures that the bolts will not move out of the V-notches in normal circumstances. However, under the force of a collision, the keeper plate will rupture, thus permitting the bolts to be forced out of the V-notches and the two plates to slip apart.

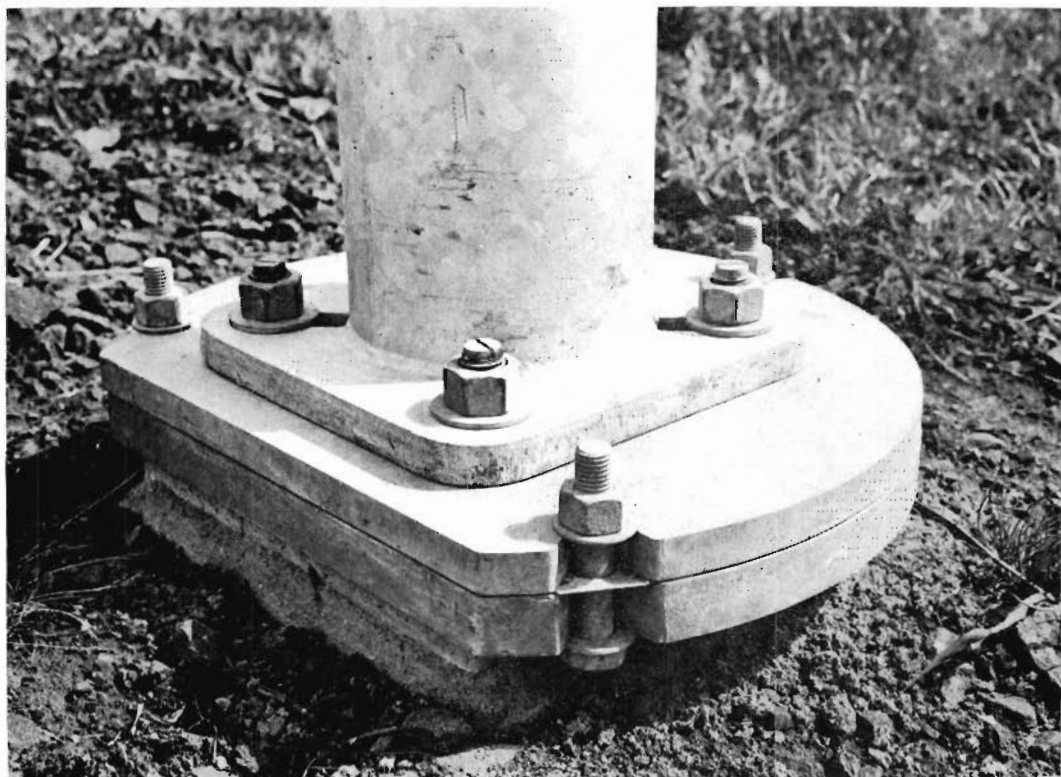

*Plate 13—A slip base assembly. In the foreground can be seen the V-notches in the top and bottom slip base plates, the keeper sheet between the plates, and one of the bolts that hold the plates and sheets together.*

In order to test the performance of slip base light poles intended for use at particular locations on freeways, a short testing programme was carried out at the Central Depot, Syndal. The programme consisted of two parts, as follows:

(i) Ballistic pendulum tests.

A 1,000 lb. pendulum weight was dropped from 14.8 ft. to strike a pole stub (Plate 14). From these tests were determined—

- (a) the action of the slip base assembly and the electrical disconnecter;
- (b) the effect of varying the slip base assembly bolt torque on the energy required to slip the pole stub.



*Plate 14—Ballistic pendulum test.*

(ii) Full scale collision test.

A station wagon was towed along a rail so that it collided with a 30 ft. high slip base pole at a nominal speed of 35 m.p.h. (Plate 15). The actual speed at impact was 32.5 m.p.h., reducing to 28 m.p.h. after collision.

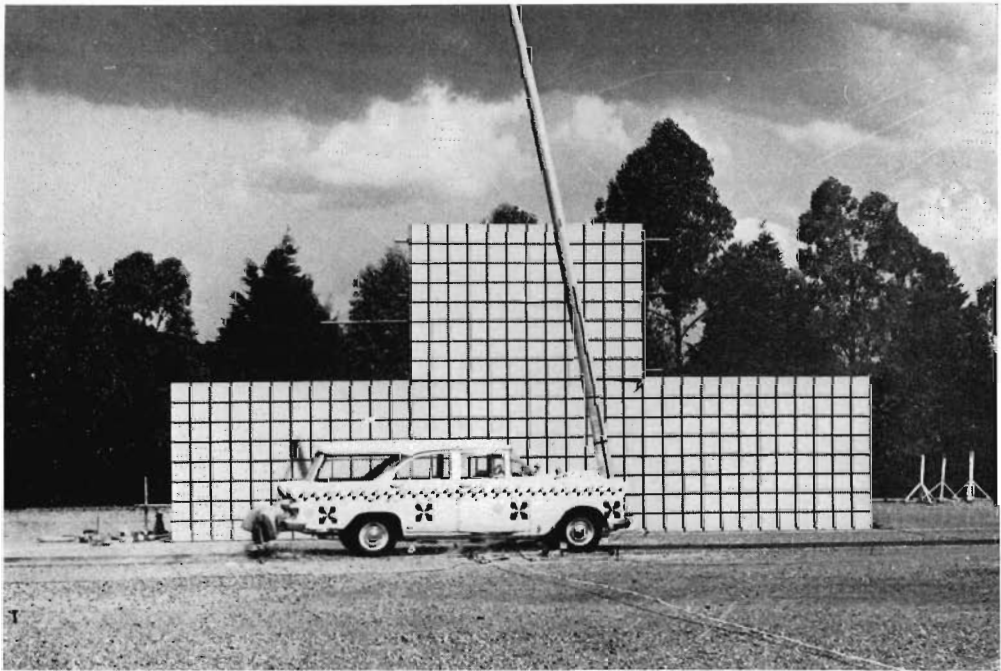

*Plate 15—Full scale collision test. Light pole falling just after collision.*

The pole behaved in a similar manner to poles of a similar slip base design tested overseas. The pole slid off its base, was thrown into the air and bounced off the car roof. The final position of the pole on the ground was clear of the assumed freeway line. Damage to the pole was minor, the cantilever arm being slightly bent and the luminaire smashed.

The vehicle received a maximum frontal deformation of 16 in., resulting in a smashed radiator and fan but no apparent movement of the engine. The roof was dented where the pole landed.

It was concluded that, although the slip base had performed reasonably satisfactorily, its performance could be improved with the probability of lessening both damage to the vehicle and injury to the occupants, by reducing the slip base bolt torque from 80 ft./lb.f. to 60 ft./lb.f.

## PILE LOADING TESTS

Load tests have been carried out on prebored piles cast into the Tertiary clayey sands at the intersection of Gladstone Road with the Mulgrave Freeway at Dandenong North. The Board's 500 ton capacity hydraulic jack and pumping equipment were utilised. Reaction was provided by 2 x 250 ton capacity high tensile cables grouted into mudstone at a depth of 100 ft. (Plate 16).

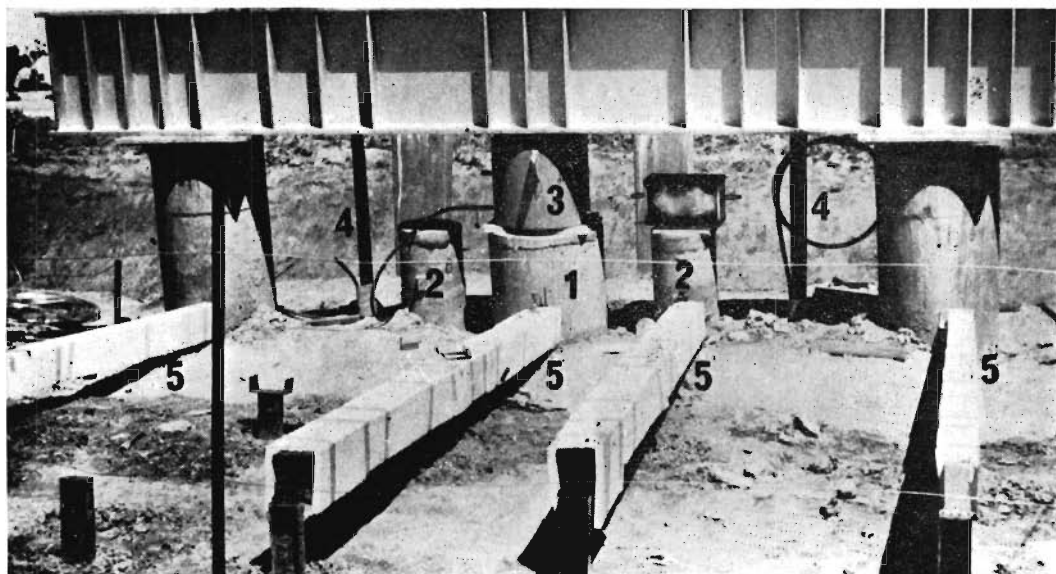

Plate 16—Gladstone Road pile loading study.

- (1) Main test pile, 22 in. diameter.
- (2) Other test piles, 13 in. diameter.
- (3) Hydraulic jack.
- (4) Anchor cables.
- (5) Datum beams, simply supported and covered with polystyrene foam to reduce temperature effects.

Three test piles were cast with false bottoms of polystyrene foam. The foam was dissolved and the piles were loaded initially in side friction only, and then in side friction and end bearing. The tests showed that the piles had an ultimate side friction capacity of 7.3 kip./ft.<sup>2</sup> and an ultimate end bearing capacity of more than 370 kip./ft.<sup>2</sup>. These values are much higher than those predicted by common design methods and allowed the 24 ft. long piles used in the Gladstone Road/Mulgrave Freeway grade separation to be decreased in diameter from 30 in. to 18 in.

The results may be applied to other areas where similar Tertiary clayey sands occur, particularly at the nearby proposed Mulgrave/Scoresby Freeways interchange.

## BITUMINOUS STABILIZATION

Bituminous stabilization of a soil or a soil/aggregate mixture is usually intended either to waterproof the material and to make it more stable in the presence of increased moisture, or to make non-plastic materials more cohesive.

A wide range of materials such as pit-run gravels, crushed rocks, sands and sandy clays which can be readily pulverized by construction equipment may be bitumen stabilized. Various bituminous materials, such as foamed and cutback bitumens and bitumen emulsions, can be used as stabilizing agents. Additives such as anti-stripping agents or surface-active agents are often added to the bituminous materials before mixing to improve their dispersion in the soil and their adhesion to the soil. These agents are added in the small proportions of 0.3% to 1.0% by weight of residual bituminous material.

The most suitable type of stabilization is best determined by laboratory investigation, with consideration being given to the soil characteristics, climatic conditions, type of mixing equipment and any other relevant factors.

The Board has laboratory apparatus (Plate 17) capable of producing foamed bitumen for testing purposes. The materials being used in field trials of foamed bitumen stabilization are evaluated with this apparatus.

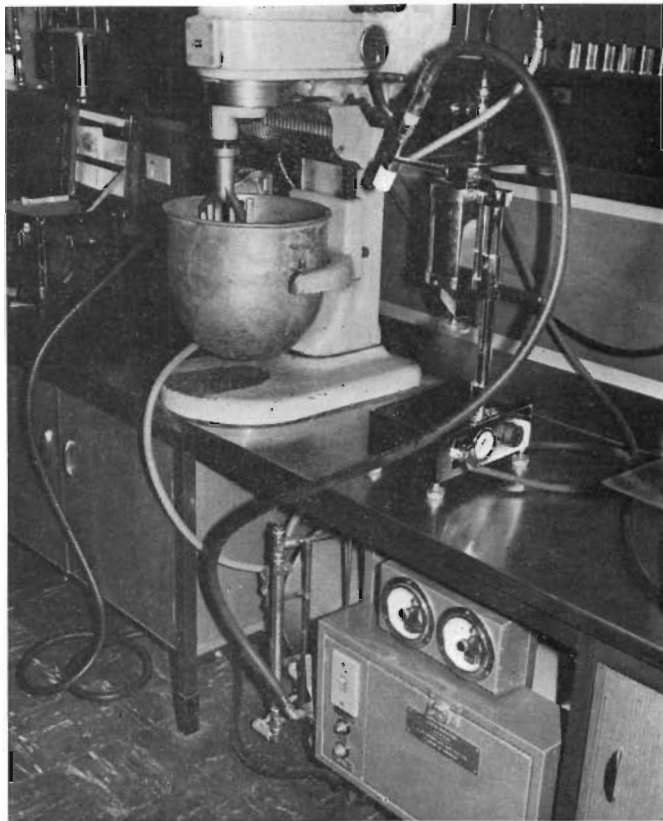

*Plate 17—Laboratory apparatus for production of foamed bitumen for testing purposes. A measured quantity of bitumen is held in the cylinder at the top right of the photograph. Compressed air is used to force the bitumen up into the nozzle to the left of the cylinder. Steam from the generator below the bench passes through the same nozzle and causes the bitumen to foam or expand. The foamed bitumen is mixed with soil in the bowl beneath the mixer.*

Mix design criteria are not well established at this stage but tentative criteria have been established, based on strength requirements and the effects of water absorption. The procedure used to select suitable soil/bitumen mixtures involves determination of material grading, Plasticity Index, and moisture/density relationships for the range of bitumen contents selected. After laboratory mixing, the testing procedure involves suitable curing procedures, the choice of which will be influenced by the climate and the plant likely to be used on the job.

In Victoria bituminous stabilization has been used in several regional Divisions (Plate 18), and field tests to evaluate its performance are now in progress (for further information, see the item in this Report, "Foamed Bitumen Stabilization of Non-cohesive Sands").



*Plate 18—Bitumen stabilization of scoria tuff, Princes Highway West, Warrnambool Division.*

It has been found essential to take cognizance of the following construction requirements:

- (a) The addition of bituminous materials to soil should not raise the "total fluids" content above optimum by more than about 1%, otherwise adequate compaction will be difficult. Control of moisture prior to stabilization is therefore important.
- (b) Curing of the mixture after stabilization to reduce the moisture content is important to enable it to gain maximum strength. However, if, as may occur in southern Victorian regions, the moisture content cannot be lowered enough before sealing, then the test method should evaluate the strength at the higher moisture content.

#### ROAD ROUGHNESS AND PAVEMENT SERVICEABILITY

The purpose of roads is to provide a safe, comfortable and economical means of transporting people and goods. This concept led American engineers in the early 1930s to try to assess how well the travelling public thought itself served by selected road pavements, and to relate these opinions to objective measurements of the various physical features of these pavements. From their investigations they found that there was a high correlation between subjective opinions on serviceability and surface roughness as measured by various instruments.

The Country Roads Board also began in the early 1930s to assess pavement riding quality by using an instrument which measured the vertical movement of a car axle relative to the chassis. This instrument was used for some ten years but was then discarded because of the difficulty in obtaining consistent results. In 1946 the Board purchased a U.S. Bureau of Public Roads (B.P.R.) roughometer which is a single wheel trailer with the wheel supported in a heavy chassis by two leaf springs, the vertical motion of the wheel being damped. The unit is towed at 20 m.p.h. and the vertical movements of the wheel relative to the chassis are summed and recorded, the roughness index being expressed as in./mile. The roughometer was used mainly to indicate the road pavements whose riding quality was in need of improvement by the use of drag-spread regulating courses. Its use was discontinued when drag-spread regulating ceased in the early 1950s.

Later, when the concept of "present serviceability" was developed in the U.S.A., the Board again became interested in the roughometer. During 1964 considerable work was done in improving the operation of the instrument. In 1965 a study was carried out to correlate the roughness index measured by the roughometer, with the opinions of a group of Board engineers regarding the present serviceability of forty-five sections of rural State highways near Melbourne. The members of the group were asked to rate the riding qualities of the sections according to a numerical scale from 0 to 5. This study produced the predicting equation which is still used for determining the serviceability of the Board's highways (for further details, see the Chief Engineer's Report of 1967/68).

Although the B.P.R. roughometer is probably one of the most widely used, it has mechanical problems and its operating speed of 20 m.p.h. is slow for routine work. A much simpler roughometer, known as the N.A.A.S.R.A. Roughness Meter, has recently been evaluated by the Australian Road Research Board and supplied to each of the Australian State Road Authorities. This instrument is fitted to a conventional station sedan and measures the relative vertical movement in one direction between the differential housing and the vehicle body. The movements are transmitted by a spring-tensioned chain drive through two clutches to a counter. The roughness index is again expressed as in./mile. The instrument can be used at speeds ranging from 30 m.p.h. to 60 m.p.h. The effect of speed on the roughometer readings between these limits has still to be assessed.

The Board is now planning a rating study similar to the 1965 study, in order to determine the predicting equation to be used with the new roughometer. It is expected that this study will be completed early in the second half of 1971.

#### GUIDE-POST PAINT

The main requirement of a guide-post is that it be readily visible to motorists. The paint used for painting guide-posts should be acceptable in respect to this important objective as well as other factors outlined below. A specification has been devised according to these criteria and a contract has been let for supply over a two-year period.

The main features of the specification are as follows:

- (a) The paint is a water-borne acrylic latex, which can be stored for over six months without appreciable change. It spreads easily on damp and poorly prepared surfaces and adheres firmly. Most blemishes can be covered by a single coat.
- (b) The paint dries rapidly, except in the most humid conditions. It produces a film which will cure within twenty-four hours, even when the temperature is near freezing point. The collection of dirt by the wet or uncured film is thus minimized.
- (c) White has been specified as it reflects more of the incident light than do other colours, and the contrast of white with most backgrounds is as good as for any other colour.

- (d) The dry paint film chalks rapidly. Thus, it constantly sheds dirt and exposes a fresh white surface. The film ultimately fails through thinning, and excessive thicknesses of paint are therefore not built up by successive repaints.
- (e) The dry film has practically no gloss, thus largely avoiding the loss of light by specular reflection.

DESIGN AND TESTING OF REFLECTIVE MATERIALS, SIGNS AND ROAD FURNITURE

A new section of the Materials Research Division has recently been established to assist in the design and testing of reflective signs, materials and road furniture. The work of the section will include:

- (a) the evaluation and development of materials and techniques for signing, delineating and surface marking of traffic ways;
- (b) the control of quality of materials supplied;
- (c) the testing of guard rail, frangible signposts, light poles and similar devices.

The work will entail the following operations:

- (a) the drawing up of specifications covering the supply of:
  - (i) reflective sheeting, retro-reflective and non-reflective pavement markers;
  - (ii) adhesives for binding the sheeting and markers to the pavement;
  - (iii) corner-cube reflectors and intersection marking materials, etc.
- (b) the development of test methods and apparatus;
- (c) the drafting of codes of practice covering the methods and precautions to be employed in the use of the materials.

Since a substantial part of the testing is concerned with the efficiency of retro-reflective devices, a photometric laboratory has been designed and established in the "dark tunnel" on the lower ground floor of the Board's Head Office building. The equipment installed or to be installed includes the following:

- (a) a controlled light source with a stabilized voltage electricity supply;
- (b) a device consisting of a battery of photo-voltaic cells arranged to sense the intensity of illumination at varying angles of divergence from the incident beam;
- (c) a digital voltmeter for measuring the output of the photo-voltaic cells;
- (d) mountings suitable for holding test specimens at predetermined distances from the source and at various angles to the light beam.

QUALITY CONTROL AT METROPOLITAN QUARRIES

The Board has fourteen Clerks of Works involved in plant control of quarry products for both direct control and municipal control work. The quantities of products supervised for the period 1/7/70 to 30/6/71 are as follows:

Material Type	Direct Control	Municipal Control		Total
		Board Subsidised	Sundry Debtor	
	Tons	Tons	Tons	Tons
Bituminous concrete	128,606	162,083	168,601	459,290
Wetmix, cement treated crushed rock, dry crushed rock	247,965	188,198	57,303	493,466
Cement concrete	5,410	472	—	5,882
	381,981	350,753	225,904	958,638



THE EFFECT OF CLIMATIC FACTORS ON BENKELMAN BEAM DEFLECTIONS

A long term programme to evaluate the effects of seasonal climatic variations on Benkelman beam deflections was initiated in March, 1969, jointly by the Board and the Australian Road Research Board.

Groups of sites within a radius of approximately sixty miles from Melbourne were selected in each of the following geological areas:

- Quaternary organic sand and clay deposits;
- Pliocene (newer) basalts;
- Oligocene (older) basalts;
- Devonian granites;
- Silurian sandstones and mudstones.

Within each area the sites were selected so as to have similar subgrade characteristics in order to minimize the effects, on deflections, of variations in subgrade type.

At each site, between 48 and 54 individual test spots were painted on the surface seal in six transverse rows at fifteen feet centres. The number of test spots therefore depended on the width of the seal. Deflection testing is carried out at each test spot at regular two-monthly intervals. Temperatures at the surface of the seal and at  $\frac{1}{2}$  in. below it are taken at each site during the test.

Mean seasonal deflections for spring (September-November), summer (December-February), autumn (March-May) and winter (June-August) have been calculated for the two years the investigation has been in progress. Rainfall figures for the areas under consideration show spring and autumn maxima, the former being the higher in all cases.

The test results are set out in Table 5. It was found that at ten of the twenty sites the spring mean deflection was higher than the other seasonal mean deflections. At one site the winter mean was highest and at the remaining ten sites the summer mean was highest. However, it is noteworthy that at *all* sites (except those on the older basalt), the differences between the highest seasonal mean deflection at any one site and the other seasonal mean deflections at that site are small (0.003 in. to 0.005 in.), compared with the difference between the highest and the other means at some older basalt sites (0.010 in. to 0.015 in.). These differences are indicated more clearly by the ratio of the spring mean to each of the other seasonal means for each site, as set out in Table 5.

The results show that in the selected older basalt areas, which have a comparatively high rainfall (over 40 in. per year) with a marked spring maximum, permeable subgrades and poor surface drainage, a correction factor as high as 1.4 could be appropriate if a Benkelman beam test is performed at the driest time of the year. The pattern is not as clear for other areas. It would seem at present that a factor of 1.1 would suffice for areas having a lower rainfall with a less marked seasonal maximum and/or relatively impermeable subgrades.

**TABLE 5—EFFECT OF CLIMATIC FACTORS ON BENKELMAN BEAM DEFLECTIONS**  
(Mean deflections in thousandths of an inch)

Geological Area	Site		Spring	Summer	Autumn	Winter
Quaternary organic sands and clays	PI	Means	45.2	46.8	43.1	42.6
		Ratio*		1.0	1.0	1.1
	PII	Means	52.7	54.5	49.8	49.6
		Ratio		1.0	1.1	1.1
Newer basalt	BI	Means	26.4	26.2	24.4	23.6
		Ratio		1.0	1.1	1.1
	BII	Means	61.6	60.0	54.8	51.5
		Ratio		1.0	1.1	1.2
	BIII	Means	53.2	58.3	52.3	44.1
		Ratio		0.9	1.0	1.2
	BIV	Means	43.1	39.9	38.7	39.8
		Ratio		1.1	1.1	1.1
Older basalt	RI	Means	51.7	43.4	38.9	42.4
		Ratio		1.2	1.3	1.2
	RII	Means	47.8	41.6	34.7	38.8
		Ratio		1.2	1.4	1.2
	RIII	Means	56.8	46.0	40.9	48.0
		Ratio		1.2	1.4	1.2
	RIV	Means	49.4	45.2	41.0	44.8
		Ratio		1.1	1.2	1.1

*continued*



Geological Area	Site		Spring	Summer	Autumn	Winter
Devonian granite	GI	Means	37.6	39.4	35.3	32.5
		Ratio		1.0	1.1	1.2
	GII	Means	28.8	28.7	25.1	27.7
		Ratio		1.0	1.1	1.0
	GIII	Means	21.8	21.1	18.9	20.7
		Ratio		1.0	1.2	1.1
	GIV	Means	36.6	33.8	31.9	33.8
		Ratio		1.0	1.1	1.1
Silurian sandstone and mudstone	SI	Means	17.3	17.5	16.8	17.1
		Ratio		1.0	1.0	1.0
	SII	Means	19.1	21.2	18.3	19.1
		Ratio		0.9	1.0	1.0
	SIII	Means	27.0	28.7	24.9	24.9
		Ratio		1.0	1.1	1.1
	SIV	Means	14.4	14.5	13.2	14.0
		Ratio		1.0	1.1	1.0
	SV	Means	17.4	17.2	17.0	17.7
		Ratio		1.0	1.0	1.0
	SVI	Means	37.2	34.5	32.6	34.3
		Ratio		1.1	1.1	1.1

$$*\text{Ratio} = \frac{\text{Spring mean deflection}}{\text{Summer, autumn or winter mean deflection}}$$

## SAND EQUIVALENT TESTS

An investigation was made into certain aspects of the Sand Equivalent (S.E.) test. The S.E. test is used by the Board as a rapid method for controlling the quality of deliveries of quarry products in regard to their proportions of plastic fines. The test is performed by taking a representative sample of the "passing  $\frac{3}{16}$  in." sieve fraction, treating and shaking this with a standard solution in a highly standardised fashion and allowing the mixture to settle. The S.E. value is the ratio of the height of the coarse grit to the height of the flocculate, expressed as a percentage. The higher the value, the better is the quality of the material.

The first matter investigated was the reproducibility of the test, which had given some difficulties. Two lots of material might serve equally well in roads but, of the two, the one which had stood in a wet stockpile would give the lower S.E. value because moisture had thoroughly penetrated the structure of the plastic fines and had left them capable of being more finely dispersed during the shaking. It was found that oven-drying the samples to a moisture free condition removed the influence of variable field moisture content.

The second aspect was in connection with the shaking technique. The use of a manually operated shaking device had been customary. A recently introduced California Highways Department machine-shaker removed the human element, and on testing was found to give more consistent results though the average S.E. values tended to be slightly lower because the shaking was a little more severe.

An extensive laboratory experiment was conducted to investigate the effects of oven-drying and machine-shaking on samples from various types of material. The results indicated that the increase in value from oven-drying and the reduction in value from machine-shaking were approximately equal in magnitude so that the simultaneous application of both modifications led to little change in average S.E. values.

For confirmation of the laboratory findings, all routine production samples (nearly 1,600) over a period of some months were tested by both the existing method and the proposed new method incorporating the two modifications. Detailed analysis of these results confirmed the earlier laboratory findings except for granitic materials, with which the proposed new method gave higher S.E. values. However, the higher values were considered to be satisfactory as the existing test was suspected of under-rating the quality of these materials.

In the course of the laboratory experiment an investigation was also made into the differences between S.E. values obtained from different samples taken from any lot of material submitted to the laboratory. The existing method included the performance of tests on duplicate sub-samples from a treated sample. As the results of the duplicate tests are always very little scattered if the testing is done correctly, the only practical value of testing the duplicate sub-samples is that a wide discrepancy indicates an error in testing. Duplicate sub-sample testing was applied throughout the experiment and confirmed the above indications. On the other hand, testing of various samples from any one lot of material gave widely scattered S.E. values. The conclusion reached was that the mean result of testing two separate samples from a lot gave a better representation of the S.E. value of that lot than did the testing of one sample twice. A further 76 production samples from several sources were tested and the results confirmed this conclusion.

The testing of two separate samples from each lot is considered to be very worthwhile as, with little extra effort, it leads to the possible difference between the observed mean test result and the intrinsic true result being about halved. When testing separate samples the function of preventing gross testing errors from going unnoticed is retained by increasing the allowable difference between the S.E. values from 2 points to 5 points on the scale 0-100.

The three changes, i.e. oven-drying, machine-shaking and the testing of two independent samples, have now been incorporated into the C.R.B. Standard Methods of Test. No Australian Standard Method exists as at 30th June, 1971, but the new method has been submitted to the Standards Association of Australia at the request of the Association.

### 3. ROADSIDE DEVELOPMENT

There is increasing public awareness of the importance of conservation and preservation of the natural environment. This results in a more critical examination by the public of the Board's road and bridge construction programme which must to a degree interfere, if only for a period of time, with the natural surroundings.

We can meet this problem with confidence, if we ensure that in planning our work landscapes are preserved as far as possible, and roadside areas are developed to achieve harmony between the road and the surrounding country. The highway engineer must have regard to the need for conservation of open space and natural beauty, to the planting or masking of construction scars, prevention of erosion and the provision of safe and attractive stopping places. All of these aspects are important in the overall task of road construction.

During 1970/71, the first issue of the Roadside Development Manual was produced, with the foregoing concepts in mind. Mr. J. R. Joyce, the Board's first Horticultural Officer, was largely responsible for the preparation of this manual which has stimulated great interest in this aspect of the Board's activities, both within and outside the Board's organization.

The programme of establishing toilet block facilities within rest areas was continued, with the completion of toilet blocks at Little River on the Princes Freeway in Geelong Division, and at Wood Wood on the Murray Valley Highway in Bendigo Division.

The largest tree planting scheme in progress during the year was on the Lower Yarra Freeway in Metropolitan Division, where approximately 12,000 trees and shrubs were established in interchange areas and along verges and the central median.

### 4. BITUMINOUS WORK

#### EXTENT OF WORK

The mileages of all types of bituminous surfacing completed during 1969/70 and 1970/71 are compared in Table 6. This shows that 3,250 miles were completed in 1970/71 compared with 3,300 miles in 1969/70, a decrease of about 1.5%.

The length of sealed pavements on the Board's declared road system was increased by 111 miles in 1970/71, and the length on unclassified roads was increased by 608 miles, as shown in Table 7.

Reconstruction of existing sealed pavements and restoration of the seal coat amounted to 383 miles of the declared road system, this length being 2.9% of the sealed length, compared with 3.3% in 1969/70 and 2.6% in 1968/69. Retreatments amounted to 1,142 miles or 8.7% of the sealed sections compared with 8.8% in 1969/70.

#### TYPES OF WORK

Sprayed work (initial treatments and retreatments) was again the main type of work amounting to 96.3% of the total length of work completed.

A length of 118 miles of plant mix work was completed during the year, that is, 3.7% of the bituminous surfacing programme, compared with 109 miles or 3.4% in 1969/70 (for further details see Table 7). For plant mix work completed during the year, a total of 264,073 tons of bituminous concrete was supplied and spread by contractors operating fixed plants near Melbourne, Geelong, Ballarat, Portland, Shepparton and Morwell.

#### COST OF WORK

The average unit cost of sprayed work completed by the Board's twenty bituminous surfacing units during the year is shown in Table 8. The average costs of sprayed work increased slightly compared with those for 1969/70, reflecting increased labour costs.

The average cost per ton of bituminous concrete supplied and spread during the year amounted to \$11.69 compared to \$10.85 for 1969/70.

Sprayed work accounted for 66% and plant mix work 34% of the total cost of the bituminous surfacing programme.

## MATERIALS

### (a) Aggregate.

A total quantity of approximately 309,000 cu. yd. of covering aggregate was used on sprayed work done by the Board's plant, 33,800 cu. yd. of aggregate was used on sprayed work done by municipalities and contractors and 200,000 cu. yd. of aggregate was used in bituminous concrete.

Table 9 sets out the average cost of aggregate over the past 5 years and shows that the 1970/71 average price remained the same as that for 1969/70.

### (b) Bitumen.

During 1970/71 the Board purchased directly 30,016 tons of bitumen which was distributed by road and rail by four marketing companies. All the bitumen used was produced from Kuwait crude petroleum oil.

Work commenced on the installation at Ballarat of two 8,000 gallon electrically heated bitumen tanks similar to those in operation at Benalla, Hamilton and Horsham. These tanks should be in operation for the 1971/72 season.

### (c) Primers.

The production of crude vertical retort tar primer in Victoria has been further reduced, resulting in larger quantities of special bitumen primers, petroleum tar primers and coke oven tar primers being used.

Petroleum tars of various grades produced in Sydney, N.S.W., have been used successfully for several years.

Coke oven tar primers are produced from high temperature coke oven tar from crudes produced during the manufacture of steel at Newcastle, N.S.W. Two grades equivalent to crude vertical retort tar and crude horizontal retort tar were used successfully throughout the 1970/71 season.

### (d) Experimental Work.

In the 1969/70 Report reference was made to experimental work to determine the efficiency of an antioxidant in bitumen.

This work was inspected after one year and a sample of the binder was taken from each section for laboratory examination.

At this early stage there is no apparent difference between sections or in the binders. Further inspections will be made and samples taken at yearly intervals.

**TABLE 6—BITUMINOUS SURFACING WORK COMPLETED**

Type of Road and Plant Used	1969/70	1970/71
	Miles	Miles
Work on roads to which the Board contributed funds:		
(a) C.R.B. declared roads:		
(i) Board's plant	1709	1627
(ii) Municipal plant	61	68
(iii) Contractors' plant	193	167
	1963	1862
(b) Undeclared roads:		
(i) Board's plant	1101	1126
(ii) Municipal plant	57	75
(iii) Contractors' plant	71	66
	1229	1267
Sub-totals	3192	3129
(c) Work done for other Authorities by the Board's plant (no Board contributions for these works)—		
(i) Municipalities	101	110
(ii) State Instrumentalities	7	10
(iii) Commonwealth works	—	1
	108	121
<b>Totals</b>	<b>3300</b>	<b>3250</b>

**TABLE 7—BITUMINOUS SURFACING WORK ON VARIOUS ROAD CATEGORIES**

(On roads to which the Board contributed funds during 1970/71)

Type of Work	State Highways	Freeways	Tourists' and Forest Roads	Main Roads	Total Board's Declared System	Unclassified Roads	Totals
	Miles	Miles	Miles	Miles	Miles	Miles	Miles
<b>Initial Treatments:</b>							
Extensions to sealed system—							
(a) Sprayed work	17.00	13.08	15.99	61.28	107.35	600.50	707.85
(b) Plant mix work	—	3.71	—	—	3.71	8.13	11.84
Reconstruction of lengths of previously sealed pavements—							
(a) Sprayed work	136.58	7.87	9.48	218.26	372.19	70.18	442.37
(b) Plant mix work	5.40	—	—	5.77	11.17	10.99	22.16
Widening of existing sealed pavements—							
(a) Sprayed work	32.65	9.53	5.90	135.16	183.24	55.00	238.24
(b) Plant mix work	0.60	—	—	5.15	5.75	0.75	6.50
Duplication of existing sealed pavements—							
(a) Sprayed work	17.46	5.20	—	0.90	23.56	0.70	24.26
(b) Plant mix work	5.38	2.30	—	5.69	13.37	1.83	15.20
<b>Retreatments:</b>							
(a) Sprayed work	399.10	20.20	34.44	639.11	1,092.85	505.72	1,598.57
(b) Plant mix work	21.46	8.09	1.67	18.09	49.31	12.54	61.85
<b>TOTALS</b>	<b>635.63</b>	<b>69.98</b>	<b>67.48</b>	<b>1,089.41</b>	<b>1,862.50</b>	<b>1,266.34</b>	<b>3,128.84</b>

**TABLE 8—AVERAGE COST OF SPRAYED BITUMINOUS SURFACING DONE BY C.R.B. PLANT**

(On roads to which the Board contributed funds during 1970/71)

(Cost in cents per square yard)

ITEM	NATURE OF WORK																			
	I.T.P. & S. ¾" & Over		I.T.P. & S. ½"		I.T.P. & S. ¾"		I.T.P. & S. ¼" & Sand		Primerseals		Two-Application Seal		I.T.S.O. and Reseals ¾" & Over		I.T.S.O. and Reseals ½"		I.T.S.O. and Reseals ¾"		I.T.S.O. and Reseals ¼" & Sand	
	63,367	2,577,809	1,893,219	205,493	1,765,471	109,945	39,245	5,288,518	8,057,225	8,134,087										
Square Yards Costed	cents	%	cents	%	cents	%	cents	%	cents	%	cents	%	cents	%	cents	%	cents	%	cents	%
Material	18.7	51.0	19.1	54.3	17.8	56.4	15.6	56.1	11.0	49.7	29.0	53.7	16.0	53.1	14.9	53.7	11.6	55.0	9.6	56.1
Stores	1.3	3.6	1.1	3.1	0.9	2.8	1.0	3.6	0.7	3.2	1.3	2.4	0.8	2.7	0.8	2.9	0.6	2.8	0.5	2.9
Plant Hire	6.4	17.5	6.2	17.6	5.4	17.1	4.7	16.9	4.2	19.0	10.3	19.1	5.0	16.6	4.7	17.0	3.5	16.6	2.9	17.0
Labour	10.2	27.9	8.8	25.0	7.5	23.7	6.5	23.4	6.2	28.1	13.4	24.8	8.3	27.6	7.3	26.4	5.4	25.6	4.1	24.0
<b>TOTALS</b>	<b>36.6</b>	<b>100.0</b>	<b>35.2</b>	<b>100.0</b>	<b>31.6</b>	<b>100.0</b>	<b>27.8</b>	<b>100.0</b>	<b>22.1</b>	<b>100.0</b>	<b>54.0</b>	<b>100.0</b>	<b>30.1</b>	<b>100.0</b>	<b>27.7</b>	<b>100.0</b>	<b>21.1</b>	<b>100.0</b>	<b>17.1</b>	<b>100.0</b>

I.T.P. & S. Indicates "Initial treatment prime & seal"  
I.T.S.O. Indicates "Initial treatment seal only"

**TABLE 9—AVERAGE PRICE OF AGGREGATE FOR BITUMINOUS SURFACING**

(In roadside stacks)

Material	Prices per cubic yard				
	1966/67	1967/68	1968/69	1969/70	1970/71
Screenings	\$ 5.04	\$ 5.19	\$ 5.01	\$ 5.12	\$ 5.08
Gravel	4.04	4.57	4.30	4.61	4.86
Sand	2.93	2.32	2.13	2.82	2.32
Scoria	2.90	2.80	2.93	2.90	3.30
Average price all aggregates	4.76	4.89	4.79	4.93	4.93

## ENGINEERING COMPUTER SECTION

### USE OF THE BOARD'S IBM 1620 COMPUTER DURING 1970/71

A summary of the use of the computer is set out in Table 10. Details of the work processed and programming work undertaken are contained elsewhere in this Report.

**TABLE 10—IBM 1620 USE, 1970/71**

User	Productive Hours	Developmental Hours	Total Hours
Accountant's Branch	13	—	13
Advance Planning Division	206	17	223
Asphalt Division	8	—	8
Bridge Sub-branch	521	158	679
Computer Section	272*	176	448
Major Projects Division	42	2	44
Materials Research Division	158	—	158
Mechanical Sub-branch	85	—	85
Outside Users	26	—	26
Planning Programme Division	20	1	21
Plans and Survey Division	569	43	612
Secretary's Branch	459	4	463
Title Survey Section	161	4	165
Traffic Engineering Division	220	43	263
Totals for 1970/71	2,760	448	3,208

\*Includes computer maintenance.

### USE OF EXTERNAL COMPUTER FACILITIES

A number of external computers were used during the year to utilise special facilities not available on the Board's computer and to relieve some of the heavy demand on it.

The computers used included those belonging to:

- C.S.I.R.O.—automatic plotting facilities;
- S.E.C.V.—automatic plotting and magnetic tape facilities;
- I.B.M. and C.D.C. Service Bureaux—road design and structural analysis;
- University of Melbourne—traffic assignment work;
- Monash University—contour mapping;
- Honeywell Timesharing Service—urgent road design work.

### TRENDS IN COMPUTER USE

Overall use of computers by Board staff was 12% higher in 1970/71 than in 1969/70. Use of the IBM 1620 increased by 4% and use of outside facilities increased by 60%.

A specification is being prepared for new computer equipment to replace the IBM 1620.

## SAFETY

There was a substantial reduction in the number of lost time injuries in 1970/71 compared with 1969/70. Details of the injuries are set out in Table 11.

**TABLE 11—INJURIES TO BOARD'S EMPLOYEES**

Type of Injury	1970/71	1969/70	Changes from 1969/70	
			Decrease	Increase
Back strains	57	50	—	7
Burns and scalds	14	29	15	—
Burns to eyes	8	13	5	—
Fatal injuries	1	0	—	1
Foreign bodies in eyes	29	42	13	—
Fractures	22	18	—	4
Head injuries	12	19	7	—
Lacerations and wounds	48	55	7	—
Miscellaneous	45	66	21	—
Multiple injuries	0	0	—	—
Occupational diseases	18	25	7	—
Sprains and strains	40	52	12	—
Totals	294	369	87	12

	1970/71	1969/70
Total man-hours worked	8,965,900	8,757,100
Lost time accidents	294	369
Accident Frequency Rate per million man-hours	32.7	42.1
Days lost	7,794	2,058
Days lost per million man-hours	869	235

The large increases in "days lost" and "days lost per million man-hours" from 1969/70 to 1970/71 were due to one fatal accident occurring in the latter year (each fatal accident is assessed as being equivalent to 6,000 days lost, in accordance with Australian Standard CZ6-1966, "Recording and Measuring Work Injury Experience"). In the fatal accident a man was killed by a road roller.

The Safety Officer made regular visits to regional Divisions, and the Central Workshop and Precasting Yard at Syndal. During the visits, inspections were made to detect existing and potential unsafe practices and conditions, following which remedial measures were discussed and recommendations were made to the engineers concerned.

The Board's Safety Programme was maintained through lectures to staff and employees, including addresses at induction sessions for new staff. Demonstrations on first aid and fire fighting were given.

Employees were encouraged to wear the most suitable types of safety footwear available for various working conditions. Investigations continued regarding the material used in orange-red jackets worn by traffic controlmen. It is desired to replace the existing plastic-coated fabric, which is impermeable to air, with a woven material.

Liaison continued with a number of external committees dealing with a variety of matters concerning safety.

## TRAINING

### INTERNAL TRAINING

A comprehensive in-service training programme was provided for officers of the Chief Engineer's Branch during 1970/71. Courses by selected officers were conducted on such subjects as materials test methods, road design, T.W.I. job instruction and job relations, computer applications and bituminous plant mix work.

With the growth of the Board's work, job management training has become increasingly important. A programme has been commenced to provide formal training on an inter-regional Divisional basis for the younger engineers who are involved in road construction supervision.

A considerable number of requests was received during the year for the Board to train Asian engineers and overseers who had been awarded Colombo Plan Fellowships. Appropriate training programmes were arranged for the Fellows to gain the required experience. Most of this training was given in the Board's regional Divisions.

The Young Engineers' Training Programme enabled a number of young engineers to gain experience in various Sub-branches and regional Divisions. The twelve months programme aims at giving younger engineers an overall appreciation of the Board's engineering work. Emphasis is placed on the engineers performing a useful function in the various areas during the programme.

#### EXTERNAL TRAINING

External courses were used to supplement the in-service training programme. Some of the more notable courses covered training in administration, construction management and traffic engineering.

#### ACADEMIC STUDIES

Several Board engineers are undertaking Master of Engineering Science Degrees in Soil, Structural or Transport Engineering at the University of Melbourne, and one is studying on a Board scholarship at the University of New South Wales, where he is undertaking studies in Highway Engineering for the Master of Engineering Science Degree.

A total of forty-seven Board cadets are at present undertaking studies at Universities and the Royal Melbourne Institute of Technology. Also, three young Board officers are completing their Diploma of Civil Engineering courses on a full time basis, having been awarded cadetships by the Board on the basis of successful part time studies and professional ability.

## PUBLICATIONS

The following papers were presented during 1970/71 in connection with the Board's engineering work:

Paper	Author
<i>Full Depth Bituminous Concrete Pavements, Part II</i> Published in Highway Engineering in Australia, July, 1971.	R. G. Allen, Dip.C.E., C.E., M.I.E.Aust.
<i>The Fracture Toughness of an Australian Universal Beam</i> Thesis submitted as partial fulfilment of the requirements for the Degree of Master of Engineering Science, University of Melbourne, 1970.	P. J. Balfe, B.E. (Civil)
<i>Full Depth Bituminous Concrete Pavements, Part I: Design, Materials and Economics</i> Published in Highway Engineering in Australia, June, 1971.	J. D. Bethune, Dip.C.E., C.E., M.I.E.Aust.
<i>Trends in Testing of Materials and Compaction Control</i> Published in Highway Engineering in Australia, November, 1970.	J. D. Bethune, Dip.C.E., C.E., M.I.E. Aust.
<i>The Measurement of Disturbance in Samples of Soft Clay</i> Presented to the Fourth Asian Regional Conference on Soil Mechanics and Foundation Engineering, Bangkok, 1971.	S. B. Bromham, B.Sc.
<i>An Analysis of Pile Loading Tests in a Stiff Clay</i> Presented to the First Australian and New Zealand Conference on Geomechanics, 1971.	S. B. Bromham, B.Sc.
<i>A Specification for Bituminous Concrete Aggregate</i> Presented to the First National Asphalt Conference, Sydney, Australia, February, 1971.	J. R. Styles, Dip.C.E., C.E., B.E. (Civil), Grad.I.E.Aust., Lecturer in C.E., Preston Institute of Technology
<i>Current Specifications for Compaction in Victoria</i> Presented to an Australian Road Research Board Symposium, Lismore, N.S.W., May, 1971.	D. T. Currie, Ph.D., B.C.E., M.I.E.Aust.
<i>Skid Resistance of Road Surfaces</i> Published in Highway Engineering in Australia, May, 1971.	D. T. Currie, Ph.D., B.C.E., M.I.E.Aust.
<i>An Evaluation of the Luminance Contrast Requirements of Highway Signs</i> Presented to the Fifth Biennial Conference of the Australian Road Research Board, Canberra, September, 1970.	K. D. Freeman, F.R.M.I.T., C.T.P.C., M.I.E.Aust.
<i>Some Examples of the Design and Operation of Urban Intersections</i> Presented to the Highways and Traffic Engineering Branch of the Victorian Division of the Institution of Engineers, Australia, May, 1971.	B. L. Hills, Ph.D. Research Officer, A.R.R.B. A. T. Fry, B.E. (Civil), M.Eng.Sc., M.I.E.Aust.
<i>Provincial Urban Transportation Studies</i> Presented to the Transportation and Highways Branch of the Victorian Division of the Institution of Engineers, Australia, June, 1971.	N. S. Guerin, B.C.E., C.E., Cert.H.T. (Yale), M.I.E.Aust., A.M.I.T.E.
<i>Shear Lag in Box Girder Bridges</i> Thesis submitted as partial fulfilment of the requirements for the Degree of Master of Engineering Science, University of Melbourne, March, 1971.	R. C. Meggs, Dip.C.E., B.E. (Civil), M.I.E.Aust.



Paper	Author
<i>Some Aspects of the Construction of the Roadworks of the Western Approaches to the Lower Yarra Crossing</i> Published as C.R.B. Technical Report No. 52.	R. N. Morison, B.Sc., C.Eng., C.E., A.M.I.C.E., M.I.E.Aust.
<i>Some Aspects of the Investigation, Survey and Design of the Lower Yarra Crossing Approaches (West Gate Bridge Approaches)</i> Presented to the Highways and Traffic Engineering Branch of the Victorian Division of The Institution of Engineers, Australia, March, 1971.	R. N. Morison, B.Sc., C.Eng., C.E., A.M.I.C.E., M.I.E.Aust. S. C. B. Eriksson, B.Sc.(Eng.), M.Eng.Sc., A.M.(S.A.)I.C.E., M.I.E.Aust.
<i>Highway Planning and Community Values</i> Presented to the Highways and Traffic Engineering Branch of the Victorian Division of The Institution of Engineers, Australia, October, 1970.	D. Pritchard, Dip.C.E., C.E., M.S.C.E., M.I.E.Aust.
<i>Highway Engineering in Victoria During the 70s</i> Published in MEMO No. 3, April, 1971.	T. H. Russell, M.Eng.Sc., B.C.E., Dip.C.E., C.E., F.I.E.Aust.
<i>Laboratory Behaviour of Cement-Stabilized Pavement Materials</i> Presented at the Fifth Biennial Conference of the Australian Road Research Board, Canberra, September, 1970.	R. H. Solly, B.E. J. R. Morgan, B.C.E., Ph.D., M.I.E.Aust., Reader C.E., University of Melbourne
<i>Repeated Loads on Cement-Stabilized Sand</i> Presented at the Fifth Biennial Conference of the Australian Road Research Board, Canberra, September, 1970.	A. F. Williams, B.E., M.Eng.Sc., Grad.I.E.Aust. J. R. Morgan, B.C.E., Ph.D., M.I.E.Aust., Reader C.E., University of Melbourne
<i>Permeability of Granular Materials</i> Published in Australian Road Research, Vol. 4, No. 5, September, 1970.	A. K. Parkin, B.E., M.Eng.Sc., Ph.D., M.I.E.Aust., A.M.A.S.C.E., Research Fellow, University of Melbourne K. I. York, A.R.M.I.T. (Applied Physics)

Five issues of Engineering Notes were published as follows:

- No. 93, "Skid Resistance of Road Surfaces."
- No. 94, "Assessment of Some Experimental Sections of Rural Roads by the Australian Road Research Board."
- No. 95, "Use of Scoria-Tuff as a Road Base Material."
- No. 96, "Windscreen Breakages Due to Projection of Stones by Motor Vehicles."
- No. 97, "Setting Out Work and Checking Quantities."

The following Technical Reports were published:

- No. 52, "Some Aspects of the Construction of the Roadworks for the Western Approaches to the Lower Yarra Crossing."
- No. 53, "A Note on the Question, 'Does Marram Grass Benefit by Being Pruned Before it is Planted?'"
- No. 54, "Testing of Slip Bases for Light Poles for Freeways."
- No. 55 "The Upgrading of a Road Base Material Using Foamed Bitumen as a Stabilizing Agent."

## TECHNICAL LIBRARY

The Technical Library continued to provide an information service to Head Office and regional Divisional staff.

Six bi-monthly library accession lists were issued during the year, listing 1,160 new books, reports and standards. Sixteen new periodical titles were added, making a total of 370 periodicals received by the Library, either by subscription, through membership to twenty-five organizations, or on a complimentary basis.

Approximately 400 items were borrowed each month from the Library and periodicals were circulated regularly to 280 staff members. Inter-library loan facilities played an important part in the provision of information.

A Geodex information retrieval system was added to the Library during 1970/71. Based on a co-ordinate indexing concept, it covers the subjects of structural engineering and mechanics, bridge engineering and related civil engineering fields.

## STAFF

At 30th June, 1971, the total staff of the Chief Engineer's Branch was 1,207.

During 1970/71 Mr. L. Upton retired as Divisional Engineer—Ballarat, due to ill-health, after almost 31 years' service with the Board, and Mr. T. C. Lester retired as Principal Title Survey Officer after more than 20 years' service. These officers made valuable contributions to the Board's activities during their service.

The total cost of work performed in 1970/71 by the Board on its own direct works and for other authorities, and by municipalities with funds made available by the Board, was \$85,569,000.

I extend my thanks to the staff for their loyalty and industry in contending with the Board's increasingly large and complex activities.

T. H. RUSSELL, M.Eng.Sc., B.C.E., Dip.C.E., C.E., F.I.E.Aust.  
Chief Engineer