

1967-68

VICTORIA

COUNTRY ROADS BOARD

FIFTY-FOURTH
ANNUAL REPORT

FOR YEAR ENDED 30TH JUNE, 1967

PRESENTED TO BOTH HOUSES OF PARLIAMENT PURSUANT TO ACT No. 6229.

By Authority:

A. C. BROOKS, GOVERNMENT PRINTER, MELBOURNE.

COUNTRY ROADS BOARD

Chairman **I. J. O'Donnell**
Deputy Chairman **R. E. V. Donaldson**
Member **F. West**

PRINCIPAL OFFICERS

HEAD OFFICE

Chief Engineer **H. S. Gibbs**
Deputy Chief Engineer **H. P. George**

DEPUTY CHIEF ENGINEERS

<i>Works</i>	<i>Road Design</i>	<i>Bridges</i>	<i>Mechanical</i>
C. C. Perrin	J. H. Townley	B. R. Abery	G. M. Langham

Secretary **N. L. Allanson**
Deputy Secretary **C. C. Liddell**
Accountant **R. G. Cooper**
Deputy Accountant **R. J. C. Bulman**

DIVISIONAL OFFICES

<i>Division</i>	<i>Divisional Engineer</i>
Bairnsdale	W. H. Dolamore
Ballarat	F. F. O'Brien
Benalla	R. C. Handley
Bendigo	L. Upton
Dandenong	F. W. Docking
Geelong	W. F. Neville
Horsham	A. J. Pryor
Metropolitan	H. W. P. Hobbs
Traralgon	A. Jacka
Warrnambool	F. G. Lodge

60 Denmark Street,
Kew.
12th January 1968

*The Honourable M. V. Porter, M.L.A.,
Minister of Public Works
State Public Offices,
Melbourne 3000*

Sir,

In accordance with the requirements of Section 128 of the Country Roads Act 1958, No. 6229, the Board has the honour to submit to you for presentation to Parliament the report of its proceedings for the year ended 30th June, 1967.

The Board thanks you, Sir, for your continued support and interest in its activities and wishes to place on record its appreciation of the continued co-operation and assistance of other State Ministers, Government Departments, State instrumentalities and municipal councils.

The Board also pays tribute to the continued loyal co-operation and work done by its staff and employees throughout the year.

We have the honour to be,

Sir,

Your obedient servants

I. J. O'DONNELL, O.B.E., E.D., B.C.E.,
M.I.E. Aust., F.A.I.M., Chairman

R. E. V. DONALDSON, A.A.S.A. (-Senior),
J.P., Deputy Chairman

F. WEST, B.C.E., M.I.E. Aust.,
C.E., Member

N. L. ALLANSON, A.A.S.A. (-Senior), J.P.,
Secretary

COUNTRY ROADS BOARD

FIFTY-FOURTH ANNUAL REPORT, 1966-67

CONTENTS

	Page
Review	1
Finance—	
(i) Receipts	6
(ii) Expenditure	7
(iii) Sharing the cost of roadworks	7
Road Needs Survey	8
Road Construction and Maintenance—	
(i) Declared road system	8
(ii) State highways	8
(iii) By-pass roads	8
(iv) Tourists' roads	11
(v) Forest roads	11
(vi) Main roads	11
(vii) Unclassified roads	11
(viii) Contracts	12
(ix) Bituminous surfacing	13
(x) Line marking	13
(xi) Princes Highway East	13
(xii) Snow clearing in the Alps	15
Roadside development	17
Bridges	18
New Divisional Office, Ballarat	21
Flood Damage	21
Works carried out on behalf of or in conjunction with other Authorities—	
(i) Tourist Development Authority	22
(ii) National Parks Authority	22
(iii) Rural Finance and Settlement Commission	23
(iv) Railway Department—Elimination of railway level crossings	23
(v) State Rivers and Water Supply Commission	24
Road Materials and Research	24
Control of Heavy Traffic	25
Legislation affecting the Board	25
Films and Displays	26
Conferences—	
(i) Municipal Engineers	27
(ii) Municipal Associations	28
Municipal Inspections and Deputations	28
National Association of Australian State Road Authorities	28
Australian Road Research Board	29
Personnel—	
(i) Recruitment and retirements	30
(ii) Industrial relations	31
(iii) Secondments and National Service	31
(iv) Training	31
(v) Cadetships	32
Appendix 1 State Highways	33
Appendix 2 {Tourists' Roads	
{Forest Roads	43
Appendix 3 Main Roads	45
Appendix 4 Unclassified Roads	53
Appendix 5 Motor Registration	54
Appendix 6 Statement of Receipts and Payments for year ended 30th June, 1967	55
Appendix 7 Loan Liability as at 30th June 1967	56
Appendix 8 Works executed on behalf of Commonwealth and Victorian State Government Authorities	56
Appendix 9 Chief Engineer's Report	57

ANNUAL REPORT, 1966/67

REVIEW

At 30th June 1967, motor vehicle registrations in Victoria totalled 1,221,352. Five years ago the figure was 876,633 and there is every indication that the next five years will produce a similar increase. These figures alone illustrate the huge task confronting road construction authorities in attempting to meet the needs of modern traffic both now and in the future. They also illustrate the growing dependence that Victorians are placing on the motor vehicle as a means of personal travel and business transport.

While it is true that the Board's funds have increased from \$48,085,738 in financial year 1961/62 to \$65,484,982 in 1966/67, Victoria is still not receiving a just return from the amounts paid to the Commonwealth by Victorians in the form of petrol tax. Whatever the arguments might be for paying all forms of Commonwealth taxation into Consolidated Revenue instead of devoting the proceeds of particular taxes to particular purposes, the facts are that there is a definite relationship between the petrol consumption by road vehicles and actual road usage. It is most inequitable that in financial year 1966/67 Victorian motorists paid approximately \$70 million in petrol tax and in return Victoria received only \$29,050,089 from the Commonwealth for expenditure on roads.

Additional funds from the Commonwealth would mean an acceleration in the programme of construction of dual carriageways, elimination of railway level crossings and many other road safety improvements to Victoria's principal road network.

A further improvement in the rate of construction would be possible if the heavy commitment to the acquisition of land for roads were charged to loan funds instead of revenue. During the year approximately \$4.7 million was spent on land acquisition. Much of this undoubted capital expenditure was incurred in respect of future by-pass roads which will not benefit the public for some years. It would be just and equitable if this heavy burden could be borne by loan funds and thus shared with posterity for whose benefit it is being incurred.

In addition to \$64,264,716 spent from its own funds the Board expended \$3,310,762 on behalf of the Government from the Roads (Special Projects) Fund, during the year.

This total expenditure of \$67,575,478 enabled the Board to

- (a) construct 30.6 miles of additional dual carriageways;
- (b) construct 175 new bridges;
- (c) eliminate in conjunction with the Victorian Railways four railway level crossings by the construction of road overpasses or underpasses;
- (d) seal or reseal with bitumen 3214 miles of road;
- (e) purchase land valued at \$4,650,00 for future new roads, deviations and widening of existing roads;
- (f) generally improve, widen and maintain 14,499 miles of the principal road system of the State, together with approximately 20,000 miles of unclassified roads;
- (g) plant 45,000 trees and shrubs on State highways and by-pass roads;
- (h) establish wayside stops adjacent to State highways for the benefit of the travelling public

ROAD (SPECIAL PROJECTS) FUND

Many of the works financed from the Roads (Special Projects) Fund involve the construction of dual carriageways. Prior to the enactment of the Roads (Special Projects) Act 1965 the Board was constructing new dual carriageways at the rate of 18 miles each year. In 1966/67 the rate of construction increased to 31 miles per year and this will increase progressively as more funds become available.

Dual carriageways completed during the year financed from the Roads (Special Projects) Fund were:

- SPECIAL PROJECT No. 2—Hume Highway—
4·4 miles between Craigieburn and Kalkallo
- SPECIAL PROJECT No. 5—Western Highway—
7 miles between Deer Park and Rockbank
- SPECIAL PROJECT No. 6—Princes Highway East—
2 miles between Doveton and Hallam
- SPECIAL PROJECT No. 7—Western Highway—
1·75 miles on the eastern approach to Pykes Creek reservoir
- SPECIAL PROJECT No. 8—Hume Highway—
2 miles north and South of Tallarook
- SPECIAL PROJECT No. 13—Nepean Highway—
2·1 miles between Frankson and Mt Eliza

Other works which were financed from the Roads (Special Projects) Fund and opened to traffic during the year were:

- SPECIAL PROJECT No. 10—Princes Highway East—
5·5 miles of two-lane roadway including a new bridge at Hospital Creek near Orbost
- SPECIAL PROJECT No. 12—Taylor Bay Road—
4·4 miles of new road for tourists between Taylors Lane and Haines Saddle overlooking Lake Eildon
- SPECIAL PROJECT No. 14—Marlo - Cape Conran Road—
7·7 miles of two lane road for tourists between Marlo and Cape Conran in the Shire of Orbost



Special Road Fund Project No. 13—Dual carriageways on the Nepean Highway South of Frankston.

OTHER WORKS THROUGHOUT THE STATE

Some of the major works financed from the Board's funds completed or in progress during the year included:

PRINCES HIGHWAY WEST—Reconstruction in Footscray City to provide dual carriageways between Robbs Road and Somerville Road, a distance of 0·6 miles.

PRINCES HIGHWAY WEST—Widening the bridge over the Barwon River in Geelong to provide for four traffic lanes.

PRINCES HIGHWAY EAST—Construction of 1·6 miles of dual carriageways between Morwell and Morwell East.

WESTERN HIGHWAY—Construction of 1·1 miles of dual carriageways from Kororoit Creek to Deer Park.

HUME HIGHWAY—Completion of four bridges over the Goulburn River as part of the new southern approach to Seymour.

HUME HIGHWAY—Construction of 1·1 miles of dual carriageways in Seymour township.

BURWOOD HIGHWAY—Construction of four traffic lanes without a median strip between Warrigal Road and Edwards Street, Box Hill.

OMEIO HIGHWAY—Reconstruction and realignment of 2 miles between Gibson's deviation and Black Camp Creek south of Omeo.

CANTERBURY ROAD—Extension of dual carriageways and intersection treatment at Springvale Road, City of Nunawading for a distance of 0·5 mile.

Details of further significant works completed on State highways, bypass roads, tourists roads, forest roads and unclassified roads, throughout the State are listed in Appendices.



*Dual carriageways and intersection treatment at the junction of Canterbury Road and Springvale Road
—Nunawading City.*

TULLAMARINE FREEWAY

The section of Tullamarine Freeway for which the Board is responsible extends from Bell Street, Coburg along the route of the proposed Strathmore By-pass Road to the southern boundary of the Essendon Airport and thence from the north-west corner of that airport northerly for approximately four miles to the entrance to the new Melbourne Airport (Tullamarine).

Progress during the year on the section north of the Essendon Airport continued to be good and is expected to be completed towards the end of calendar year 1967. This four-mile section is of dual carriageway construction with fully controlled access and grade separated intersections and contains 12 bridges.

The Strathmore By-pass Road section of the freeway is expected to be under construction next financial year. Most of the land required for this road has already been acquired. The road will be approximately 2 miles long and will include eight interchange structures. At its eastern end over the Moonee Ponds Creek, two separate levels of roadway will be constructed above the Broadmeadows railway line.

PEDESTRIAN OVERPASSES

During the year a pedestrian overpass was constructed over the Western Highway in the City of Sunshine, adjacent to the Braybrook State School. This was the first overpass completed under the scheme sponsored by the Government for the erection of such crossings to enable school children to cross busy State highways in safety.

Work also proceeded on the construction of an overpass over the Western Highway near the Braybrook High School. Good progress was achieved with the necessary planning, land resumption and design work for the construction of overpasses in the following localities:

Nepean Highway in Moorabbin City, near the Moorabbin State School.

Maroondah Highway in Blackburn, near the Blackburn School.

Maroondah Highway in Mitcham near St. John's R.C. School.

Princes Highway in Kingsville near the Kingsville State School and the Footscray Corpus Christi Denominational School.

C.R.B. NEWS

In November, 1966, the Board published the first edition of C.R.B. News. Further editions were published just prior to the Christmas holidays and in March, 1967.

C.R.B. News is providing a valuable means of communication with all sections of the public by publishing information about the Board's current and proposed works programmes.

LITTER

The Board has noted with concern the increasing amount of litter left on roadsides. The litter is an appalling eyesore and a possible health hazard. The necessary disposal of litter also diverts the Board's road patrolmen from their main task of caring for and maintaining the roads.

In an endeavour to encourage people to be tidy the Board is providing litter bins at all of its parking bays, roadside fire-places, scenic lookouts and rest areas. The Board intends to take every opportunity to draw the attention of the public to the need to eliminate litter from roadsides.

LOWER YARRA CROSSING

In February 1966, the Board was appointed as the design and constructing authority for the access roads to the bridge in the Lower Yarra Crossing Project. These access roads will provide a freeway type connection between the Princes Highway West near Kororoit Creek and the interchange with the bridge approach at Williamstown Road west of the river and connections with existing roads at the Graham Street interchange east of the river in Port Melbourne City. At a later date connections are planned to the proposed city ring road, the South Eastern Freeway and the Princes Highway East.

A special Government Committee appointed in 1964 estimated that the usage of the toll crossing over the Lower Yarra would be 30,000 vehicles per day at its completion in 1971 and recommended that a high level bridge having six traffic lanes should be constructed.

The State Government passed legislation constituting the Lower Yarra Crossing Authority and giving it the power to construct and operate a toll bridge. A bridge having eight traffic lanes will be constructed to meet an estimated increase in traffic to 68,000 vehicles per day in 1985.

In June 1967 the Board was authorized to commence negotiations for the purchase of 114 house properties and 15 vacant housing blocks which are required for the western approaches to the bridge.



Princes Highway West—Dual carriageways between Robbs Road and Somerville Road—Footscray City.



Princes Highway East—Dual carriageways at the McDonald Street intersection in Morwell.

FINANCE

The total amount available to the Board for expenditure on its normal road programme during the year was \$66,564,514, including a balance of \$1,079,532 carried forward from financial year 1965/66. In addition the Board expended on behalf of the Government an amount of \$3,310,762 from the Roads (Special Projects) Fund.

RECEIPTS

Total receipts for the financial year 1966/67 compared with those of financial year 1965/66 are shown below:

STATE SOURCES	1965/66	1966/67
Motor Car Act	\$24,690,230	\$25,871,489
Commercial Goods Vehicles Act (Ton mile tax)	6,378,508	6,732,313
Municipalities' repayments	1,691,398	1,823,958
Loan Funds	1,019,600	833,520
Special Grant from State Treasury	768,000	714,920
General Receipts	470,893	458,693
	<u>\$35,018,629</u>	<u>\$36,434,893</u>
<hr/>		
COMMONWEALTH AID ROADS ACT		
General purposes	\$16,172,093	\$17,273,026
Rural Roads	11,003,090	11,777,063
	<u>27,175,183</u>	<u>29,050,089</u>
Grand Total	<u>\$62,193,812</u>	<u>\$65,484,982</u>

EXPENDITURE

Expenditure in the form of cash payments during the financial year 1966/67 amounted to \$64,264,716 leaving a balance of \$2,299,798 to be carried forward into financial year 1967/68. The receipts under the Commonwealth Aid Roads Act were fully expended leaving the balance of funds in the Country Roads Board Fund.

The following table compares expenditure in 1966/67 with 1965/66:

Item	1965/66	1966/67
Construction and maintenance of roads and bridges	\$51,660,383	\$54,443,968
Capital expenditure, e.g. plant, workshops, offices &c.	1,582,506	1,553,520
Salaries, operating accounts and other administration expenditure	4,482,626	5,074,487
Statutory payments to Tourist Fund, Transport Regulation Fund and refund of Special Advance &c.	1,341,884	1,052,280
Interest and Sinking Fund payments	2,056,328	2,140,461
	<u>\$61,123,727</u>	<u>\$64,264,716</u>

SHARING COSTS

The Country Roads Act provides that no more than one-half of the amount expended on permanent works and one third of the amount expended from the Country Roads Board Fund on main roads during the preceding financial year shall be apportioned between the various municipalities benefited thereby. The Act also provides that the amount apportioned to a council in respect of expenditure charged to the Country Roads Board Fund may be reduced where the cost of maintenance is excessive due to motor traffic not of local origin or to timber traffic. The revenue, valuation and rating of the municipality and its financial obligations for loan expenditure on permanent works are taken into account in deciding the level of contribution by a council.

In September 1966, expenditure on main roads in financial year 1965/66 was apportioned in accordance with the Country Roads Act resulting in the following distribution of expenditure:

Expenditure from Country Roads Board Fund	\$10,316,704
Expenditure from Commonwealth Aid Road moneys	3,569,387
Expenditure from proceeds of ton mile tax (Commercial Goods Vehicles Act)	2,133,806
TOTAL	<u>\$16,019,897</u>
Amount apportioned to councils	<u>1,733,282</u>

Municipal councils were therefore required to bear only 10·8% of the total expenditure on main roads. The previous year's contributions by municipal councils amounted to 10·91% of the total expenditure on main roads.

Within the limits of funds available the Board made allocations to municipal councils for works on unclassified roads. The expenditure incurred from the allocations made by the Board in financial year 1966/67 compared with 1965/66 was as follows:

	1965/66		1966/67	
	C.R.B.	Council Contribution	C.R.B.	Council Contribution
Construction &c.	\$11,174,704	\$3,254,149	\$10,956,264	\$2,854,840
Patrol Maintenance	1,515,946	680,076	1,520,781	693,282
TOTALS	<u>\$12,690,650</u>	<u>\$3,934,225</u>	<u>\$12,477,045</u>	<u>\$3,548,122</u>

ROAD NEEDS SURVEY

The National Association of Australian State Road Authorities of which the Board is a member has from time to time produced Road Needs Surveys with the object of making a realistic assessment of the investment needed over the subsequent decade to provide an adequate road system. The method used has been based on an analysis of existing roads and the traffic using them, a projection of increasing traffic and the changing traffic patterns followed by an estimate of the cost of constructing roads of a reasonable standard to meet the need. The difference between forecast receipts and the need in monetary terms has been revealed as the deficiency in road funds.

The Commonwealth Bureau of Roads, created by the Commonwealth Government in 1964 decided that a comprehensive Australia-wide road needs survey would be required by it in connection with its function to advise the Commonwealth Government through the Minister prior to the expiry of the current Commonwealth Aid Roads Act in 1969. The National Association of Australian State Road Authorities had independently been planning for its periodic 10-year study for the decade 1969/79 and following negotiations, the two bodies agreed to plan jointly and conduct a study for the two five year periods commencing 1st July 1969. Agreement was reached on basic assumptions and premises, and the general specification prepared by a sub-committee of the Advance Planning Committee of NAASRA was approved by NAASRA. The Commonwealth Bureau of Roads produced guide lines for the conduct of investigations in capital city areas, and organized a briefing at the Board's Head Office of representatives of all the Authorities in the techniques and procedures desired.

It is intended that the results of the survey will be available in 1968. This will permit consideration of the results before the Commonwealth Government formulates the provisions of the next Commonwealth Aid Roads Act, the present Act expiring on 30th June 1969.

ROAD CONSTRUCTION AND MAINTENANCE

DECLARED ROAD SYSTEM

The mileage of declared roads at 30th June, 1967 totalled 14,499 miles which included 4460 miles of State Highways, 40 miles of by-pass roads, 445 miles of tourists' roads, 461 miles of forest roads and 9093 miles of main roads.

Despite the many requests the Board received during the year for roads to be declared under the Country Roads Act, the Board was not in a sufficiently assured financial position to increase the length of its declared road system because of the large commitments arising out of the existing declared roads.

STATE HIGHWAYS

The Board's expenditure on State highways during the year was \$19,670,997 including \$2,515,787 from the Roads (Special Projects) Fund. Included in the former total, maintenance of existing road assets cost \$4,689,407 which is 23·8 per cent of the total.

In addition to the major works referred to on page 1 of this report, there were many other improvements in the form of realignments, widening of sealed pavements, regrading and reshooting carried out during the year. Details of the more significant of these works are listed in Appendix 1.

BY-PASS ROADS

The declared by-pass roads at 30th June, 1967 were:

Princes By-pass Road (Laverton Section)	7·87 miles
Maltby By-pass Road	6·67 „
Whitelaw By-pass Road	2·36 „
Hume By-pass Road (Chiltern-Barnawartha Section)	13·21 „
Hume By-pass Road (Craigieburn Section)	1·54 „
Frankston By-pass Road	2·07 „
Princes By-pass Road (Haunted Hills Section)	2·72 „
Princes By-pass Road (Morwell Section)	3·75 „

The major construction expenditure during the year was incurred on the Tullamarine By-pass Road and the Princes By-pass Road (Moe Section). As in previous years, expenditure was also incurred in the purchase of land for future by-pass roads.

\$2,695,000 was expended on purchasing land for the following future projects:

Healesville Freeway By-pass Road
Mulgrave By-pass Road
Scoresby By-pass Road
Strathmore By-pass Road
Frankston By-pass Road
Mornington Peninsula By-pass Road
Dingley By-pass Road

Greensborough By-pass Road
Calder By-pass Road
Cranbourne By-pass Road
Eumemmerring By-pass Road
Latrobe Valley By-pass Road
Tullamarine By-pass Road
Tourists' Roads

STATE HIGHWAY



Calder Highway—Reconstruction with an additional climbing lane at Taradale.

MAIN ROAD



Yarram-Traralgon Road—Reconstructed section near Lays Road—Shire of Alberton.



WALHALLA FOREST ROAD

*Typical narrow section south
of the Aberfeldy River be-
fore reconstruction.*



*Construction work in prog-
ress.*



*Widening of road formation
near completion.*

TOURISTS' ROADS

The Board's expenditure on tourists' roads during the year was \$2,311,522.

The developing tourist industry in the State is an important factor in the increase in traffic on roads of tourist interest. Tourists' roads proclaimed under the Country Roads Act are maintained by the Board to provide access to places of special attraction to tourists in both summer and winter. At 30th June, 1967 there were 20 separate proclaimed tourists' roads in the State totalling 445 miles.

Details of the more significant works carried out on tourists' roads are listed in Appendix 2.

FOREST ROADS

At 30th June, 1967, there were 24 separate proclaimed forest roads in the State totalling 461 miles.

The Board's expenditure on forest roads during the year was \$737,086.

Details of the more significant works completed on forest roads are listed in Appendix 2.

MAIN ROADS

At 30th June, 1967, there were 667 separate declared main roads in the State totalling 9093 miles.

Main roads are roads linking centres of population with other centres or with areas of settlement. As a general rule main roads are constructed and maintained by municipal councils to the satisfaction of the Board, except in some cases, to assist the Council concerned, the Board undertakes this work with the approval of the Governor in Council.

Once again the Board was unable to allocate sufficient funds to satisfy applications for funds from municipal councils; the following table shows the applications, allocations and expenditure on main roads in financial years 1965/66 and 1966/67.

	1965/66	1966/67
	\$'000s	\$'000s
A Applications	31,091	31,664
B Allocations	22,129	22,243
C Expenditure	16,569	16,765
	%	%
B as percentage of A	71.2	70.2
C as percentage of B	74.9	75.4

A summary of the more important works completed on main roads during the year is contained in Appendix 3.

UNCLASSIFIED ROADS

The Board assists municipal councils financially to carry out construction and maintenance works on selected unclassified roads under their care and management. A total of \$12,477,000 was expended by the Board on approximately 20,000 miles of unclassified roads. The applications for funds for construction and maintenance works, together with allocations made and expenditure incurred, are shown in the table below.

	1965/66	1966/67
	\$'000s	\$'000s
A Applications	37,709	39,943
B Allocations	16,254	16,871
C Expenditure	12,691	12,477
	%	%
B as percentage of A	43.1	42.2
C as percentage of B	78.1	74.0

A list of the more significant unclassified roadworks is contained in Appendix 4.

CONTRACTS UNDER BOARD'S DIRECT SUPERVISION

The categories of new contracts entered into by the Board during the year and their respective values are shown in the following table:

Category of Contract	Number of Contracts	Value
Road construction (Major works, i.e. over \$60,000)	12	\$3,286,908
Road construction (Minor works, i.e. under \$60,000)	18	454,041
Supply of roadmaking materials	93	1,862,236
Bituminous treatment and supply of materials	109	3,176,225
Bridge construction	25	1,234,423
Manufacture of bridge components and fabricated steel	16	274,899
Supply of reinforced concrete pipes and box culverts	20	660,000
Supply of road and bridge construction equipment	41	1,345,875
Divisional facilities	12	151,525
Fuel, tyres and tubes, stores and other services	18	775,997
Totals	364	\$13,222,129

As at 30th June, 1967 the value of the outstanding work involved in road and bridge construction contracts was \$4,040,000 including \$202,000 of contract works being financed from the Roads (Special Projects) Fund.

In general the Board received competitive tenders at realistic prices for all categories of work.

CONTRACTS UNDER COUNCILS' SUPERVISION

During the year the Board approved the acceptance by municipal councils of 486 tenders for a total amount of \$6,432,730 for road and bridge works for which the Board allocated funds in whole or in part.

Approval was also given to the use of 100 municipal period contracts for the supply of materials for works partly financed from funds provided by the Board.



Completing the bituminous sealed pavement between Melbourne and Sydney on the Princes Highway East near Mount Drummer.

BITUMINOUS SURFACING

The Board's 24 mobile bituminous surfacing units and one mobile asphalt plant, together with plant owned by municipal councils and contractors carried out sealing work on 3214 miles of public roads during the year.

The work included:

308 miles of widening existing pavement
38 miles of duplicated carriageways
504 miles of restoration of seal coats on reconstructed sections
1408 miles of maintenance retreatment.

The mileage of bituminous sealed public roads throughout the State was extended by 836 miles as follows:

State highways and by-pass roads	18
Tourists' roads and forest roads	16
Main Roads	107
Unclassified roads	695
	<hr/>
TOTAL	836 miles

159,272 tons of bituminous concrete was used on 94 miles of the more densely trafficked roads. The major portion of plant mix work was undertaken by contractors operating fixed asphalt plant.

The Board purchased 30,418 tons of bitumen, of which approximately 70 per cent was carried by rail. The Board also purchased approximately 13,000 tons of bituminous materials such as cut back bitumen, tars and emulsions.

The total length of sealed roads on the Board's declared road network is 12,713 miles or 87.6 per cent of the total length of declared roads.

LINE MARKING

The Board maintained traffic line marking on 5707 miles of road consisting of 3735 miles of State highways, 1678 miles of other declared roads and 294 miles of unclassified roads. Of the total mileage 49 per cent was reflectorized with glass beads.

The total mileage of equivalent standard 3 inch line painted during the year was 15,036 compared with 13,115 last year. Costs incurred on this work totalled \$209,034 or an average of \$12.34 per mile excluding miscellaneous markings.

PRINCES HIGHWAY EAST

The completion of the sealing of the Princes Highway East from Melbourne to the New South Wales border was celebrated by a ceremony sponsored by the Orbost Shire Council which took place at Genoa on 17th January, 1967. The main address to mark the occasion was delivered by the Deputy Premier, the Hon. A. G. Rylah. Other speakers were Councillor E. W. Johnstone, the Orbost Shire President who welcomed the guests, Councillor J. H. Gordon, representing the President of the Shire of Imlay in New South Wales, Mr. Bruce Evans, M.L.A., the Hon. R. W. May, M.L.C., Mr. S. G. Mauger, M.L.A. for Monaro, Mr. J. A. L. Shaw, Commissioner for Main Roads, New South Wales, and the Board's Chairman, Mr. I. J. O'Donnell.

When the Board was constituted in 1913, a road actually existed between Melbourne and the New South Wales border. It is on record, however, that settlers in the Genoa district, at Wangarabell and near the Mallocoota Lakes could not carry on business within their own State but traded through the Port of Eden, 45 miles north of Genoa in New South Wales rather than travel twice that distance in poor conditions to Orbost.

Further west the roads in the Shires of Rosedale, Maffra and Avon were considered to be "exceedingly good" because of few engineering difficulties and the abundance of excellent gravel which was easily accessible and widely distributed. These conditions did not extend to Melbourne, however, as the sections of the main Gippsland road in and near Drouin, Warragul and Trafalgar were recorded as being "impassable during the winter months".

An extract from the Board's Annual Report for the year ended 30th June, 1921 reads:

“On the occasion of the visit of H.R.H. The Prince of Wales in 1920 and at the instance of the National Roads Association the main Gippsland road in this State from Melbourne easterly to the border of New South Wales was with the consent of His Royal Highness named the Princes Highway.”

In 1924 the Government passed the Highways and Vehicles Act which provided for the declaration of State highways and for the Board to assume responsibility for the full costs of construction and maintenance of such highways.

The Princes Highway East was declared a State highway on 1st July 1925 and the Board's Annual Report for that year records that the general atmosphere of pessimism and despair that existed throughout the territory (Gippsland), when the Board made a detailed investigation of its road requirements 12 years earlier had almost disappeared and had been succeeded by a feeling of confidence and hope for the future.

The final stages of sealing the full length of the highway have been carried out over the last 10 years between Bellbird Creek, 263 miles east of Melbourne and the New South Wales border at 320 miles. In 1961/62 the construction of the Club Terrace Loop deviation provided a completely new road for a length of 10.25 miles diverting traffic from a 15 mile length of narrow sub-standard road passing through the township of Club Terrace. By 1964, 5½ miles of highway near Mount Drummer remained to be sealed and this has now been completed with special care being taken to preserve the scenic beauty and flora through the Alfred National Park.



Princes Highway East at Hospital Creek after construction of the deviation, 1967.



The road at Hospital Creek, Orbost Shire at the time of the Board's first inspection 1913.

SNOW CLEARANCE IN THE ALPS

The increasing popularity of the Victorian snow resorts has led to demands for quicker and more efficient clearance of snow on the tourists' roads leading to them.

The clearance of snow from roads is not simply a matter of pushing it off the pavement to make way for wheeled vehicles. Efficient clearance results from detailed research into the qualities of snow which are astonishingly variable. The physical properties such as density, internal friction and plasticity vary over a wide range and although all snow is white and cold, no fewer than 200 different types exist which themselves change with varying air temperature and wind.

Australian snow tends to be wet and has the unfortunate characteristic of being up to three times as heavy when freshly fallen as European snow. As the snow lies on the ground its density increases further so that within a month its weight per cubic foot may have increased threefold.

The aim in snow removal is to make the road trafficable and there are four basic methods of doing this:

1. Compacting the snow to make it firm and capable of supporting vehicular traffic.
2. Heating to melt the snow.
3. Pushing the snow off the road surface.
4. Throwing the snow clear of the road.

The first two of these methods are very inefficient and expensive. Over the years the Board has evolved special blades for attachment to graders and bull-dozers to push the snow off the road surface. As the snow season progresses however, the "windrows" formed when pushing the snow off the road can cause serious obstruction to further snow clearance.

To overcome some of the problems of snow clearance including windrow removal, "snow blower" machines which throw the snow clear of the road are now being used by the Board. Snow blowers are of three types:

1. Frontal turbine machines which are effective in deep fresh dry snow.
2. Milling machines which can cut old compacted snow but cannot deal satisfactorily with light fresh snow.
3. Turbo-milling machines which are effective on all types of snow as they combine the actions of the first two types.

The new machines purchased by the Board are turbo milling machines made in Switzerland. Following the success achieved from the use of a Rolba R400 machine, a second R400 and a larger R1500 were purchased during the year. The R1500 has two engines developing a total of 375 horsepower and is capable of clearing a path 8 feet wide and removing 1500 tons of snow each hour.

These additional units should enable the Board to clear snow more efficiently and result in roads being open earlier to traffic after snowfalls.



Rolba R1500 Snow Blower at work.

ROADSIDE DEVELOPMENT



A wayside stop on the Grampians Tourists' Road—Shire of Wimmera.

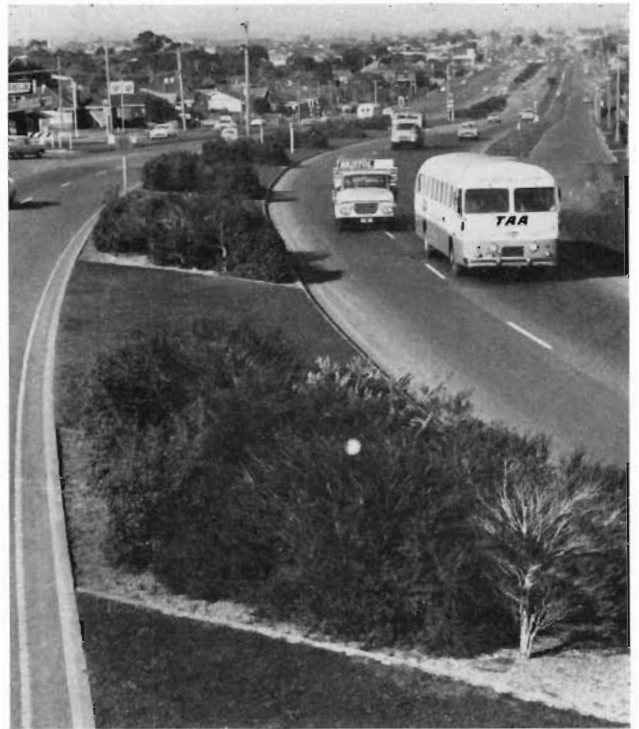

Calder Highway—Shrubs planted in the narrow median reduce headlamp glare and risk of cross median accident.

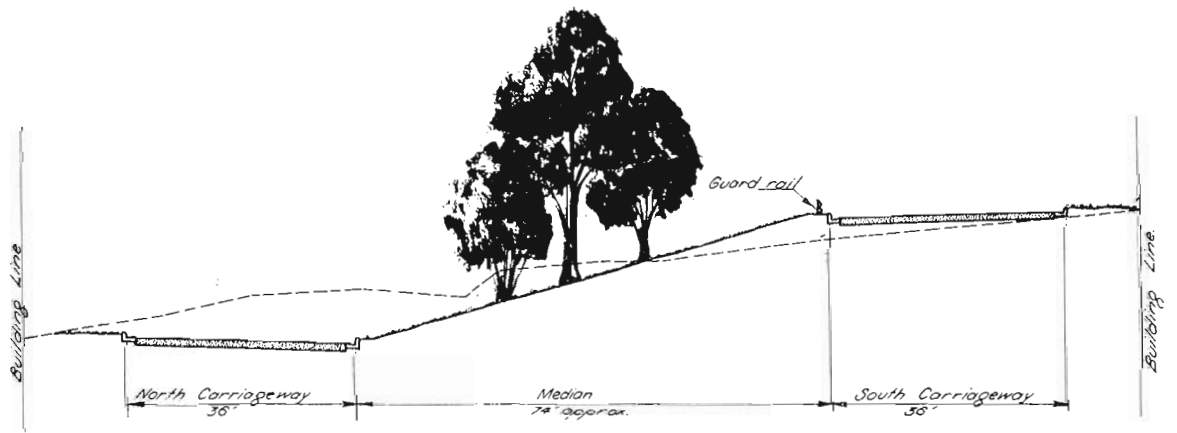

MAROONDAH HIGHWAY - RINGWOOD

Proposed treatment—Trees on a wide median protected by a guard rail.

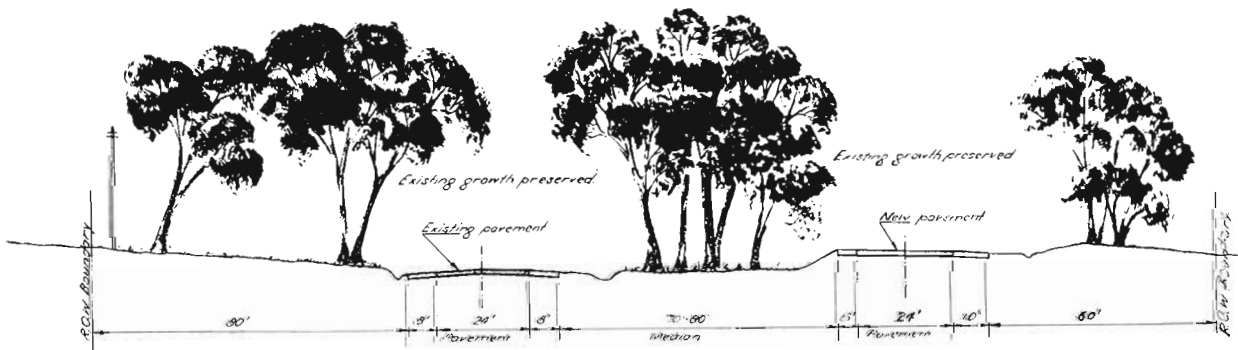

**RURAL MULTIPLE-LANE DIVIDED HIGHWAY
HUME HIGHWAY AT 50.5 M.**

Road alignment selected to preserve existing trees.

ROADSIDE DEVELOPMENT

When the Board was established in 1913, the standard of roads in Victoria was so poor that any road which was traffickable in all weathers was considered adequate. With passing years and increased numbers and weight of traffic, improvements to the pavement and its geometry have been of prime importance.

Roadside development has always been an important consideration and has been actively pursued within the limits of available funds, but it has been possible only in recent times to intensify activities towards the development of what is termed the complete highway to provide a balanced combination of safety, utility, economy and beauty. Modern traffic has necessitated the provision of wide formations, improved alignment and better visibility leading to substantial increases in earthworks and clearance of natural vegetation.

Such factors as the preservation of flora, conservation of landscape features, rehabilitation of cleared areas and erosion control are important aspects of modern road design practices. Roadside features reduce the tension of drivers by helping to keep them alert and interested. Motorists can now travel several hundred miles in a single day. This has produced a demand for frequent wayside stops where motorists can enjoy a meal, view the surroundings, or admire a view from a safe position clear of the road pavement.

The Board is developing roadside stopping places at various locations adjacent to the more heavily trafficked declared roads of the State. Such stopping places include rest areas, wayside stops, scenic view points and parking bays.

Rest areas are developed to provide space for parking vehicles, picnic table bench units, fireplaces, litter bins and, where maintenance can be assured, water and toilet facilities. Rest areas are completely separated from the road formation.

Wayside stops are small rest areas with limited facilities including table bench units, litter bins and perhaps a fireplace.

Scenic view points are established to enable road users to park clear of the road pavement and admire the scenery.

Parking bays are provided to enable the drivers of heavy transport vehicles to stop and relax.



Kiewa Valley Highway—Scenic viewpoint overlooking Mt. Bogong.

BRIDGES

NEW BRIDGES COMMENCED

The construction of 179 new bridges estimated to cost \$5,240,000 commenced during the financial year. Work on 70 of these bridges estimated to cost \$3,726,000 proceeded under the direct supervision of the Board's staff and work on 109 bridges, estimated to cost \$1,514,000 proceeded under municipal supervision.

This activity was slightly more than last year when 175 bridges were commenced at an estimated cost of \$5,060,000.

LARGE BRIDGES COMPLETED IN RURAL AREAS

The following are some of the larger bridges completed under the direct supervision of the Board's staff throughout Victoria during the financial year:

- (a) **Seymour Bridges—Goulburn River—Shire of Seymour;** A series of four bridges crossing the Goulburn River and flood channels on a major deviation of the Hume Highway approaching Seymour.

The main bridge is of prestressed concrete beam and reinforced concrete construction 315 feet long by 28 feet between kerbs. The other three bridges are of prestressed concrete slab and reinforced concrete construction and are 369, 136 and 92 feet long respectively by 28 feet between kerbs. The bridges and new deviation replace a steel girder and timber bridge constructed in 1928, having approaches of poor alignment.

- (b) **Sandy Creek Bridge—Midland Highway—Shire of Benalla;** A three span prestressed concrete beam and reinforced concrete bridge 237 feet long by 28 feet between kerbs over Sandy Creek on the Midland Highway in the Shire of Benalla.

The bridge is constructed on a major deviation of the highway resulting from construction of the Nillahcootie Reservoir by the State Rivers and Water Supply Commission.

- (c) **Barwon River Bridge—Princes Highway West—City of Geelong.** This bridge which is 495 feet long was widened from 33 feet between kerbs plus two footways 4 feet 6 inches wide, to 48 feet between kerbs plus two 5 feet wide footways.
- (d) **Signs Bridge—Acheron Way—Shire of Upper Yarra;** A five span reinforced concrete bridge 155 feet long by 28 feet between kerbs plus one 6 feet wide footway over the Yarra River on the Acheron Way at Warburton.
- (e) **Darlington Bridge—Hamilton Highway—Shire of Mortlake;** A six span prestressed concrete beam and reinforced concrete bridge 243 feet long by 28 feet between kerbs over Mt. Emu Creek on the Hamilton Highway near Darlington in the Shire of Mortlake.



Hume Highway—New Bridge over the Goulburn River on the approach to Seymour.

Some of the larger bridges constructed throughout the year under municipal supervision included:

- (a) **Plenty River Bridge—Eltham-Yarra Glen Road—Shire of Eltham;** A three span prestressed concrete beam and reinforced concrete bridge 180 feet long by 28 feet between kerbs. The new bridge replaces an old iron truss and and basalt masonry abutment bridge built over the Plenty River about 1916, having very poorly aligned approaches.
- (b) **Delta Bridge—Valencia Creek—Briagolong Road—Shire of Maffra;** A five span prestressed concrete beam and reinforced concrete bridge 226 feet long by 22 feet between kerbs constructed over the Freestone Creek on the Valencia Creek-Briagolong Road in the Shire of Maffra.

The new bridge replaces an old timber truss bridge originally constructed about 1875, and burnt out in the bush fires of March 1965.

- (c) **Major's Line Bridge—Hurstwood School Road—Shire of Korong;** A three span prestressed concrete beam and reinforced concrete bridge 141 feet long by 22 feet between kerbs over the Loddon River on the Hurstwood School Road in the Shire of Korong.

The bridge is named after the position or line where Major Mitchell crossed the Loddon River on 8th July, 1836. A granite obelisk at the site commemorates the crossing.

- (d) **Frampton's Bridge—Stawell—Joel South Road—Shire of Stawell;** A three span prestressed concrete beam and reinforced concrete bridge 135 feet long by 22 feet between kerbs over the Wimmera River on the Stawell-Joel South Road.

- (e) **Darley Bridge—Bacchus Marsh—Gisborne Road—Shire of Bacchus Marsh;** A three span prestressed concrete beam, reinforced concrete and stone masonry substructure bridge, 172 feet long by 28 feet between kerbs plus a footway, constructed over the Lerderderg River on Bacchus Marsh-Gisborne Road in the Shire of Bacchus Marsh. The bridge replaced a very old timber bridge approximately 70 years old, constructed on a poor alignment. The opening ceremony was performed by the Honourable M. V. Porter, M.L.A., Minister of Public Works on 10th August, 1967.

- (f) **Devlins Bridge—Yea-Glenburn Road—Shire of Yea;** A five span composite reinforced concrete and steel girder super-structure 182 feet long by 24 feet between kerbs. The new bridge replaced a narrow timber deck bridge on the old reinforced concrete piers and abutments.



Delta Bridge over Valencia Creek, Briagolong Road—Shire of Maffra.

METROPOLITAN BRIDGES AND OVERPASSES

During the year the construction of the Raleigh's Road Bridge over the Maribyrnong River on the boundary of Sunshine and Essendon Cities was completed. The new bridge, constructed in prestressed and reinforced concrete, is 478 feet long by 50 feet between kerbs including two tram tracks plus two 6 feet wide footways. The new bridge replaces the old road traffic bridge on a poor alignment and also the separate tramway bridge.

In addition to the usual assistance afforded to municipal councils in the metropolitan area in the design and construction of bridges the Board:

- (a) continued with the construction of the remaining four of the eleven necessary structures on the Tullamarine Freeway north of the Essendon aerodrome;
- (b) commenced the construction of a bridge over Pascoe Vale Road as part of the construction of the Strathmore By-pass road.
- (c) acting as the construction authority for the Melbourne City Council commenced the construction of the approach bank and bridge spans for the new road over rail overpass at Dynon Road. The section of the bridge over the railway lines is being constructed by the Railways Department.

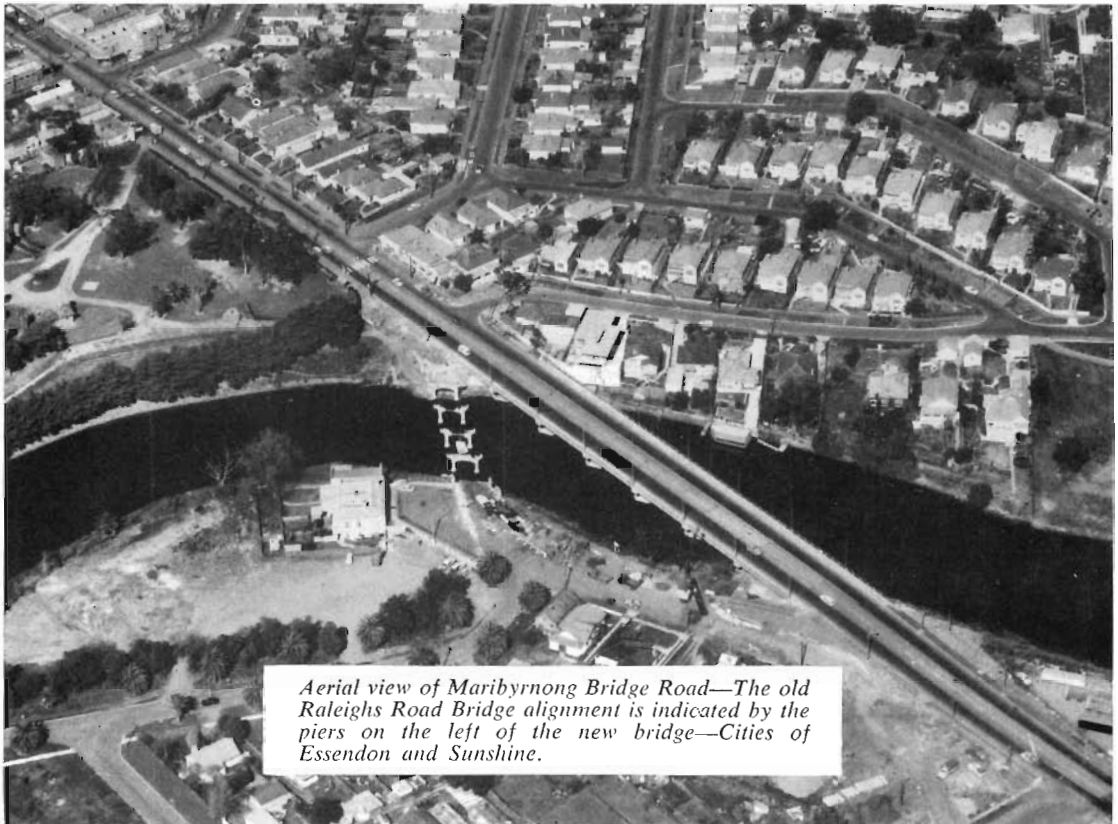

Aerial view of Maribyrnong Bridge Road—The old Raleighs Road Bridge alignment is indicated by the piers on the left of the new bridge—Cities of Essendon and Sunshine.

BRIDGE AND CULVERT MATERIALS

A total length of 208,400 lineal feet of reinforced concrete pipes at a cost of \$388,000 was supplied to bridge works throughout the State for which the Board provided funds in whole or in part. The total length supplied last financial year was 206,400 lineal feet.

The requirements of all sizes of precast reinforced concrete box culverts for Board's and municipal works totalled 27,900 lineal feet at an approximate cost of \$128,000. Production in the Board's precasting yards amounted to 4900 tons of High Strength U slabs valued at \$181,000 and 3600 tons of precast reinforced concrete piles valued at \$113,000.

The tonnage of prestressed concrete bridge components purchased by the Board increased by approximately 12 per cent over last financial year. Components having a contract value of \$281,000 were supplied during the year.

Approximately 2900 tons of reinforcing steel valued at \$408,000 was used in bridges constructed with Board funds during the year. Six hundred tons of rolled steel girders were used.

There was a 56 per cent increase over last year in the length of corrugated steel guardrail used. 90,400 lineal feet of such guard railing costing \$64,800 was used. Corrugated steel pipes and culverts valued at \$122,200 were also used.

NEW DIVISIONAL OFFICE, BALLARAT

The Board was very pleased that the Honourable Sir Henry Bolte could officially open the new Divisional Office and Laboratory at Ballarat. The ceremony was performed on 11th November, 1966.

The Ballarat Division was formed in 1948 from part of the old Stawell District and the new organization moved into temporary accommodation in the Old Court House in Camp Street, Ballarat. The temporary offices finally became too cramped for efficiency and the Board decided that a new office and laboratory building was essential.

The new building consists of a ground floor and upper floor with the laboratory at lower ground level at the rear. The new building is designed to permit the extensive use of demountable partitions for complete flexibility in the use of space over the floor area of 10,000 square feet.

The architects for the building were Messrs. Leith and Bartlett Pty. Ltd. of Melbourne and the builders were the local firm of Messrs. W. G. Feary & Sons, Ballarat.



The Hon. Sir Henry Bolte, K.C.M.G., M.L.A., with the Chairman Mr. I. J. O'Donnell and Divisional Engineer Mr. F. F. O'Brien at the opening of the new Ballarat Office.

FLOOD DAMAGE

Heavy rains in Orbost Shire in the first week of October 1966, when 14 inches was recorded at Cann River, caused major damage to culverts and batters and washed away the approach to the Reedy Creek bridge on the Princes Highway East, causing the highway to be closed for one and a half days. Temporary communication was restored by the erection of an emergency (C.B.G.) bridge, 80 feet long, but permanent repairs were not completed until January 1967. The total cost of works was \$30,000.

Severe flooding also occurred in the Benalla area during December 1966, and special allocations were made to municipal councils for restoration work to bridges and culverts washed away and damaged pavements. Allocations totalling \$90,250 were made, subject to Council contributions of \$18,050.



Princes Highway East—Washed away approach at the Reedy Creek Bridge—Orbost Shire.

WORKS CARRIED OUT ON BEHALF OF OR IN CONJUNCTION WITH OTHER GOVERNMENT AUTHORITIES

TOURIST DEVELOPMENT AUTHORITY

The Board is required to make an annual payment into the Tourist Fund amounting to 2 per cent of the amount credited to the Country Roads Board Fund from receipts under the Motor Car Act. An amount of \$493,805 was paid by the Board during the year. The Tourist Fund is administered by the Tourist Development Authority.

Once again the Government provided \$200,000 for expenditure by the Board in conjunction with the Tourist Development Authority on roads of tourist interest other than proclaimed tourists' roads.

The funds were expended on roads giving access to places which offer attractions to tourists including

- The access road to Mt. Baw Baw via Mt. Gwinear.
- The Mount Difficult Lookout Access Road in the Grampians Tourist Area.
- The extension of Mount Buller road through the Alpine village towards the summit of Mt. Buller.
- The Cape Paterson road towards Inverloch.
- The Lake Mountain Access Road in Healesville.

In addition, Shire allocations were made for the continuation of work on the Dargo High Plains Road and Jerusalem Creek Road and for the completion of work on the Upper Kiewa Valley Road extension from Langfords Gap to the Omeo Highway.

NATIONAL PARKS AUTHORITY

Work continued on roads in or adjacent to National Parks using funds made available by the Government for this purpose. The whole amount of \$100,000 available was allocated with the approval of the National Parks Authority for work on roads in or near:

- The Port Campbell National Park
- The Frazer National Park
- The Glenaladale National Park
- The Mt. Buffalo National Park
- The Kinglake National Park

At 30th June 1967, \$289,636 had been expended from the total provision of \$400,000 made available by the Government since 1st July, 1963.



Work is progress on the approach to the Frazer National Park—Lake Eildon in the background.

RURAL FINANCE AND SETTLEMENT COMMISSION

Works carried out in conjunction with the Rural Finance and Settlement Commission were continued in the Heytesbury Settlement area. As in the past the costs were shared on the basis of Country Road Board three eighths, Rural Finance and Settlement Commission one-half and the municipal council concerned one-eighth.

During the year, approximately 5.5 miles of new road were constructed with a formation width of 30 feet. In addition, one reinforced concrete bridge was constructed. Total expenditure during the year was \$270,000.

ELIMINATION OF RAILWAY LEVEL CROSSINGS

In continuation of its programme for the progressive elimination of railway level crossings in conjunction with the Victorian Railways Department, the Board was concerned with the construction of the following projects during the year:

Tuaggra Street Underpass—Pyrenees Highway—City of Maryborough

A road under rail underpass with provision for dual road carriageways and a pedestrian underpass was completed.

French Street Overpass—Glenelg Highway—City of Hamilton

A three span overpass bridge having dual carriageways each 24 feet wide with approaches totalling 0.17 mile was constructed at a cost of \$430,000.

Gheringhap Overpass—Midland Highway—Shire of Bannockburn

A three-span composite steel girder and reinforced concrete overpass structure 161 feet long by 28 feet between kerbs on a 50° skew was constructed by the Board crossing the Geelong-Ballarat railway line.

Kaniva Overpass—Western Highway—Shire of Kaniva

A three span composite steel girder and reinforced concrete overpass structure 210 feet long by 28 feet wide between kerbs across the Melbourne-Adelaide line on a 67° skew.

Buangor—Hillside Road—Shire of Ararat

A new deviation was constructed under municipal supervision to eliminate a railway level crossing.

Level Crossing projects were financed on the usual basis, with the Board paying 45%, the Level Crossings Fund 30%, and the Victorian Railways Department 25%. Expenditure during the year amounted to \$1,615,000 of which the Board contributed \$616,000.



The Minister of Public Works, the Hon. M. V. Porter, M.L.A., becomes the first official traveller to use the Tuaggra Street underpass in Maryborough City. The opening ceremony was attended by the Chairman and Member of the Board, the Mayor of Maryborough and other invited guests.

STATE RIVERS AND WATER SUPPLY COMMISSION

Work continued on the deviation of the Midland Highway in connection with the construction of the Nillahcootie Dam. Earthworks, culverts and drainage works were carried out by the Commission and pavement works by the Board. A total of 4.50 miles of road works and a three span reinforced concrete bridge 237 feet long and 28 feet wide between kerbs were completed at a cost of \$455,800.

ROAD MATERIALS AND RESEARCH

The Board continued its activities in locating sources of road making materials for its own and municipal roadworks. The methods used to locate underground deposits not apparent from surface inspection have mainly been concerned with the measurement of the electrical resistance of soil and the analysis of shock waves. The presence of deposits which may be promising as disclosed by these preliminary surveys are then confirmed by boring. Progress is being made in the application of electronic computer technique to these test results and a number of programmes have been developed.

The Board's Horsham Division includes areas severely lacking in good road making materials and over the years Divisional Engineers, in collaboration with the Materials Research and Asphalt Divisions, have developed techniques for the satisfactory use of locally available decomposed sandstone which is normally regarded as a sub-standard road making material.

The methods adopted in the location, winning and use of sub-standard road making materials in Horsham Division has raised interest in other States of Australia.

During the year, engineers from the Queensland Main Roads Department visited the Division to examine the sandstone and the methods of using it. The use of similar materials in South Australia was examined by Board's engineers.

CONTROL OF HEAVY TRAFFIC

During the year the Board's Traffic Officers and Police Officers seconded to the Board were responsible for the successful prosecution of 6337 offences under the Motor Car Act. The fines and costs imposed amounted to \$266,794.

The number of prosecutions was approximately 1000 less than in financial year 1965/66. Some reasons are considered to be:

- (a) the implementation by the issue of permits of the increase in the permitted axle group loadings adopted by the National Association of Australian State Road Authorities;
- (b) the simplicity of the relationship between axle spacings and the new permitted loadings, enabling operators to readily compile permitted axle loads.

The following table illustrates the increase in the permitted axle group loadings:

Distance Between Axles	Maximum Axle Group Loadings				Increase	
	Old		New		Tons	Cwt.
	Tons	Cwt.	Tons	Cwt.		
Exceeding 40 inches and not exceeding 8 feet	13	0	13	0	—	—
Exceeding 8 feet and not exceeding 9 feet	15	0	15	0	—	—
Exceeding 9 feet and not exceeding 10 feet	15	8	15	10	—	2
Exceeding 10 feet and not exceeding 11 feet	15	17	16	—	—	3
and thereafter a 10 cwt. increase per additional foot between axles, e.g.						
Exceeding 18 feet and not exceeding 19 feet	19	4	20	0	—	16
Exceeding 26 feet and not exceeding 27 feet	22	7	24	0	1	13
Exceeding 34 feet and not exceeding 35 feet	25	7	28	0	2	13
Exceeding 42 feet and not exceeding 43 feet	28	4	32	0	3	16

The load limit on the Ocean Road between Apollo Bay and Peterborough was lifted during the year leaving only the Beech Forest-Lavers Hill Road between Ferguson and Lavers Hill, a distance of nine miles, with a 5-ton axle limit imposed.

The number of permits issued for loads in excess of weights and dimensions prescribed under the Motor Car Act totalled 20,830. The heaviest single load carried during the year under permit was 192 tons. There were 54 permits issued for loads over 90 tons and 224 permits for loads between 70 tons and 90 tons.

Weighbridges were installed at Bairnsdale and Yarragon during the year and additional overhead lighting was provided at most of the other weighbridge sites at Wallan, Kilmore, Seymour, Ballan, Melton and Carlsruhe.

LEGISLATION AFFECTING THE BOARD

The following legislation enacted during the financial year affects the Board:

Country Roads (Level Crossings) (Amendment) Act 1966 (No. 9459)

Prior to the passing of this Act the Level Crossings Fund could be applied towards:

- (a) the elimination of railway level crossings or the provision of alternative routes to enable road traffic to avoid such crossings;
- (b) the provision of lights, signs and lighting at and of improved approaches to railway level crossings;
- (c) generally reducing danger at railway level crossings.

The above provisions did not provide for the cost of boom barriers or other works calculated to improve the flow of traffic across level crossings to be charged to the Level Crossings Funds except where they could be considered to reduce danger.

The amending Act enables the cost of boom barriers and other works calculated to improve the flow of traffic across railway level crossings to be charged to the Level Crossings Fund.

Motor Car (Trailers) Act 1966 (No. 7506)

This Act provides inter alia for:

- (a) registration fees to be levied on private trailers as defined in the Act and for the proceeds to be paid into the Country Roads Board Fund;

- (b) one per cent of the moneys paid into the Country Roads Board Fund from receipts under the Motor Car Act to be paid into the Traffic Commission Fund;
- (c) the Traffic Commission Fund to be used
 - (i) for any works or projects calculated to improve road safety or traffic control;
 - (ii) for or towards the establishment or improvement of school crossings or pedestrian crossings;
 - (iii) for or towards the construction, purchase and installation on any road of traffic lights, and
 - (iv) for or towards the costs of administration of and with respect to the carrying out of the functions of the Traffic Commission;
- (d) the repeal of Sections 39(3) and 39(4) of the Country Roads Act which permitted payments to be made out of Country Roads Board Fund for the installation of traffic control lights.

Instruments (Corporate Bodies Contracts) Act 1967 (No. 7547)

This Act provides that any person acting under the authority of a body corporate may make, vary or discharge any contract in the name of or on behalf of the body corporate in the same manner as if that contract were made, varied or discharged by a natural person. This additional provision, however, does not prevent a body corporate from making, varying or discharging a contract under its common seal.

Limitations of Action (Notice of Action) Act 1966 (No. 7457)

This Act repealed a previous provision which required any prospective plaintiff to give any public authority such as the Board notice of an intended action within six months after the event causing the action.

This amendment could increase the number of claims received by the Board arising from accidents on roads under its control.

The Pipe Lines Act 1967 (No. 7541)

This Act which has not yet come into operation, inter alia, permits pipe lines to be constructed in the Board's road reserves subject to prescribed controls.

FILMS AND DISPLAYS

During the year the Board's film unit produced two movie films. One film is entitled "Signs for Safety" and covers the use and interpretation of traffic signs and pavement markings. The second film concerns Special Road Project No. 14 and portrays the planning and construction of the first stage of the proposed new road between Marlo and Mallacoota in the Shire of Orbost which has already been completed from Marlo as far east as Cape Conran.

A display of photographs of Board's works taken by the Board's Senior Photographer, Mr. T. Scott, received first prize in a section of the photographic contest held as part of the 1967 Moomba Pacific Fair. The trophy was received on behalf of the Board by Mr. F. West, Member, at a special prize giving function.

Among the more important exhibitions at which the Board displayed an exhibit were the Royal Agricultural Show, the Motor Show and the Science in the Development of Australia Exhibition sponsored by the Science Teachers' Association of Victoria. The Board's exhibits included detailed models of road and bridge works, colour and monochrome photographs and transparencies and film shows. The overall theme at the Agricultural Show and Motor Show was road safety, while the Science in the Development of Australia Exhibition publicized careers available in the Board with the emphasis on pure and applied science.

The Board was gratified by the interest shown by the public generally in the Board's displays and the appreciation shown in response to the pamphlets and brochures made available.



The Country Roads Board stand at the International Motor Show.

CONFERENCES

MUNICIPAL ENGINEERS

The twenty-third Conference of Municipal Engineers arranged by the Board was held on 15th and 16th February, 1967. Attendance was approximately 240, including engineers from most of the municipalities in the State, visiting municipal engineers from South Australia and Tasmania, representatives from various Commonwealth and State Government Departments and Instrumentalities, Members of the Board and senior engineers of the Country Roads Board.

The Conference was officially opened by the Hon. M. V. Porter, M.L.A., Minister of Public Works.

There were twenty-three topics for discussion covering a broad range of subjects of interest to the municipal engineer. Papers presented included those on free overfall drop structures for erosion control, drainage of urban street intersections, low volume rural intersections, pavement marking procedures and standards, developments in priming and primer seals, compaction of road subgrades and pavements, search for gravel using mapping, photogrammetric and geophysical techniques, lime stabilization of clay subgrades, maintenance and repair of traffic signs, drainage in the Dandenong Creek catchment—powers and problems, drainage problems on rural roads in Western Victoria, personnel and industrial relations, safety for roadworkers, and snow removal—outline of procedures. A talk was given on an overseas visit and discussion topics were: use of slurry seals for retreatment work, clearing roadsides after construction work, Phillip Island bridge, developments in road construction plant, road needs survey and Commonwealth Bureau of Roads, training methods for outdoor employees and preparation of engineering manuals.

It is customary for the Conference to close with a field inspection and this year an inspection of works in progress at Melbourne Airport (Tullamarine) was arranged by the Commonwealth Department of Works. Inspection of the quarry, crushing and screening plant, bituminous surfacing and concrete paving was arranged and a general description of the airport construction was given by Commonwealth officers.

The Board expresses appreciation to the Engineers who submitted papers or led discussions at the Conference, and to the Commonwealth Department of Works for its assistance in arranging the field inspection.

MUNICIPAL ASSOCIATIONS

The Board was represented at the opening session of the annual conference of the Municipal Association of Victoria and at various annual conferences of the District Municipal Associations.

The following conferences were attended during the year:

1. Municipal Association of Victoria Conference held at Melbourne on 12th and 13th October, 1966—attended by the Chairman and Board Members.
2. Goulburn North-East Municipalities Association conference held at Shepparton on 30th March, 1967—attended by Mr. I. J. O'Donnell, Chairman.
3. Gippsland Municipalities Association conference held at Frankston on 31st March, 1967—attended by Mr. I. J. O'Donnell, Chairman.
4. Western District Municipalities Association conference held at Portland on 31st March, 1967—attended by Mr. R. E. V. Donaldson, Deputy Chairman.
5. Northern District Municipal Association conference held at Bendigo on 27th April, 1967—attended by Mr. F. West, Member.
6. North Western Municipalities Association conference held at Donald on 26th May, 1967—attended by Mr. A. J. Pryor, Divisional Engineer, Horsham.

The Board records its appreciation to these Municipal Associations for the opportunity of attending the Conferences. A knowledge of local conditions and of the problems of development in different parts of the State derived from these Conferences is of great value to the Board Members in considering the development of the State road system.

MUNICIPAL INSPECTIONS AND DEPUTATIONS

Members of the Board and the respective Divisional Engineers made official visits to 32 municipalities during the year.

Roads, bridges and sites of local interest were inspected in the Shires of Avon, Bairnsdale, Ballarat, Bass, Bright, Cranbourne, Creswick, Diamond Valley, Dundas, Dunmunkle, Glenelg, Gordon, Kara Kara, Korong, Myrtleford, McIvor, Ripon, Rochester, Stawell, Swan Hill, Talbot and Clunes, Wannon and Yea; the Towns of Stawell and St. Arnaud; the Borough of Sebastopol; and the Cities of Ballarat, Doncaster and Templestowe, Hamilton, Heidelberg, Moorabbin and Swan Hill.

The Board continues to find these visits of great value. They provide opportunities to discuss matters of mutual interest with councillors and senior local government officers, and enable the Board Members to maintain up to date first hand knowledge of road developments throughout the State.

The Members of the Board would again like to express their appreciation to the municipal councils visited during the year for their welcome and hospitality and for the excellent preparatory work carried out by municipal officers.

DEPUTATIONS

The Board is always prepared to meet deputations from municipal councils or representatives of local interests. Many matters, particularly those involving the provision of additional funds, are not capable of immediate solution, but discussions with deputations do provide a forum for an exchange of views and information.

Twenty-three deputations were received from municipal councils by the Board during the year and the Board was represented at six deputations received by the Minister of Public Works.

NATIONAL ASSOCIATION OF AUSTRALIAN STATE ROAD AUTHORITIES

The Association, which comprises the State Road Authorities and the Commonwealth Department of Works, held its Thirty-third meeting in Sydney from 7th to 11th November, 1966. Representatives of the Department of Shipping and Transport, and the Common-

wealth Bureau of Roads were also present by invitation when matters relating to the Permanent International Association of Road Congresses, road needs survey, road and bridge design and motor vehicles standards were under discussion. The Board was represented at this meeting by the Chairman, Mr. I. J. O'Donnell.

Mr. J. A. L. Shaw, Commissioner for Main Roads, New South Wales, was appointed Chairman for the 1966/67 year.

There were over ninety items on the agenda, including N.A.A.S.R.A. representation on the Standards Association of Australia Committees and matters referred to these Committees, preparation of technical manuals—bituminous surfacing, road and bridge design, materials quality control, road signs, use of computers, pavement markings, plant and equipment, exchange of research information, national route numbering, maximum weights for vehicles, annual reports, publicity and roads legislation.

The second meeting for the year, the Thirty-fourth meeting of the Association, was held at the Board's Head Office, Kew, on 18th May, 1967. The three Members of the Country Roads Board were present at this meeting.

Among the items discussed were S.A.A. Committee matters, N.A.A.S.R.A. technical publications, national route numbering, location of installations by public authorities on road reserves, job costing, pedestrian overpasses and subways, road needs survey, road conferences, standards for large freight containers, maximum dimensions of vehicles, control of weights of vehicles and speed limits.

AUSTRALIAN ROAD RESEARCH BOARD

The Third Biennial Conference of the Australian Road Research Board was held in Sydney from 4th to 9th September, 1966. The Board was represented at the Conference by Mr. I. J. O'Donnell who continues to hold the office of Deputy Chairman of the Australian Road Research Board.

Eighty papers were presented, including six by Country Roads Board Engineers, covering a wide range of research matters including traffic engineering, motor vehicle performance, roadmaking materials, road and bridge construction and design, use of computers, town and transportation planning, plant and equipment, accident analysis. Over 500 delegates from all States and overseas attended the Conference.

The sixth and seventh meetings of the Board of Directors were held on 6th September and 9th November 1966 respectively.

The third Annual General Meeting of the Road Research Board was held at Kew on 16th May, 1967, followed by the Eighth Meeting of the Board of Directors on 16th and 17th May, 1967. Mr. R. C. Sharp, Director of Public Works, Tasmania, was appointed Chairman for the ensuing year.

The research work undertaken by the Specialist Committees was reviewed—Human Factors, Traffic Flow and Operations, Road Transport Economics, Pavement Design, Compaction, Brittle Fracture, Bituminous Materials and Stabilization. A research programme for the next twelve months, staffing, administrative procedures, publications and attendance at overseas conferences were also discussed.

The Road Research Board has purchased approximately sixteen acres of land on Burwood Highway, City of Nunawading for the erection of permanent accommodation. Planning is proceeding for the new building to be erected in 1968, and this will free the accommodation in the C.R.B. Materials Laboratory building at present occupied by the Road Research Board.

PERSONNEL

The number of personnel employed by the Board at 30th June, 1966 and 30th June, 1967 was as follows:

	<i>1966</i>	<i>1967</i>
Salaried Staff	1179	1245
General Staff	802	837
Award Employees	2169	2259
	<hr/>	<hr/>
Total	4150	4341
	<hr/> <hr/>	<hr/> <hr/>

RECRUITMENT

The demand for civil engineering graduates once again far exceeded the number available and the Board's cadetship scheme was still the main source of recruitment of prospective engineering graduates. In an endeavour to recruit qualified scientific staff and to overcome present shortages of qualified staff in the Materials Research Division, two cadetships were offered for the first time in Science.

More than the usual number of newly qualified diplomate engineers were recruited during the year in an endeavour to offset the reduced number of diplomates which will be available at the end of 1967. Fewer engineering diplomates will be available for recruitment because of the amendment to the diploma course entrance requirements from Intermediate certificate to Leaving Certificate standard. The availability of diplomates should resume usual proportions at the end of 1968.

A recruitment campaign in the United Kingdom to obtain experienced engineers was not very successful. Ten qualified engineers were offered positions with the Board but only two eventually accepted.

During the year representatives of the Board's Personnel Section visited 45 schools and 37 career nights to discuss careers with senior students. These visits are in response to an increasing number of requests received by the Board for participation in this very popular type of activity. The time devoted to this activity is considered to be well worthwhile and reflects the general high quality of applicants for employment with the Board.

Apart from metal tradesmen and plant operators, there were no difficulties in the recruiting field, depot and workshop employees.

STAFF RETIREMENTS

The following officers with substantial service, retired during 1966/67:

BULLOCK, S. H.	Clerk	Mechanical Sub Branch	20 years
FOSTER, M. W.	Engineering Surveyor	Plans and Survey Section	45 years
GALBRAITH, J. R.	Divisional Engineer	Metropolitan Division	15 years
HELSHAM, F. K.	Divisional Accountant	Warrnambool Division	18 years
KITCHEN, N. T.	Stock Control Officer	Accountant's Branch	(Retired because of ill health)
SHANKLAND, A. C.	Engineering Assistant	Dandenong Division	40 years
WESTON, W. S. G.	Clerk	Benalla Division	33 years

With regret the death of the following officers is recorded:

JONES, R. C.	Engineer	Dandenong Division	27 years
PEDEN, J. L.	Estates Officer	Secretary's Branch	19 years

INDUSTRIAL RELATIONS

There were many industrial matters which affected the Board. Three National Wage Cases were determined during the year by the Commonwealth Conciliation and Arbitration Commission, viz in July 1966, the basic wage for adult males was increased by \$2 per week with proportionate increases for adult females and juniors; in December 1966, interim margins were awarded ranging from 1% to 2½%; in June 1967 the concept of a total wage was introduced in place of the basic wage and margins concept, and at the same time an increase of \$1 per week was awarded to adult males and females. As a result of the National Wages Cases the Board will incur approximately \$1,000,000 per annum in additional direct wage and salary payments.

The important inquiry conducted by Commissioner Winter into the Metal Trades Award wage and classification structure was still proceeding at 30th June, 1967. Arrangements were in hand for the Board's Workshops at Syndal Depot to be inspected by the Conciliation and Arbitration Commission during the course of the Inquiry.

During the latter half of 1966 the Association of Professional Engineers' claim for higher salaries for senior engineers employed by the Melbourne and Metropolitan Board of Works and the Country Roads Board was heard by Commissioner Portus. This was the first occasion in Victoria that the salaries of the senior level of engineering officers in State authorities were subject to detailed arbitration. All professional engineers on the Board's staff are now covered by a Federal Award of the Conciliation and Arbitration Commission. The Board was also concerned in much detailed work leading up to an amended method of assessment of plant operators' margins contained in the Australian Workers Union Construction and Maintenance Award 1966. This new method, together with increasing camping allowances followed an extensive hearing which included detailed inspections by the Commissioner of work situations in Victoria and Tasmania.

SECONDMENT FOR SERVICE OUTSIDE AUSTRALIA

During the year, the Board agreed to the secondment of five officers for governmental service outside Australia. They were:

Mr. R. Gooch, Engineer Class 3 and

Mr. P. Byrne, Workshop Foreman to a Colombo Plan project in the Lesser Sundas, Indonesia.

Mr. R. Gowan, Engineer Class 1 and

Mr. D. Judd, Clerk to the Public Service of Papua and New Guinea.

Mr. M. J. Corry, Surveyor to the Amery Ice Shelf Expedition in Antarctica.

NATIONAL SERVICE TRAINING

At 30th June, 1967 there were 15 Board's officers and employees undergoing National Service training. Two officers, namely Mr. D. Bryant, Correspondence Section, Head Office and Mr. K. Morrison, Traffic Section, Head Office, saw service in Vietnam.

TRAINING

The Board sent certain senior officers on external training courses during the year. These courses included the Victorian Public Service Board's fortnightly residential Management Conference, the Advance Course of the Australian Administrative Staff College and the Administrative Staff Course of two weeks at the University of New South Wales.

Training courses conducted within the Board during the year included:

- (a) Induction of Salaried Staff (seven one-day courses)
- (b) No. 4 Administrative Officers Course (main theme Work Simplification)
- (c) Transition Course for Graduating Cadets
- (d) Induction of new Cadets
- (e) PERT and CMP Course (a two-day course for thirty engineers)
- (f) Communication Course
 - (i) A Pilot Course for senior officers;
 - (ii) An abridged course for senior administrative officers

- (g) Country Roads Act Course for senior administrative officers
- (h) Specialist training courses in the Mechanical Sub-branch and the Traffic and Location Section.

The Apprentice Centre at Syndal provided full time training for 12 first year and 10 second year motor mechanic apprentices. Throughout the Board there are 64 apprentice motor mechanics, painters and fitters and turners. Twenty-six of these are located in country Divisions.

Following detailed consideration by the Training Steering Committee and a special committee appointed by the Chief Engineer to consider the training of young qualified engineers, a pilot scheme was introduced to provide young engineers with a variety of experience in their early years with the Board. The period of training is expected to extend over 30 months.

The Board encourages its unqualified officers to undertake courses of study which will be of benefit to both the officer and the Board. The Principal Training Officer and Training Officer provide expert assistance to the staff with advice on the appropriateness of particular courses of study and by providing general counselling during the period of study. 180 officers on the staff were undertaking courses of study during the 1967 academic year.

CADETSHIPS

Eleven cadetships in Civil Engineering, one in Commerce, two in Science and one in Mechanical Engineering were awarded by the Board for university training in 1967. Four cadetships in Land Surveying at the Royal Melbourne Institute of Technology were also awarded.

As usual, the new cadets attended a special induction programme preceding their academic studies. The very high percentage (93%) of passes obtained by the Board's cadets during the 1966 academic year reflects on the standard of cadets selected, and also the general advice provided by the Principal Training Officer and Training Officer. Forty-four Cadets completed their courses at the end of 1966 and commenced full time duty with the Board. The continuation of the cadetship scheme will assist in the provision of qualified, professional officers to carry out the Board's future programme of work.

The following table shows the number of Board's cadets at the Universities and the Royal Melbourne Institute of Technology in the 1967 academic year:

Cadets under Training	Civil Engineering	Mechanical Engineering	Commerce and Economics	Land Surveying	Science	Total
1st Year	4	—	—	—	1	5
2nd Year	8	—	2	4	2	16
3rd Year	10	—	1	1	—	12
4th Year	9	1	—	1	—	11
Total	31	1	3	6	3	44

APPENDIX 1

STATE HIGHWAY AND BY-PASS ROADS

SIGNIFICANT WORKS COMPLETED DURING FINANCIAL YEAR 1966/67

PRINCES HIGHWAY WEST

CITY OF FOOTSCRAY	Reconstruction with dual carriageways to provide a six lane highway between Robbs Road and Somerville Road, a distance of 0·6 mile.
CORIO SHIRE	Construction of a rest area and Transport Regulation Board run-off bay near mileage 31·5 on the southern carriageway.
GEE LONG CITY	Widening the bridge over the Barwon River to provide four traffic lanes.
COLAC SHIRE	Widening 1·7 miles of pavement near Warncoort to provide a sealed width of 24 feet. Improvements to the intersection with the Colac-Ballarat Road near Camerons Hill.
COLAC CITY	Widening 0·9 mile of pavement between Grant Street and the Colac High School. Reconstruction of 1·34 miles with curve improvement to a sealed width of 24 feet at Gnotuk.
WARRNAMBOOL CITY	Construction of dual carriageways each 35 feet wide over a distance of 1·1 miles.

PRINCES BY-PASS ROAD

WERRIBEE SHIRE	Intersection treatment at Railway Avenue, Laverton. Retreatment of 5·7 miles of the southern carriageway with a slurry seal.
----------------	---

MALTBY BY-PASS ROAD

WERRIBEE SHIRE	Retreatment of 3·0 miles on both carriageways with a slurry seal.
----------------	---

PRINCES HIGHWAY EAST

BERWICK SHIRE	Construction of 1·9 miles of four lane dual carriageways between Doveton and Hallam as part of Special Project No. 6.
BULN BULN SHIRE	Part realignment, regrading and widening of 2·88 miles east of Drouin to provide a sealed width of 24 ft.
MORWELL SHIRE	Construction of dual carriageways over a distance of 1·6 miles between Morwell and Morwell East including intersection treatment at McDonald Street and Jeeralang West junction.
TRARALGON CITY	Reconstruction of 0·7 mile of pavement between Traralgon Creek and the Maffra railway level crossing to provide a sealed width of 34 feet.
BAIRNSDALE SHIRE	Widening and resheeting 3·5 miles including the widening of the bridge over Tom's Creek to provide a sealed width of 24 feet.
TAMBO SHIRE	Restoration of a slip including batter stabilization over a distance of 0·8 mile at Jemmy's Point, Lakes Entrance.
ORBOST SHIRE	Widening and strengthening 2·38 miles and construction of 3·04 miles at Hospital Creek east of Nowa Nowa to provide a sealed width of 24 feet. The work carried out as Special Project No. 10 included the construction of a three-span reinforced concrete bridge 106 feet long and 28 feet wide between kerbs over Hospital Creek.

Reconstruction of 1·43 miles through the Alfred National Park to complete the sealing of the highway to the New South Wales border.

Construction of a three span reinforced concrete bridge 28 feet wide and 131 feet long over Maramingo Creek.

HUME HIGHWAY

BULLA SHIRE	Construction of 4·4 miles of dual carriageways from Craigieburn to Kalkallo as part of Special Project No. 2.
BROADFORD SHIRE	Widening and resheeting 1·45 miles north from Broadford overpass to a sealed width of 24 feet.
SEYMOUR SHIRE	Construction of 1·4 miles of dual carriageways south of Tallarook and 1·3 miles north of Tallarook as part of Special Project No. 8. Construction of four bridges over the Goulburn River and adjacent flood plain at Seymour. Reconstruction of 1·1 miles in Seymour township to provide dual carriageways. Construction of a three cell reinforced concrete culvert 100 feet wide between kerbs in Seymour township.
VIOLET TOWN SHIRE	Intersection treatment at the junction with the Murchison-Violet Town Road to provide four traffic lanes over a distance of 0·4 mile.
WANGARATTA SHIRE	Strengthening the existing bridge over the Ovens River at Wangaratta including the placement of a new reinforced concrete deck. Construction of a new bridge over the Ovens River floodway at Wangaratta. Resheeting and resealing 6·4 miles north of Bowser to a sealed width of 24 feet.
WODONGA SHIRE	Reconstruction of 0·4 mile with a sealed pavement 40 feet wide between House Creek and the Murray Valley Highway junction.



Hume Highway—Four lane dual carriageways in Seymour township.



Hume Highway—Intersection treatment at the junction with the Murchison Violet Town Road—Violet Town Shire.

WESTERN HIGHWAY

SUNSHINE CITY

Reconstruction of 1·14 miles of dual carriageways from east of Kororoit Creek to west of Deer Park including a duplicate bridge at Kororoit Creek.

Construction of a pedestrian overpass at Braybrook State School.

MELTON SHIRE

Construction of 7·12 miles of dual carriageways from Deer Park to Rockbank as part of Special Project No. 5.

BACCHUS MARSH SHIRE

Construction of dual carriageways from Djerriwarrh Creek to Coimadai Creek including the provision of duplicate bridges as part of Special Project No. 5.

BALLAN SHIRE

Construction of dual carriageways on a new alignment 1·83 miles in length east of Pykes Creek Reservoir as part of Special Project No. 7.

ARARAT SHIRE

Reconstruction, regrading and widening of 0·95 mile west of Buangor to a sealed width of 24 feet.

Regrading and widening 1·70 miles west of Mt. Langi Ghiran Overpass to a sealed width of 24 feet.

Construction of a new reinforced concrete bridge 91 feet long and 28 feet wide between kerbs over the Hopkins River at Dobie with realigned approaches 0·87 mile in length to a sealed width of 24 feet.

WIMMERA SHIRE

Widening three bridges and a 8 feet 6 inches reinforced concrete box culvert near Drung Drung and widening, resheeting and regrading 3 miles between Wal Wal Road and Drung school to a sealed width of 24 feet.

Widening and resheeting sections totalling 2·5 miles between Dahlen and Pimpinio to a sealed width of 24 feet.

KANIVA SHIRE

Construction of a road over rail overpass at Kaniva including 0·6 mile of roadworks with a sealed width of 24 feet.

Resheeting, realigning and regrading 2·76 miles near the South Australian border to a sealed width of 24 feet.



Western Highway at the South Australian Border.



Burwood Highway—Dual carriageways east of Warrigal Road—City of Box Hill.



Calder Highway, Marong Shire—Widening to 24 feet sealed width on strengthened shoulders.

CALDER HIGHWAY

KEILOR CITY	Resheeting and surfacing 3·1 miles.
GISBORNE SHIRE	Construction of an additional climbing lane 0·6 mile in length at Gisborne North.
KYNETON SHIRE	Widening a narrow section south of Kyneton to provide a sealed width of 24 feet. Construction of a reinforced concrete bridge 122 feet long and 28 feet wide between kerbs with a footway six feet wide, over the Coliban River at Malmsbury.
METCALFE SHIRE	Widening and construction of climbing lanes over a distance of 1·96 miles south and north of Taradale.
MARONG SHIRE	Strengthening shoulders over a length of 5·2 miles between Ravenswood and Ravenswood South to a sealed width of 24 feet.
WYCHEPROOF SHIRE	Reconstruction and widening of 3·93 miles north of Sea Lake to a sealed width of 24 feet.

BURWOOD HIGHWAY

BOX HILL CITY	Reconstruction and widening of approximately 0·2 mile between Warrigal Road and Edwards Street.
---------------	---

NEPEAN HIGHWAY

MORDIALLOC CITY	Construction of six lane dual carriageways from White Street to McDonald Street, Mordialloc, a distance of 0·4 mile, in conjunction with the construction of a new railway bridge.
FRANKSTON CITY	Reconstruction of 1·0 mile of the eastern carriageway to complete the dual carriageways between Mile Bridge and Wells Street, Frankston. Reconstruction of 1·4 miles at White Cliffs to provide a 24 feet wide sealed pavement.

BASS HIGHWAY

CRANBOURNE SHIRE	Widening and resheeting 1·0 mile near the shire boundary to provide a sealed width of 24 feet.
------------------	--

BELLARINE HIGHWAY

GEELONG CITY	Reconstruction and channelization of the intersection with Myers Street and Garden Street.
--------------	--

BONANG HIGHWAY

ORBOST SHIRE	Reconstruction of 1·84 miles north of Orbost on an improved alignment to a sealed width of 20 feet. Replacement of failing narrow timber bridges with corrugated iron pipe culverts at Youngs Creek and Wild Cow Creek.
--------------	--

BORUNG HIGHWAY

WIMMERA SHIRE	Surfacing shoulders and resheeting sections totalling 4 miles, west of Blue Ribbon Corner, to a sealed width of 20 feet.
---------------	--

CANN VALLEY HIGHWAY

ORBOST SHIRE	Widening, resheeting and curve improvement over 3·19 miles north of Cann River to provide a sealed width of 20 feet.
--------------	--



Glenelg Highway, Grenville Shire—Widening west of Ballarat.

GLENELG HIGHWAY

GRENVILLE SHIRE

Widening and realignment of 3.46 miles west of Ballarat to provide a sealed width of 24 feet.

MT. ROUSE SHIRE

Reconstruction of 4.9 miles east of Dunkeld to provide a sealed width of 24 feet.

WANNON SHIRE

Construction of a new bridge and approaches 0.75 mile in length with 24 feet wide sealed pavement, west of Coleraine.

GOULBURN VALLEY HIGHWAY

GOULBURN SHIRE

Widening and resheeting 4.29 miles at Murchison East to provide a sealed width of 24 feet.

SHEPPARTON CITY

Widening the bridge over the Broken River south of Shepparton from 22 feet to 28 feet wide between kerbs.

YEA SHIRE

Realignment and reconstruction of 1.67 miles at Box Hill cutting near Yea to a sealed width of 22 feet.

HAMILTON HIGHWAY

BANNOCKBURN SHIRE

Widening a section 0.5 mile in length through Inverleigh township to provide a sealed width of 24 feet.

HENTY HIGHWAY

WIMMERA SHIRE

Strengthening and surfacing shoulders over a distance of 5.6 miles north of Dooen to provide a sealed pavement 24 feet wide.

WARRACKNABEAL SHIRE

Widening and resheeting sections totalling 4.0 miles north of Kellalac to a sealed width of 24 feet.

KARKAROOC SHIRE

Widening the pavement north of Hopetoun over a distance of 3.2 miles to a sealed width of 24 feet.

KIEWA VALLEY HIGHWAY

YACKANDANDAH SHIRE

Reconstruction of 2.85 miles near Dederang to provide a widened pavement with a sealed width of 22 feet.

MAROONDAH HIGHWAY

ALEXANDRA SHIRE

Reconstruction of 1.56 miles south of Buxton to provide a sealed width of 24 feet.

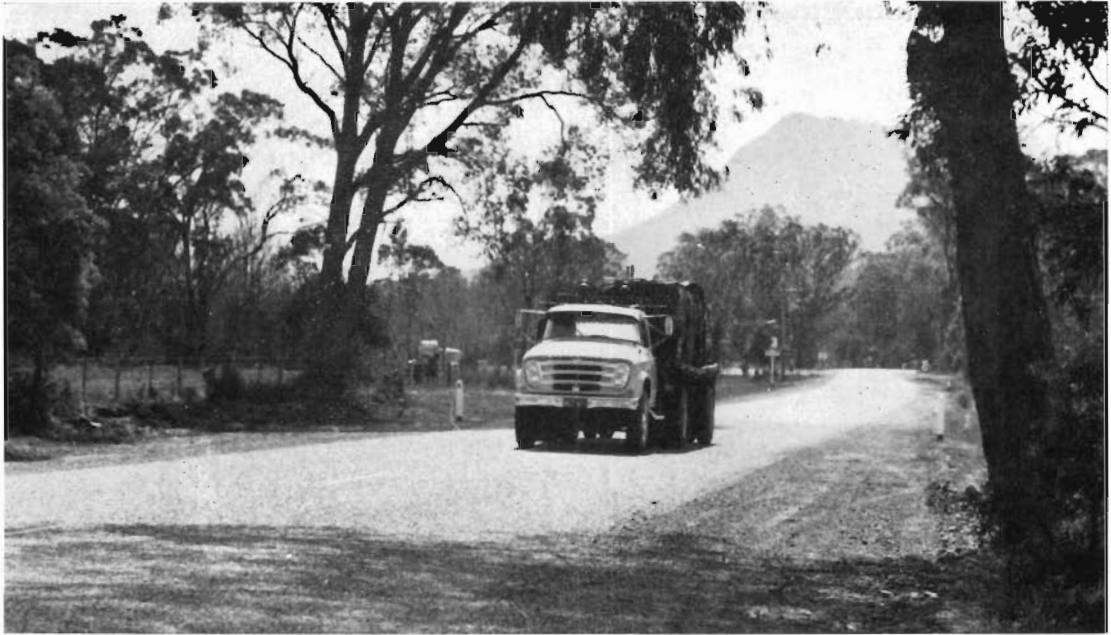

Maroondah Highway, South of Buxton—Alexandra Shire.

MIDLAND HIGHWAY

BANNOCKBURN SHIRE

Improvement and realignment of the curve at the intersection with the Gheringhap-Fyansford road.

Elimination of the railway level crossing at Gheringhap by the construction of a road over rail overpass.

Reconstruction of 1.5 miles south of Meredith to provide a sealed width of 24 feet.

BALLARAT CITY

Construction of dual carriageways 0.23 mile in length and a channelized intersection in Creswick Road, Ballarat.

CRESWICK SHIRE

Reconstruction of 1.15 miles of a section at Springmount, south of Creswick, to a sealed width of 24 feet.

BENALLA AND MANSFIELD SHIRES

Construction of a deviation 4.5 miles in length near the Nillahcootie Dam, in conjunction with the State Rivers and Water Supply Commission.

Construction of a three span reinforced concrete bridge 237 feet long and 28 feet between kerbs over Sandy Creek on a new deviation.

ALBERTON SHIRE

Widening 0.7 mile south of the Grand Ridge Road, approximately seven miles north of Welshpool.

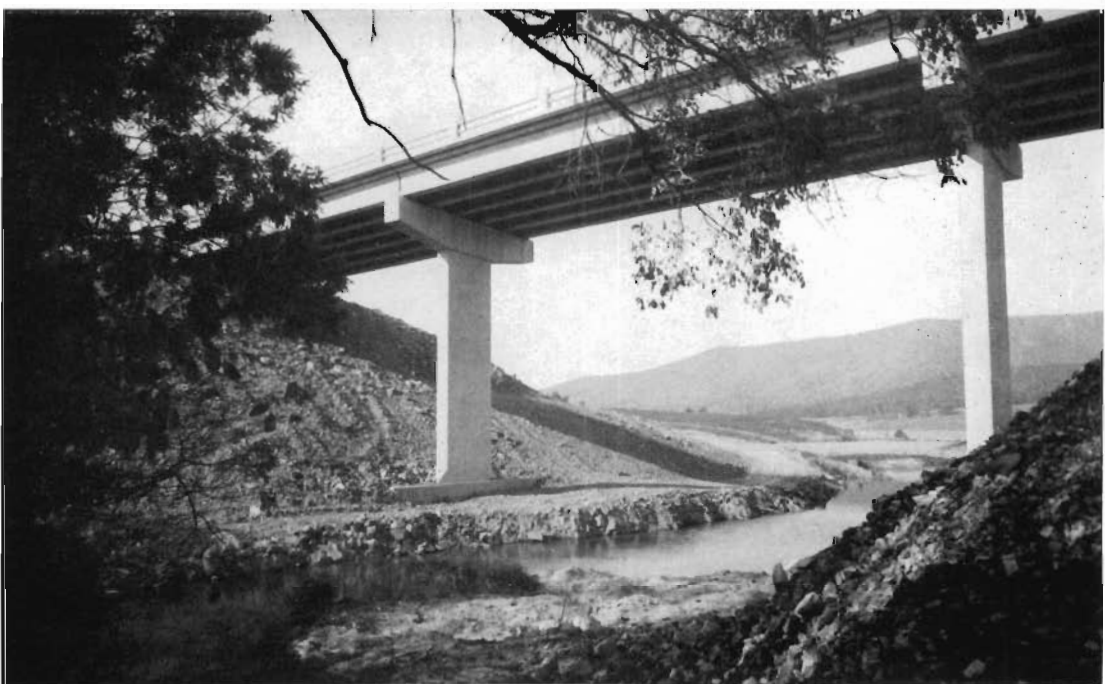

Three span reinforced concrete bridge over Sandy Creek on the Nillahcootie deviation.

MURRAY VALLEY HIGHWAY

UPPER MURRAY SHIRE

Reconstruction of 4.1 miles between Pine Mountain Creek and Tintaldra to a sealed width of 20 feet.

Widening and resheeting including lime stabilization of 5.0 miles west of Echuca to provide a 24 feet wide sealed pavement.

SWAN HILL SHIRE

Realignment at the Pental railway level crossing and installation of flashing lights.

Reconstruction of 6.5 miles of unsealed pavement east of Wemen to provide an 18 feet wide sealed pavement.

NORTHERN HIGHWAY

KILMORE SHIRE

Reconstruction of a further 1.35 miles towards the Hume Highway junction to a sealed width of 24 feet.

WANNON SHIRE

Realignment, regrading and resheeting of 2.91 miles south of Toolleen to provide a sealed width of 24 feet.

ROCHESTER SHIRE

Construction of a multi cell reinforced concrete culvert north of Rochester and raising the road formation over 0.24 mile to a sealed width of 24 feet.

NORTH WESTERN HIGHWAY

AVOCA SHIRE

Construction of a new reinforced concrete bridge 235 feet long and 28 feet wide between kerbs over the Avoca River at Vale of Avoca with realigned approaches 1.08 miles long to a sealed width of 24 feet.

DONALD SHIRE

Strengthening shoulders over 4.2 miles between Massey and Watchem.

BIRCHIP SHIRE

Strengthening shoulders over 3.0 miles south of Birchip.

Reconstruction of 0.56 mile to a sealed width of 40 feet in Birchip.



North Western Highway—New bridge over the Avoca River at Vale of Avoca—Avoca Shire.

OMELO HIGHWAY

TAMBO SHIRE

Replacement of timber bridges with pipe culverts at Bark Shed Creek, Bullocky Creek, Double Bridges, Pig and Whistle and Smokey Creek.

Widening the road formation over 2.8 miles south of Glen Valley.



Ovens Highway—New bridge and approaches at Burgoigee Creek.

OUYEN HIGHWAY

WALPEUP SHIRE

Reconstruction of the gravel pavement over 6.37 miles between Cowangie and Danyo to provide a sealed width of 18 feet.

OVENS HIGHWAY

BEECHWORTH SHIRE

Construction of a new bridge and approaches at Burgoigee Creek.

PYRENEES HIGHWAY

TULLAROOP SHIRE

Widening resheeting and reconstruction of 3.7 miles at Moorlort to a sealed width of 24 feet.

Widening the reinforced concrete bridge over Deep Creek at Carisbrook to 28 feet wide between kerbs, and a footway.

SOUTH GIPPSLAND HIGHWAY

CRANBOURNE SHIRE

Widening and resheeting 0.65 mile north of Cranbourne to a sealed width of 24 feet, and construction of 0.45 mile of dual carriageways in Cranbourne township.

SOUTH GIPPSLAND SHIRE

Reconstruction and realignment of 1.4 miles between Meeniy and Foster to a sealed width of 22 feet.

Construction of the Foster deviation 1.7 miles in length to a 22 feet wide sealed width and an additional climbing lane on a steep section.

ALBERTON SHIRE

Widening and strengthening 1.3 miles east of Yarram to provide a sealed width of 24 feet.

WARBURTON HIGHWAY

UPPER YARRA SHIRE

Reconstruction of 1.6 miles at Wandin North to provide a sealed width of 24 feet.

WIMMERA HIGHWAY

WIMMERA SHIRE

Shoulder strengthening and surfacing over 4 miles west of Horsham to provide a sealed width of 20 feet.

KOWREE SHIRE

Widening 0.85 mile between Kaniva Road turn-off and Edenhope to provide a sealed width of 24 feet.

Raising formation and widening pavement west of Edenhope over a distance of 2.1 miles to provide a sealed width of 24 feet.

DUNMUNKLE SHIRE

Priming and sealing 6.8 miles of pavement between Murtoa and Rupanyup to a width of 24 feet.

APPENDIX 2

TOURISTS' ROADS AND FOREST ROADS

SIGNIFICANT WORKS CARRIED OUT DURING FINANCIAL YEAR 1966/67

TOURISTS' ROADS

ACHERON WAY	Construction of a new bridge and approaches (Signs Bridge) in Warburton at the junction with the Warburton-Woods Point Road.
ALPINE ROAD	Major realignment over a distance of 1.71 miles between Horsehair Plain and Redbank with a pavement 24 feet wide.
GRAMPIANS ROAD	Widening and resheeting 2 miles between Halls Gap and the Lake Bellfield deviation.
MALLACOOTA ROAD	Realignment of 0.79 mile subsequent to bridge replacement at Temple's to complete the sealing of the road to a width of 18 feet.



Mount Buffalo Road—A "freeze-thaw" resistant pavement at road level 4000 feet.

MOUNT BUFFALO ROAD	Construction of the pavement with bitumen penetrated crushed rock to resist freeze-thaw conditions over a distance of 3 miles. Construction of a deviation at Cresta with a 24 feet wide pavement.
MOUNT DONNA BUANG ROAD	Widening 1.25 miles between Cement Creek and the 10 mile turntable and sealing to a width of 22 feet to complete the sealing of the road to the turntable.
MOUNT VICTORY ROAD	Replacement of an old timber bridge over the McKenzie Creek with a reinforced concrete bridge 92 feet long and 24 feet wide between kerbs.
WILSON'S PROMONTORY ROAD	Reconstruction of 1.2 miles of road in the National Park north from Tidal River to a sealed width of 20 feet.
OCEAN ROAD	Reconstruction and sealing of 0.5 mile west of Torquay to provide a sealed width of 24 feet. Reconstruction of 1.4 miles at Anglesea between Four Kings and Sunnymead. Reconstruction and realignment involving heavy earth works of 1.56 miles at Yuulong.

FOREST ROADS

GREENDALE-TRENTHAM
ROAD

Construction of a new bridge 150 feet long and 24 feet wide between kerbs over the Lerderderg River at Blackwood together with realigned approaches 0·5 mile long.

TATONG-TOLMIE ROAD

Reconstruction of 1·7 miles to Fords Bridge completing the road with a sealed width of 18 feet.

WALHALLA ROAD

Widening and curve improvement over 1·2 miles south of the Aberfeldy River. The 10 feet wide formation was widened to 24 feet.

FORREST-APOLLO BAY
ROAD

Reconstruction of 1·0 mile under municipal control at the Devils Elbow near Barramunga.

LAVERS HILL-COBDEN
ROAD

Construction of 1·5 miles and extension of the sealed section by 1·5 miles.



New bridge on Ramrod Flat Road over the Tambo River—Shire of Tambo.

APPENDIX 3

MAIN ROADS

SIGNIFICANT WORKS COMPLETED DURING FINANCIAL YEAR 1966/67

BAIRNSDALE DIVISION

OMEBO SHIRE

Combienbar Road—Construction of 2·84 miles to a sealed width of 18 feet to connect Club Terrace with the Princes Highway East.

TAMBO SHIRE

Ramrod Flat Road—Construction of a new three span reinforced concrete bridge 215 feet long by 28 feet wide between kerbs over the Tambo River.

Construction of the approaches to the Tambo River and Little River bridges to complete the reconstruction of the road.



Ballan Road—Daylesford and Glenlyon Shire, reconstructed section.

BALLARAT DIVISION

ARARAT SHIRE

Ararat-Warrnambool Road—Reconstruction and realignment to a sealed width of 20 feet of three sections totalling 4·0 miles between Ross bridge and Lake Bolac.

Maroona-Glenhompson Road—Reconstruction and realignment of 1·50 miles north of Glenhompson to provide a sealed width of 20 feet.

DAYLESFORD AND GLENLYON SHIRE

Ballan Road—Reconstruction and realignment of 1·0 mile at Sailor's Falls to a sealed width of 20 feet.

GRENVILLE SHIRE

Cape Clear-Rokewood Road—Construction of a three span reinforced concrete bridge 90 feet long and 24 feet wide between kerbs over Mt. Misery Creek.

BENALLA DIVISION

BEECHWORTH SHIRE
BENALLA SHIRE
BRIGHT SHIRE
NUMURKAH SHIRE
TOWONG SHIRE
UPPER MURRAY SHIRE
YACKANDANDAH SHIRE

Beechworth Road—Reconstruction of 1·1 miles with initial sealing to a width of 20 feet.
Swanpool Road—Reconstruction of 2·3 miles with initial sealing to a width of 20 feet.
Bright-Tawonga Road—Reconstruction and widening of 4·2 miles in two sections to a sealed width of 21 feet.
Nathalia-Katamatite Road—Construction of Stoley's Bridge and approaches.
Yabba Road—Reconstruction of 1·7 miles in two sections including initial seal to a width of 20 feet.
Upper Murray Road—Continuation of reconstruction of 3·3 miles commenced in 1965/66 to a sealed width of 18 feet.
Dederang Road—Reconstruction and realignment of 2 miles to a sealed width of 18 feet.
Yackandandah-Wodonga Road—Reconstruction and realignment of three sections totalling 2·35 miles to a sealed width of 20 feet.



Nathalia-Katamatite Road—Numurkah Shire—Stoley's Bridge.



Dederang Road—Yackandandah Shire—Reconstructed section.

BENDIGO DIVISION

DEAKIN SHIRE	Echuca-Kyabram Road—Widening 3·41 miles and sealing to a width of 20 feet.
EAST LODDON SHIRE	Bendigo-Pyramid Road—Widening 4·5 miles and sealing to a width of 22 feet.
GORDON SHIRE	Bendigo-Pyramid Road—Reconstruction of 1·5 miles and sealing to a width of 20 feet. Boort-Kerang Road—Reconstruction of 1·5 miles and sealing to a width of 20 feet. Pyramid-Leitchville Road—Construction of 3·0 miles and sealing to a width of 20 feet.
KERANG SHIRE	Koondrook-Murrabit Road—Reconstruction of 10·45 miles and sealing to a width of 18 feet.
KORONG SHIRE	Wedderburn-Logan Road—Construction of a reinforced concrete bridge 150 feet long and 24 feet wide between kerbs and approaches at Fentons Creek.
MALDON SHIRE	Castlemaine-Maldon Road—Construction of a reinforced concrete bridge 100 feet long and 28 feet wide between kerbs over Muckleford Creek.
ROCHESTER SHIRE	Bamawm North Road—Reconstruction of 2·3 miles to a sealed width of 20 feet. Rochester - Bamawm - Prairie Road—Reconstruction and widening of 4·53 miles to a sealed width of 20 feet.
RODNEY SHIRE	Lancaster-Mooroopna Road—Reconstruction and primer sealing of 2·02 miles to a sealed width of 22 feet.
STRATHFIELDSAYE SHIRE	Bendigo-Sutton Grange Road—Construction and gravelling of 1·0 mile.
SWAN HILL SHIRE	Annuello-Wemen Road—Reconstruction of 3·6 miles and sealing 6·4 miles to a width of 12 feet. Robinvale Road—Reconstruction of 4·4 miles to a sealed width of 20 feet. Ultima Road—Reconstruction of 2·0 miles to a sealed width of 20 feet.



Robinvale Road—Reconstructed section 20 feet wide—Shire of Swan Hill.

WALPEUP SHIRE	Ouyen-Piangil Road—Widening of 3·0 miles and sealing to a width of 20 feet.
WARANGA SHIRE	Goornong-Murchison Road—Widening and sealing of 4·3 miles to a sealed width of 20 feet.
WYCHEPROOF SHIRE	Berriwillock-Woomelang Road—Reconstruction and sealing of 3·25 miles to a sealed width of 12 feet. Birchip-Sea Lake Road—Reconstruction and sealing of 3·42 miles to a sealed width of 12 feet. Birchip-Wycheproof Road—Reconstruction and sealing of 2·65 miles to a sealed width of 20 feet. Culgoa-Lalbert Road—Reconstruction and sealing of 2·79 miles to a sealed width of 12 feet.

DANDENONG DIVISION

BERWICK SHIRE
(Joint with Cranbourne Shire)

Ballarto Road—Reconstruction of 1·4 miles south of Pakenham East.

ELTHAM SHIRE

Eltham-Yarra Glen Road—Construction of the approaches to the bridge over the Plenty River.

FRANKSTON CITY

Dandenong-Frankston Road—Construction of dual carriage-ways for 1·8 miles between Skye Road and Seaford Road.

HASTINGS SHIRE

Baxter-Tooradin Road—Reconstruction of 0·75 mile easterly from Baxter.

HEALESVILLE SHIRE

Yarra Glen-Glenburn Road—Realignment and reconstruction of 1·52 miles to provide a 22 feet wide pavement.

Buxton-Marysville Road—Realignment and reconstruction of 1·0 mile north easterly from Marysville.

MORNINGTON SHIRE

Mornington-Dromana Road—Reconstruction of 0·4 mile between King Street and Fisherman's Beach.

RINGWOOD CITY
(Joint with Doncaster &
Templestowe City)

Ringwood-Warrandyte Road—Reconstruction of 0·6 mile northerly from Oban Road.

SHERBROOKE SHIRE

Wellington Road—Construction of 3·0 miles easterly from Logan Park Road.

SPRINGVALE CITY

Springvale Road—Reconstruction of 0·6 mile between Pillars Road and Wells Road.

WAVERLEY CITY

Springvale Road—Intersection treatment at High Street Road.

WHITTLESEA SHIRE

Epping Road—widening of 1·0 mile at Thomastown.

GEELONG DIVISION

BACCHUS MARSH SHIRE

Geelong-Bacchus Marsh Road—Widening of Maddingley Bridge and 2·0 miles of road widening and resheeting to provide a sealed width of 18 feet.

Gisborne Road—Construction of a new bridge at Darley.

BANNOCKBURN SHIRE

Meredith-Mt. Mercer Road—Reconstruction and sealing of 1·5 miles to complete the sealing of this road.

BARRABOOL SHIRE

Barrabool Road—Widening and sealing of 2·2 miles to provide a sealed width of 18 feet.

Anglesea Road—Reconstruction and sealing of 0·8 mile to provide a sealed width of 24 feet.

BELLARINE SHIRE

Geelong-Portarlington Road—Widening and sealing of 1·6 miles.

Portarlington-Queenscliffe Road—Channelization of the Drysdale-St. Leonards Road intersection.

BULLA SHIRE

Melbourne-Lancefield Road—Widening, reconstruction and sealing of 2·8 miles to provide a sealed width of 18 feet.

COLAC CITY

Colac-Beech Forest Road—Reconstruction of 0·3 mile to provide a sealed width of 40 feet.

COLAC SHIRE

Corangamite Lake Road—Reconstruction of 1·5 miles.

CORIO SHIRE

Geelong-Bacchus Marsh Road—Widening the bridge over Little River and construction of approaches.

GISBORNE SHIRE

Bacchus Marsh Road—Reconstruction and sealing of 1·0 mile to provide a sealed width of 18 feet.

KYNETON SHIRE
(Joint Newham and Woodend)

Tylden-Woodend Road—Construction of Harpers Bridge 90 feet long and 24 feet wide between kerbs together with approaches.

LEIGH SHIRE

Rokewood-Shelford Road—Widening and sealing of 6·6 miles to provide a sealed width of 18 feet.

Colac-Ballarat Road—Construction of Casey's bridge 45 feet long and 28 feet wide between kerbs and realignment at Corindhap.

MELTON SHIRE

Coimadai-Diggers Rest Road—Realignment of 0·8 miles including the approaches to Burkes Bridge.

Keilor-Melton Road—Reconstruction and sealing of 1·6 miles to provide a sealed width of 24 feet.



Yarra Glen-Glenburn Road—Board's plant at work—Shire of Healesville.



Darley Bridge on Gisborne-Bacchus Marsh Road—Over the Lerderderg River—Shire of Bacchus Marsh.

OTWAY SHIRE

Charleys Creek Road—Sealing of 1·2 miles to complete a sealed road between Colac and Beech Forest.

ROMSEY SHIRE

Melbourne-Lancefield Road—Widening of the bridge at Bolinda Vale and 2·0 miles of road.

SOUTH BARWON SHIRE

Barrabool Road—Widening and reconstruction of 1·0 mile between the Barwon River Bridge and Princes Bridge.

Barwon Heads Road—Completion of a new bridge over Waurm Ponds Creek.

WINCHELSEA SHIRE

Birregurra-Forrest Road—Completion of a new bridge over Barwon River.

Winchelsea-Dean Marsh Road—Completion of a new bridge over Retreat Creek.

HORSHAM DIVISION

BIRCHIP SHIRE	Birchip-Warracknabeal Road—Reconstruction and widening of 3·8 miles to a sealed width of 18 feet.
KARA KARA SHIRE	Charlton Road—Realignment and reconstruction of 3·55 miles to a sealed width of 18 feet.
KOWREE SHIRE	Apsley-Natimuk Road—Widening of 4·55 miles of the pavement to a sealed width of 18 feet. This completes the widening to an 18 feet sealed pavement over the whole of the road. Kaniva-Edenhope Road—Widening of 5·0 miles of the pavement to provide a sealed width of 18 feet.
STAWELL SHIRE	Stawell-Warracknabeal Road—Construction of Newington Bridge and its approaches. A two span reinforced concrete bridge 50 feet long and 26 feet wide between kerbs with 1 mile of approaches having a sealed width of 20 feet.
WIMMERA SHIRE	Horsham-Lubeck Road—Widening of 4 miles to complete the sealing of this road to a width of 18 feet in Wimmera Shire. Kalkee Road—Widening of 4·5 miles to provide a sealed width of 18 feet.



Charlton Road—Kara Kara Shire—Reconstructed section.

METROPOLITAN DIVISION

ALTONA SHIRE	Millers Road—Continuation of reconstruction to provide dual carriageways over 0·6 mile between Civic Parade and Kororoit Creek Road, including the construction of a second bridge over Kororoit Creek.
BRIGHTON CITY	South Road—Construction of the northern carriageway between New Street and Hampton Street, a distance of 0·55 mile, completing the dual carriageways between New Street, Brighton and Warrigal Road, Moorabbin.
CAMBERWELL CITY	Canterbury Road—Improvements to cross sections and the provision of superelevation on bends between Stanhope Grove and Gwenda Avenue. Warrigal Road—Reconstruction and widening between Thomas Street and Burwood Highway, a distance of 0·6 mile.
ESSENDON CITY (Joint Broadmeadows C.)	Pascoe Vale Road—Reconstruction and widening at Woodlands Street intersection.
FOOTSCRAY CITY	Hyde Street—Continuation of reconstruction to provide dual carriageways over 0·3 mile between Napier Street and Somerville Road.



Pascoe Vale Road—Reconstructed section at Woodlands Street intersection.

HAWTHORN CITY	Barkers Road—Reconstruction and widening between Auburn Road and Burke Road, a distance of 0·72 miles.
HEIDELBERG CITY	Heidelberg-Eltham Road—Reconstruction and widening between St. James Road and Lower Plenty Road, a distance of 0·8 mile.
KEILOR CITY	Lancefield Road—Completion of dual carriageways between Calder Highway and Parer Street, a distance of 0·8 mile.
KEW CITY	Studley Park Road—Continuation of reconstruction of 0·3 mile between High Street and The Boulevard.
MOORABBIN CITY	North Road—Continuation of reconstruction over 0·14 mile to provide dual carriageways between Grange Road and East Boundary Road.
OAKLEIGH CITY	North Road—Completion of reconstruction between Huntingdale Road and Princes Highway East, a distance of 0·9 mile. Doncaster-Mordialloc Road—Continuation of reconstruction and widening between Fern Tree Gully Road and Bourke Road, a distance of 0·41 mile.
PRESTON CITY	Whittlesea Road—Reconstruction to provide dual carriageways between Barwon Avenue and Curtain Street, a distance of 1·2 miles. The work included a second bridge over Darebin Creek.
SANDRINGHAM CITY	Beach Road—Continuation of the programme of improvements over 0·5 mile between New Street and Black Rock.
SUNSHINE CITY (Joint Essendon)	Raleigh's Road—Construction of a new bridge 478 feet long over the Maribyrnong River to carry road and tram traffic.
WILLIAMSTOWN CITY	Kororoit Creek Road—Continuation of reconstruction over 0·17 mile between Douglas Parade and the municipal boundary, including the provision of boom gates at the North Williamstown railway level crossing and the channelization of the intersection at Champion Road, Victoria Street and Swanston Street.

TRARALGON DIVISION

ALBERTON SHIRE

Yarram-Traralgon Road—Construction of 2·55 miles on the Lay's Road section to a sealed width of 18 feet.

Construction of a 3-cell Armco culvert at Bruthen Creek south of Carrajung to replace an old timber bridge.

Albert River-Welshpool Road—Reconstruction and realignment of 0·85 miles north west of Hedley.

MAFFRA SHIRE

Maffra-Newry Road—Reconstruction and realignment of 1·7 miles west of Maffra township to a sealed width of 18 feet.

MORWELL SHIRE

Morwell-Thorpdale Road—Construction of a four-span reinforced concrete bridge 28 feet wide to replace a narrow timber bridge over the Morwell River, south of Morwell.

WARRNAMBOOL DIVISION

DUNDAS SHIRE

Mount Napier Road—Reconstruction of 4·8 miles and sealing of 4 miles to a sealed width of 20 feet.

HEYTESBURY SHIRE

Cobden-Port Campbell Road—Reconstruction of 1·82 miles to a sealed width of 22 feet.

Cobden-Scotts Creek Road—Construction of a three span prestressed concrete bridge 120 feet long and 24 feet wide.

MORTLAKE SHIRE

Mortlake-Warrnambool Road—Construction of a five span prestressed beam bridge over the Hopkins River at Ellerslie.

MOUNT ROUSE SHIRE

Penshurst-Dunkeld Road—Widening and strengthening 4·0 miles to a sealed width of 20 feet.

PORTLAND SHIRE
(Joint Minhamite Shire)

Condah-Macarthur Road—Construction of a reinforced concrete bridge 99 feet long and 24 feet wide over Condah drain.

Dartmoor-Hamilton Road—Reconstruction of 4·4 miles to a sealed width of 22 feet.

WANNON SHIRE

Wannon Bridge—Construction of a seven span concrete bridge 307 feet long and 24 feet wide.

APPENDIX 4

UNCLASSIFIED ROADS

SIGNIFICANT WORKS COMPLETED DURING FINANCIAL YEAR 1966/67

BAIRNSDALE DIVISION

ORBOST SHIRE

Marlo-Cape Conran Road—(Special Project No. 14). Construction of 7·9 miles of new coastal road to a sealed width of 20 feet.

Combienbar and Errinundra Roads—Works west of Club Terrace to strengthen the roads for timber traffic including widening and strengthening 14 miles and the replacement of 13 bridges with 12 concrete and corrugated steel culverts and one new bridge.

TAMBO SHIRE

Basin Road—Construction of a new 6 feet diameter reinforced concrete pipe subway and 0·3 mile of roadway 2 miles east of Buchan.

Snowy River Road—Construction of a 1·2 mile deviation at Wulgulmerang north from Goodwin Creek.



Special Project No. 14—Marlo-Cape Conran Road—Shire of Orbost.

BALLARAT DIVISION

ARARAT SHIRE

Geelong Road—Construction of a three span reinforced concrete bridge 90 feet long and 24 feet wide between kerbs over the Hopkins River.

Back Bolac Road—Reconstruction of 3·1 miles to a sealed width of 12 feet.

BUNINYONG SHIRE

Buninyong-Sebastopol Road—Reconstruction and sealing of 1·1 miles with two new major culverts to a sealed width of 22 feet.

RIPON SHIRE

Kayley's Lane—Reconstruction of 2·0 miles south of the Western Highway to a sealed width of 12 feet.

BENALLA DIVISION

BRIGHT SHIRE

Dargo High Plains Road—Reforming and regravelling 9·9 miles.

MANSFIELD SHIRE

Mount Buller extension Road—Construction and sealing of the car park at skating rink as an experimental freeze-thaw pavement.

Oliver's Lane—Reconstruction and sealing of 1·3 miles to a sealed width of 18 feet.

Mansfield-Howes Creek Road—Realignment and reconstruction of 1·0 mile with a 20 feet wide pavement.

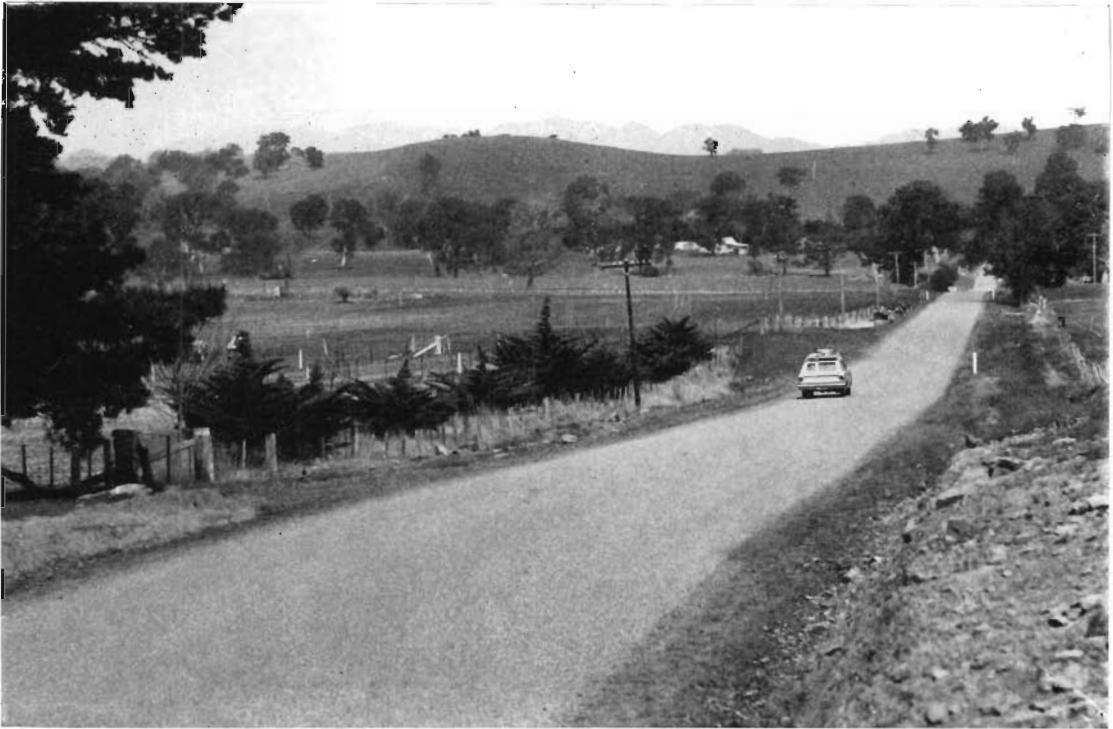

Olivers Lane—Mansfield Shire—Reconstructed section.

NATHALIA SHIRE	Nathalia-Barmah Road—Construction and initial sealing of 1·1 miles to a sealed width of 18 feet.
NUMURKAH SHIRE	Baulkamaugh Hall Road—Strengthening and sealing to a width of 18 feet.
SHEPPARTON SHIRE	Doyles Lane and River Road—Reconstruction and initial sealing of 1·91 miles to a sealed width of 20 feet.
TOWONG SHIRE	Mitta North Road—Reconstruction and initial sealing over 2·71 miles to a sealed width of 18 feet.
UPPER MURRAY SHIRE	Benambra-Corryong Road—Construction of Staceys Bridge 55 feet long and 22 feet wide between kerbs over Nariel Creek.
	Construction of Willow Crossing Bridge, 136 feet long and 22 feet wide between kerbs.
YACKANDANDAH SHIRE	Sandy Creek Road—Construction of a two span bridge 50 feet long and 22 feet wide between kerbs over Sandy Creek.



Baulkamaugh Hall Road—Strengthened and sealed to a width of 18 feet.

BENDIGO DIVISION

BENDIGO CITY	Baxter Street—Construction of a reinforced concrete bridge over Bendigo Creek 54 feet long and 30 feet wide between kerbs with 7 feet 6 inches wide footpaths.
COHUNA SHIRE	Mead Road—Construction and initial sealing of 1·8 miles to a sealed width of 18 feet.
DEAKIN SHIRE	Tongala Central M.S.—Reconstruction and initial sealing of 2·54 miles to a sealed width of 12 feet.
EAST LODDON SHIRE	Dalziel's Road—Construction of a bridge over Serpentine Creek 81 feet long and 21 feet 6 inches wide between kerbs.
ECHUCA CITY	McKinlay Street—Reconstruction and initial sealing of 0·72 mile to a sealed width of 36 feet.
KERANG SHIRE	Benjeroop-Lake Charm Road—Reconstruction of 1·7 miles.
KORONG SHIRE	Hurstwood School Road—Construction of a reinforced concrete bridge 142 feet long and 22 feet wide between kerbs.
METCALFE SHIRE	Redesdale-Sutton Grange Road—Reconstruction and graveling of 5·3 miles to sealed widths of 12 and 20 feet.
MILDURA SHIRE	Meringur North Road—Reconstruction and gravelling of 6·45 miles to a sealed width of 12 feet.
ROCHESTER SHIRE	Diggorra Road—Reconstruction and gravelling of 3·33 miles.
RODNEY SHIRE	Murchison-Toolamba-Mooroopna Road—Reconstruction and sealing of 5·2 miles to a sealed width of 22 feet.
SWAN HILL SHIRE	Pental Island Road. Construction of a reinforced concrete prestressed beam bridge 201 feet long and 22 feet wide between kerbs.

DANDENONG DIVISION

CRANBOURNE SHIRE	Denham's Road—Reconstruction of 0·7 mile westerly from the Koo-Wee-Rup Longwarry Road.
DANDENONG CITY	McCrae Street—Construction of dual carriageways 0·3 mile in length between Power Street and Foster Street.
ELTHAM SHIRE	Research-Warrandyte Road—Reconstruction of 0·6 mile north of Stoney Creek.
KNOX SHIRE	Boronia Road—Reconstruction of 1·4 miles between Stud Road and Scoresby Road.
NUNAWADING CITY	Springvale Road—Construction of dual carriageways 0·3 mile in length between Maroondah Highway and Springfield Road.
SHERBROOKE SHIRE	Glenfern Road—Reconstruction of 0·4 mile between George Street and Glenfern Avenue.
SPRINGVALE CITY	Lower Dandenong Road—Reconstruction of 1·0 mile easterly from Doncaster-Mordialloc Road.
WAVERLEY CITY	Blackburn Road—Reconstruction of 0·8 mile between High Street Road and Highbury Road.

GEELONG DIVISION

BACCHUS MARSH SHIRE (Joint Corio Shire)	McArthurs Road—Construction of McArthurs Bridge. Brisbane Road—Reconstruction and sealing of 1·5 miles to complete the reconstruction of this road.
BELLARINE SHIRE	St. Leonards-Bluff Road—Reconstruction and sealing between St. Leonards and the Bluff.
GEELONG CITY	Weddell Road—Reconstruction and sealing between Victoria Street (Corio Shire) and the Midland Highway (City of Geelong West).
KYNETON SHIRE	Kyneton-Baynton Road—Reconstruction and sealing to complete the full length of the road.
LEIGH SHIRE	Winchelsea-Doroq Road—Sealing to complete the full length of the road.
NEWTOWN & CHILWELL	Fyans Street—Reconstruction between Shannon Avenue and Pakington Street.
OTWAY SHIRE	Carlisle-Colac Road—Reconstruction and sealing of 1·6 miles.

SOUTH BARWON SHIRE	Boundary Road—Construction and sealing between Torquay Road and Barwon Heads Road. Barwon Heads-Torquay Road—Construction and sealing of 2·0 miles to Black Rock.
WERRIBEE SHIRE	Ballan Road—Sealing of 3·5 miles of previously reconstructed pavement. Bulban Road—Reconstruction and sealing of 2·8 miles.
WINCHELSEA SHIRE	Cape Otway Road—Reconstruction and sealing of 1·7 miles.
HORSHAM DIVISION	
DIMBOOLA SHIRE	Salisbury-Woorak Road—Construction and initial sealing of 0·85 mile.
KANIVA SHIRE	A.M.P. Big Desert Development—Construction of Service-ton North Road and Murrawong North Road totalling 10·1 miles.
LOWAN SHIRE	A.M.P. Big Desert Development—Construction of 2·3 miles of Millers Road.
KARA KARA SHIRE	Baldwin's Plains Road—Construction of Baldwins Bridge, a three span reinforced concrete bridge 80 feet long and 20 feet wide between kerbs on a new alignment.
KOWREE SHIRE	Harrow-Clear Lake Road—Construction and initial sealing of 3·21 miles to a sealed width of 12 feet completing the sealed pavement on the road.
STAWELL SHIRE	Glynwylln-Morrl Morrl Road—Construction of Glynwylln Bridge over the Wimmera River, a three span reinforced concrete bridge 181 feet long and 22 feet wide between kerbs. Stawell-Joel South Road—Construction of Frampton's Bridge over the Wimmera River, a three span bridge 135 feet long and 22 feet wide between kerbs.
METROPOLITAN DIVISION	
ALTONA SHIRE	Mason Street—Continuation of the construction of dual carriageways between Mills Road and Hansen Street.
BOX HILL CITY	Highbury Road—Reconstruction and widening of 0·3 mile between Warrigal Road and Doncaster-Mordialloc Road. Station Street—Reconstruction and widening of 0·5 mile northerly from the Maroondah Highway.
BRUNSWICK CITY	Glenlyon Road—Reconstruction of 0·95 mile between Nicholson Street and Sydney Road.
CAMBERWELL CITY	Bulleen Road—Reconstruction and widening between Doncaster Road and Thompsons Road, a distance of 0·95 mile. Burke Road—Construction of a new duplicate bridge over the Yarra River with approaches (Joint with Cities of Heidelberg and Kew).
COBURG CITY	Bell Street—Reconstruction of 0·2 mile between Cumberland Road and Hackett Street.
FOOTSCRAY CITY	Whitehall Street—Reconstruction of 0·7 mile between Napier Street and Youell Street. Hopkins Street—Reconstruction to provide dual carriageways for 0·3 mile between Moreland Road and Moore Street.
KEW CITY	Harp Road—Reconstruction and widening of 0·25 mile between High Street and Burke Road.
MOORABBIN CITY	Nepean Highway—Construction of service roads in various sections totalling 0·8 mile.
NORTHCOTE CITY	Grange Road—Reconstruction of 0·25 mile between Wingrove Street and Darebin Road.
OAKLEIGH CITY	Centre Road—Reconstruction and widening of 0·5 mile between Doncaster-Mordialloc Road and the municipal boundary.
SOUTH MELBOURNE CITY	Canterbury Road—Reconstruction and duplication between Frazer Street and Mills Street.

ST. KILDA CITY

Albert Park—Reconstruction of parts of Queens Road Drive and Aughtie Drive north of Fitzroy Street.

WILLIAMSTOWN CITY

Melbourne Road—Reconstruction of 0.53 mile between Newport overpass and The Avenue.



Albert Park Roads—Aughtie Drive and Queens Road Drive—City of St. Kilda.

TRARALGON DIVISION

ALBERTON SHIRE

Pound Road East—Construction of a three span reinforced concrete bridge over the flood channel of the Tarra River on improved alignments.

NARRACAN SHIRE

Early Road—Reconstruction and realignment of 1.4 miles.

SOUTH GIPPSLAND SHIRE

Foster-Promontory Road—Realignment and regrading of 0.64 miles of the approaches to the railway level crossing south of Foster to improve visibility.

ROSEDALE SHIRE

Seacombe-Spermwhale Head Road—Reconstruction and sealing of 3.0 miles to provide a sealed width of 12 feet.

WARRNAMBOOL DIVISION

DUNDAS SHIRE

Nigretta Road—Construction of a five span prestressed concrete beam bridge 201 feet long and 24 feet wide over the Wannan River.

MORTLAKE SHIRE

Woorndoo-Streatham Road—Reconstruction of 5.23 miles to provide a sealed width of 16 feet.

APPENDIX 5

MOTOR REGISTRATION

Registration effected during the year under the Motor Car act totalled 1,221,352, an increase of 4·4 per cent, on the registrations effected during the previous year as compared with an increase in 1965/66 of 4·7 per cent over the total for 1964/65.

Vehicle	Financial Year 1965/66	Financial Year 1966/67	Increase	Decrease
Private—				
New	87,777	87,996		
Secondhand—				
Re-registered	26,479	28,869		
Renewals	815,738	855,709		
	<u> </u>	<u> </u>	42,580	
Commercial and Hire—				
New	13,876	13,596		
Secondhand—				
Re-registered	3,912	4,342		
Renewals	107,101	110,284		
	<u> </u>	<u> </u>	3,333	
Primary Producers—Trucks—				
New	5,136	5,176		
Secondhand—				
Re-registered	3,982	4,563		
Renewals	72,179	74,378		
	<u> </u>	<u> </u>	2,820	
	81,297*	84,117†		
Licences under Motor Omnibus Act	792	792	—	
Trailers	18,767	22,934	4,167	
Motor Cycles	12,100	12,713	613	
	<u> </u>	<u> </u>	<u> </u>	<u> </u>
TOTAL	1,167,839	1,221,352	53,513	—

* Includes 40,797 No Fee Tractors.

† Includes 42,594 No Fee Tractors.

APPENDIX 6

COUNTRY ROADS BOARD. STATEMENTS OF RECEIPTS AND PAYMENTS FOR YEAR ENDED 30TH JUNE, 1967. (Adjusted to nearest dollar.)

	Country Roads Board Fund		Loan Funds	Commonwealth Aid Roads				Total
	Act 6229	Act 6222 Road Maintenance Account		Act 1964 Sec. 5 (1)	Act 1964 Sec. 5 (2)			
RECEIPTS	\$	\$	\$	\$	\$	\$	\$	\$
Balance as at 1st July, 1966		1,079,532						1,079,532
Motor Car Act 1958 (No. 6325)								
Motor Car Registration Fees	25,980,429							
Additional Registration Fees	1,586,907							
Drivers' Licence Fees	676,829							
Drivers' Licence Testing Fees	197,765							
Examiners' Licence Fees	8,406							
Sale of Log Books	5,060							
	28,455,396							
Less Cost of Collection	2,583,907							
		25,871,489					25,871,489	
Municipalities Repayments—								
Permanent Works—Main Roads	90,676							
Maintenance Works—Main Roads	1,733,282							
		1,823,958					1,823,958	
Commercial Goods Vehicles Act No. 6222			6,732,313					6,732,313
Public Works Loan Application Act No. 7504		714,920						714,920
Fees and Fines—Country Roads Act No. 6229		1,091						1,091
General Receipts		457,602						457,602
State Loan Funds Act No. 6229				833,520				833,520
Commonwealth Aid Roads Act 1964					17,273,026	11,777,063		29,050,089
		29,948,592	6,732,313	833,520	17,273,026	11,777,063		66,564,514
PAYMENTS								
Road Expenditure								
Main Roads—								
Construction and Reconstruction		8,415,471		398,299	3,602,062		12,415,832	
Maintenance		2,167,932	2,171,731		10,004		4,349,667	
							16,765,499	
State Highways—								
Construction and Reconstruction		3,624,426		435,221	8,406,136		12,465,783	
Maintenance		128,825	4,560,582				4,689,407	
							17,155,190	
By-pass Roads—								
Construction and Reconstruction		2,356,090			2,232,465		4,588,555	
Maintenance		112,174					112,174	
							4,700,729	
Tourists' Roads—								
Construction and Reconstruction		314,929			750,000	688,078	1,753,007	
Maintenance		558,515					558,515	
							2,311,522	
Forest Roads—								
Construction and Reconstruction						442,038	442,038	
Maintenance						295,048	295,048	
							737,086	
Unclassified Roads—								
Construction and Reconstruction					2,073,370	8,497,174	10,570,544	
Maintenance					51,776	1,854,725	1,906,501	
							12,477,045	
Murray River Bridges and Punts		44,949					44,949	
Traffic Line Marking		211,748					211,748	
Traffic Lights		40,200					40,200	
							54,443,968	
Statutory Payments								
Interest and Sinking Fund	2,140,461							
Tourist Fund	493,805							
Transport Regulation Fund	382,710							
Metropolitan Transportation Survey	28,552							
		3,045,528						3,045,528
Contribution to Australian Road Research Board					147,213			147,213
Capital Expenditure								
Plant Replacements and Additions	1,388,216							
Buildings, Workshops, etc.	165,304							
		1,553,520						1,553,520
Management and Operating Expenditure		5,074,487						5,074,487
		27,648,794	6,732,313	833,520	17,273,026	11,777,063		64,264,716
Balance at 30th June, 1967		2,299,798						2,299,798

NOTE.—Relief to Municipalities granted under Act 6229 Section 32 amounted in 1966/67 to \$41,505.20.

R. G. COOPER,
Accountant,
24th November, 1967.

AUDITOR-GENERAL'S CERTIFICATE

The accounts of the Country Roads Board for the year ended 30th June, 1967, have been audited. In my opinion the above Statement of Receipts and Payments fairly presents in summary form the transactions during that period.

A. J. A. GARDNER,
Auditor-General,
1st December, 1967.

APPENDIX 7

COUNTRY ROADS BOARD LOAN LIABILITY AS AT 30TH JUNE, 1967

	Main Roads, &c.	Development Roads	Total
	\$	\$	\$
Permanent Works			
Main Roads	16,096,183.36		16,096,183.36
State Highways	14,874,443.00		14,874,443.00
Tourists' Roads	227,316.44		227,316.44
Forest Roads	2,167.89		2,167.89
Developmental Roads		12,851,515.09	12,851,515.09
Discount and Expenses	589,414.40	546,076.16	1,135,490.56
Total Amount Borrowed	31,789,525.09	13,397,591.25	45,187,116.34
Less Redemption of Loans			
Redemption Funds	170,438.11	1,292,772.73	1,463,210.84
Mains Roads Sinking Fund	571,376.76		571,376.76
Developmental Roads Sinking Fund		110,166.02	110,166.02
State Loans Repayment Fund	2,765,556.85		2,765,556.85
National Debt Sinking Fund	4,656,289.57	5,084,458.60	9,740,748.17
	8,163,661.29	6,487,397.35	14,651,058.64
Loan Liability at 30th June, 1967	23,625,863.80	6,910,193.90	30,536,057.70

APPENDIX 8

WORKS EXECUTED ON BEHALF OF COMMONWEALTH AND STATE GOVERNMENT AUTHORITIES FOR THE YEAR ENDED 30th JUNE, 1967

Departments	Description of Works	Expenditure	
		\$	\$
<i>Commonwealth—</i>			
Department of Works	Access roads to various Commonwealth establishments and to Tullamarine Freeway	572,563.58	572,563.58
<i>Victoria—</i>			
State Rivers and Water Supply Commission	Construction of various bridges over Commission Channels, roadworks in connection with Lake Bellfield and Lake Nillahcootie Deviations	212,474.54	
Rural Finance and Settlement mission	Roads in Commission Land settlement projects throughout the State	147,553.51	
Housing Commission	Completion of roadworks in Seymour Housing Estate	2,669.88	
Lands and Survey Department	Roadworks in Benalla, Dundas, Glenelg, Kaniva and Lowan Shires	57,183.03	
Public Works Department	Roads in connection with fruit fly inspection stations in Nathalia and Cobram Shires	733.34	
Melbourne City Council	Roadworks and bridgeworks on Dynon Road Bridge over railway line and approaches	78,586.03	
Melbourne and Metropolitan Board of Works	Roadworks in Healesville Shire	4,201.79	
Railways Department	Realignment of Bloomfield Road bridge, Buln Buln Shire	1,773.23	
State Electricity Commission	Finalization of expenditure on Hernes Oak Deviation, Morwell Shire	272.64	
State Treasury	Kings Bridge—Sundry expenditure less receipts including proceeds of disposal and rental of properties acquired in connection with the construction of Kings Bridge	2,794.86	505,447.99
" "	Grade separation projects, etc., charged to Level Crossings Fund (\$214,486.70) and Railways Department (\$500,745.02)	715,231.72	
" "	Improvements to various roads adjacent to State forests to facilitate the extraction of timber and charged to the Municipalities Forest Roads Improvement Fund	22,347.81	
" "	Construction of roads and bridges charged to the Roads (Special Projects) Fund	3,310,762.04	4,051,136.43
			<u>5,129,148.00</u>

APPENDIX 9

CHIEF ENGINEER'S REPORT

Country Roads Board
Melbourne,
November 1967

THE CHAIRMAN,

Sir,

I have the honour to report on matters of technical interest carried out during the year 1966-67. The report is divided into four major subdivisions corresponding to the four sub-branches of the Chief Engineer's Branch, followed by some matters of a general engineering nature.

WORKS SUB-BRANCH

1. ROAD CONSTRUCTION AND MAINTENANCE

Planning of Major Works

The Board has been responsible in recent years for the construction of sections of urban freeway routes, e.g. the Tullamarine and Strathmore Bypass Roads, and the approaches to the Lower Yarra Crossing. Planning of pre-construction and construction work on such projects has been assisted by the use of linear programming methods, i.e. the Critical Path Method and Programme Evaluation Review Technique, abbreviated C.P.M. and P.E.R.T. A brief reference was made in the 1963-64 report to the use by the Board of these techniques for the planning and control of large intricate construction works. The use of these methods has considerably increased particularly when related to the pre-construction activities.

The problems are of the same nature as those found in the usual range of Board's work, but are of a greater magnitude and complexity. They include the necessity for:

- (a) completion by a relatively close target date
- (b) close co-ordination of the work of the Board's specialist groups on location, road and bridge design, right-of-way acquisition and clearance
- (c) co-ordination of the decisions to be made in connection with the above areas of work
- (d) co-operation with other public authorities whose requirements affect the projects.

The procedure in linear programming is to prepare a network diagram for a project, setting out in graphical form the steps necessary to completion, their sequence and dependence on other items. A time estimate for each item is added in sequence to "chains" or "paths" composed of related activities.

Adequate information for the network diagram can be obtained without excessive subdivision of the project. For example, the network diagram for pre-construction control of Tullamarine Bypass Road contained about 100 activities—about 90 for actual operations and about 10 "dummies" to provide logically for inter-relation of operations. This project contains 4.5 miles of four-lane divided carriageway, 4 miles of one- or two-lane one-way roads or ramps, 6.5 miles of two-lane two-way roads, and twelve small to medium bridges, and will cost about \$5,000,000. For the Strathmore Bypass Road the network diagram for pre-construction control contained about 140 activities including about 30 dummies. This project includes 2 miles of four-lane freeway, two major interchanges and eight medium to large bridges. A single activity was adequate, in the pre-construction stages, to represent each of the design, advertisement and construction phases of each of the roadworks contracts. A chain of only the five following activities—

site survey and plan providing vertical and horizontal alignment details

foundation investigation

detail design and plans and specifications

advertisement for, and acceptance of tenders

construction

was required to represent each bridge or group of adjoining identical or similar bridges.

Programme Evaluation Review Technique for the above networks, consisted of periodic reviews of the entire projects at intervals of 2-3 months after preparation of the original network diagram and time estimates. During these reviews, completion times for part-completed items are re-estimated, and other items are checked. Changes in the sequence of events shown in the network diagram are incorporated where necessary, and the duration of the critical and limiting paths, and the floats on the non-critical paths, are recalculated.

In the case of the Tullamarine Bypass Road programme, P.E.R.T. programming was terminated at the commencement of the final road and bridge construction contracts, because control by normal methods was considered adequate beyond this stage. For construction of the Strathmore Bypass Road, a network much more detailed than the pre-construction network has been prepared. It will assist in the control and co-ordination of the roadwork (which is to be carried out in one large contract) with work under several bridge contracts, and with the activities of other public authorities. This network contains about 320 activities, most of which are for actual construction by the Board's or other authorities' road and bridge contractors or direct labour gangs. A

review of the existing situation will be made at the end of each calendar month using the network, which will be modified, if necessary, as a result of actual progress of the activities and the actual methods of working.

The initial and review calculations are done on the Board's IBM 1620 computer. The output consists of a listing against each item of—

- (i) calendar starting and finishing dates for the item based on the estimated time to complete it
- (ii) the latest possible calendar dates for commencement and completion of the item, if the target completion date is to be met.

The items are usually listed in order of increasing float commencing with the critical path.

TABLE 1—DISTRIBUTION OF EXPENDITURE

	1966-67	Five Year Average 1962-63 to 1966-67
	%	%
Plant	36.1	34.3
Labour	33.2	32.4
Materials	21.8	24.4
Stores	8.9	8.9

TABLE 2—WORKS OVERHEAD EXPENDITURE
(Percentage of Productive Costs)

	1966-67	Five Year Average 1962-63 to 1966-67
	%	%
Construction overhead expenses	11.1	8.8
Camp expenses	15.2	17.6
	26.3	26.4

TABLE 3—FORMATION COSTS
(Including Distributed Overhead Expenditure)

	Rock		Earth Unclassified		Total	
	Quantity	Unit Cost	Quantity	Unit Cost	Quantity	Unit Cost
1966-67	cu. yds.	\$	cu. yds.	\$	cu. yds.	\$
Five year average 1962-63 to 1966-67	246,182	1.41	1,197,579	1.00	1,443,761	1.07
	120,389	1.39	1,213,390	1.06	1,333,779	1.10

TABLE 4—PAVEMENT MATERIAL COSTS
(Consolidated in place including distributed overhead expenditure)

	Fine Crushed Rock		Coarse Crushed Rock		Gravel, etc.		Total	
	Quantity	Unit Cost	Quantity	Unit Cost	Quantity	Unit Cost	Quantity	Unit Cost
1966-67	cu. yds.	\$	cu. yds.	\$	cu. yds.	\$	cu. yds.	\$
Five year average 1962-63 to 1966-67	60,040	6.23	26,224	4.75	939,006	2.00	1,025,270	2.31
	107,804	4.59	42,901	3.48	990,126	2.04	1,140,831	2.33

Direct Labour Road Construction Costs

Costs of 112 roadwork jobs completed in 1966/67 at a cost of \$5.27 million, were analysed in detail.

The analyses, summarized in Tables 1-4, indicate continuing stability in unit costs.

2. TESTING OF MATERIALS AND RESEARCH

Records

The recording system used in the laboratory is being redesigned to make use of the Board's IBM 1620 computer for listing, indexing and analysing test results. A "Dura" automatic typewriter has been installed, and all test report forms have been redesigned with a standardized format suitable for this machine. In conjunction with production of the reports, the machine will produce punched paper tape from which punched cards can be mechanically produced. These can be sorted and used as a basis for material surveys and correlation of test results.

Use of IBM 1620 Computer

Five computer programmes were written in 1966/67 by the staff of the Materials Research Division. These programmes are concerned with statistical computational procedures, which are required in the analysis of test results.

The computer has also been used for calculating and listing the results of strength tests on concrete cylinders. This results in a considerable saving in time.

Metallurgy

The apparatus for the Pellini or nil ductility temperature test on steels, mentioned in the 1965/66 Report, has been put into operation. A successful series of tests has been carried out with the small size of specimen. Work is now proceeding with the larger size of specimen, and also with specimens using pressed notches according to a method devised by the Snowy Mountains Hydro-Electric Authority. This type of notch will have advantages in testing specimens cut from welds, in avoiding heat effects on the weld metal.

Investigations have been carried out on welding procedures, including work with the consumable guide welding process. This process may be useful as a means of splicing plates for compression flanges of steel girders, but further study will be required before it can be sanctioned for use in tension flange splices.

A number of parts of mechanical plant have been examined to determine the causes of failure in service, and a more extensive investigation of metallurgical properties affecting the performance of grader blades and ripper tynes has been initiated. In the case of ripper tynes it has been found that shrinkage cracks at critical points in the cast steel tynes may lead to premature failure, and modifications to the method of casting are envisaged.

Special Cone Penetrometer Tests

One proposal for the foundations of the piers for the Lower Yarra Bridge, was to drive pile groups into a sandy gravel layer whose top surface is at about R.L. minus 90 feet. However, bores showed that the gravel layer, which is generally over 40 feet thick, contains thin lenses or layers of clayey to sandy silt.

The Board carried out investigations to locate and measure the thickness of these relatively softer silt layers or lenses occurring within the gravel layer, at each pier site of the bridge.

Normally, the static penetrometer (also called a "deep sounding cone penetrometer") is used to differentiate rapidly between strata of various strengths. The high penetration resistance developed in the gravel layer made the normal method of use impracticable. Several penetrometer methods were tried until a method was found which overcame all the problems. The method adopted was as follows.

The 6 square inch, 60° cone (Fig. 1) had six water holes and was hardfaced. There were two ribs or low blades on the face of the cone, which displaced the sand particles when rotating through

the sandy gravel layers. Water pumped down the connecting "A" rods kept the cone cool and reduced skin friction on the rods. The rotation was stopped when a soft layer was reached. An approximate measure of the penetration resistance of the softer soil layers was obtained from an oil pressure gauge attached to the hydraulic feed system of the drill head.

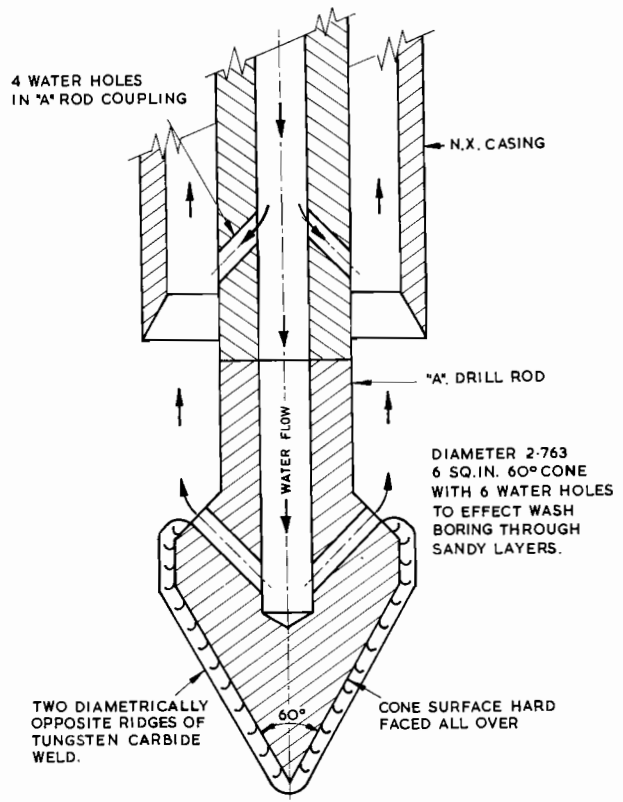

Figure 1—Section of Special Penetrometer Cone for Penetrating Gravel.

3. ROADSIDE DEVELOPMENT

In 1966/67, about 50,000 trees were planted by the Board along its road reserves and extensive preparations were made for 1967/68 planting.

Development of wayside stopping places proceeded during the year, and it was possible to equip about 50 of these with modest facilities for the benefit of the travelling public.

The first toilet block at a Board's roadside rest area was constructed at Garfield on the Princes Highway East. The Tourist Development Authority provided four-fifths of the cost of this work and the Board provided the balance.

4. BITUMINOUS WORK

Extent of Work

The mileages of all types of bituminous surfacing completed during 1965/66 and 1966/67 are compared in Table 5. This shows that 3214 miles were treated in 1966/67 against 3067 miles in 1965/66, an increase of about 5 per cent.

The length of sealed pavement on the Board's declared road system was increased by 140.7 miles in 1966/67, and the length on unclassified roads was increased by over 695 miles, as shown in Table 6. Reconstruction of existing sealed pavements and restoration of the seal coat was carried out on 417.5 miles of the declared system, 3.3 per cent of the sealed sections, compared with 3.0 per cent in 1965/66. Retreatments were carried out on 1164 miles, or 9.3 per cent of the sealed sections, compared with 8.3 per cent in 1965/66.

TABLE 5—BITUMINOUS SURFACING WORK COMPLETED

Type of Road and Plant Used	1965-66	1966-67
	Miles	Miles
Work on roads to which the Board contributed funds:		
(a) C.R.B. declared roads:		
(i) Board's plant	1788	1911
(ii) Municipal plant	63	49
(iii) Contractors' plant	45	84
	1896	2044
(b) Undeclared roads		
(i) Board's plant	940	975
(ii) Municipal plant	67	50
(iii) Contractors' plant	24	25
	1031	1050
Sub-Totals	2927	3094
Work done by other Authorities by Board's plant. (No Board contributions to funds for these works.)		
(i) Municipalities	134	114
(ii) State Instrumentalities	6	6
(iii) Commonwealth Works	—	—
	140	120
Totals	3067	3214

TABLE 6—BITUMINOUS WORK ON VARIOUS ROAD CATEGORIES 1966/67

	State Highways	By-pass Roads	Tourists' & Forest Roads	Main Roads	Total—Board's Declared System	Unclassified Roads	Totals
	Miles	Miles	Miles	Miles	Miles	Miles	Miles
Initial Treatments:—							
Extensions to sealed system—							
(a) Sprayed work	12.8	5.1	15.9	106.9	140.7	691.8	832.5
(b) Plant mix work	—	—	—	—	—	3.5	3.5
Reconstruction of lengths of previously sealed pavements—							
(a) Sprayed work	158.3	0.3	17.3	221.7	397.6	78.9	476.5
(b) Plant mix work	6.8	—	—	13.1	19.9	8.2	28.1
Widening of existing sealed pavements—							
(a) Sprayed work	70.9	1.3	6.5	203.7	282.4	20.7	303.1
(b) Plant mix work	0.5	—	—	2.0	2.5	2.2	4.7
Duplication of existing sealed pavements—							
(a) Sprayed work	27.2	—	—	0.9	28.1	0.3	28.4
(b) Plant mix work	6.8	—	—	1.5	8.3	1.0	9.3
Retreatments:—							
(a) Sprayed reseals	520.1	10.4	43.4	552.8	1126.7	233.2	1359.9
(b) Plant mix work	20.8	1.8	1.3	13.9	37.8	10.4	48.2
Totals	824.2	18.9	84.4	1116.5	2044.0	1050.2	3094.2

Table 6 summarizes the lengths of different categories of bituminous work to which the Board contributed funds during 1966/67

Types of Work

Sprayed initial treatments and retreatments were again the main features, amounting to 97 per cent of the total.

A length of 94 miles of plant mix work was completed during the year, i.e. 3 per cent of the bituminous surfacing programme, compared with 83 miles and 2.9 per cent in 1965/66 (for further details see Table 6). For the plant mix work completed during the year, some 159,000 tons of

bituminous concrete was supplied and spread by contractors operating fixed plants near Melbourne and Geelong.

Costs of Work

The average unit costs of sprayed work completed by the Board's 24 bituminous surfacing units during the year are shown in Table 7. The average costs of sprayed work were approximately the same as those for 1965/66.

**TABLE 7—AVERAGE COST OF SPRAYED BITUMINOUS SURFACING DONE BY
C.R.B. PLANT**
(On roads to which the Board contributed funds during 1966/67)
(Cost in cents per square yard)

Item	Nature of Work																			
	I.T.P. & S. ¾-in. & Over		I.T.P. & S. ½-in.		I.T.P. & S. ⅓-in.		I.T.P. & S. ¼-in. & Sand		Primerseals		I.T. Two- Application Seal only		I.T.S.O. and Reseals ¾-in. & Over		I.T.S.O. and Reseals ½-in.		I.T.S.O. and Reseals ⅓-in.		I.T.S.O. and Reseals ¼-in. & Sand	
Square yards Costed	758,500		3,549,356		2,026,037		957,961		734,080		37,591		844,238		5,294,193		7,199,323		7,107,262	
	cents	%	cents	%	cents	%	cents	%	cents	%	cents	%	cents	%	cents	%	cents	%	cents	%
Material ..	17.0	49.0	17.3	55.1	16.4	61.0	13.9	57.0	9.6	41.9	37.2	49.5	14.6	54.6	13.2	58.2	11.0	58.8	9.3	63.7
Stores ..	1.0	2.9	0.8	2.5	0.7	2.6	0.7	2.9	1.1	4.8	1.3	1.7	0.5	1.8	0.5	2.2	0.4	2.1	0.3	2.1
Plant hire	7.1	20.5	5.9	18.8	4.4	16.4	4.5	18.4	5.3	23.2	15.6	20.8	4.8	17.9	3.8	16.7	3.1	16.6	2.2	15.0
Labour ...	9.6	27.6	7.4	23.6	5.4	20.0	5.3	21.7	6.9	30.1	21.0	28.0	6.9	25.7	5.2	22.9	4.2	22.5	2.8	19.2
TOTALS	34.7	100.0	31.4	100.0	26.9	100.0	24.4	100.0	22.9	100.0	75.1	100.0	26.8	100.0	22.7	100.0	18.7	100.0	14.6	100.0

I.T.P.S. indicates "initial treatment prime and seal".
I.T.S.O. indicates "initial treatment seal only".
* Special experimental job.

**TABLE 8—AVERAGE PRICE OF AGGREGATE
FOR BITUMINOUS SURFACING**
(in roadside stacks)

Material	Prices per cubic yard				1966-67
	1962-63	1963-64	1964-65	1965-66	
	\$	\$	\$	\$	\$
Screenings ..	4.49	4.81	4.92	5.04	5.04
Gravel ..	4.26	3.95	4.12	4.20	4.40
Sand ..	2.16	2.31	2.48	2.50	2.93
Scoria ..	3.27	2.98	2.90	2.78	2.90
Average price all aggregates ..	4.28	4.48	4.58	4.70	4.76

Table 8 sets out the average costs of aggregate over the past 5 years and shows that the 1966/67 average rose 1.3 per cent above the 1965/66 average.

Mention has been made in previous Reports of the use of petroleum tars for precoating limestone aggregates used for single application sprayed work in north-western Victoria. The use of a very light grade of this tar has proved advantageous in reducing the amount of stripping and breakdown of the aggregate.

Field experiments were conducted in 1966/67 to determine the optimum rate of application of binder for a single application seal using limestone aggregate. The experiments covered a large range of rates of application (rates of application were expressed as the percentage of voids of the compacted mass that were filled with binder). Micaceous schist aggregate brought from another area was used on two sections for control purposes. The experimental sections will be kept under observation to obtain design criteria for use in the future.

(b) Bitumen

A third refinery from which the Board commenced to draw stocks, began operations in Victoria during 1966/67. The Board purchased directly some 32,400 tons of bitumen, which was distributed by road and rail by four marketing companies.

The installation of two 8,000 gallon electrically heated bitumen tanks similar to those at Horsham, was commenced at Hamilton. These tanks will be available at the start of the 1967/68 season to assist in distributing all the bulk bitumen used in that area.

Statistics

The Board's IBM 1620 computer has proved of great benefit in the production of

- (a) details of costs and quantities of various types of work and materials
- (b) annual bituminous surfacing statistics.

A more detailed dissection of statistics is possible, with reduced demands on staff. The Board's bituminous surfacing cost sheet was rearranged slightly to comply with key punching requirements, without affecting the method of usage by the field staff.

Materials

(a) Aggregate

A total quantity of approximately 313,000 cubic yards of covering aggregate was used in the sprayed work done by the Board's plant.

(c) Priming Materials

A special light bituminous primer was developed in 1966/67 for priming damp pavements during cold weather. Sections of pavement have been primed with this material under the appropriate climatic conditions. The sections will be observed to compare this primer with other types.

(d) Primerbinders

The 1965/66 Report referred to the use of a particular grade of petroleum tar as a primerbinder for primersealing in winter. This tar was produced in New South Wales. Two special bituminous primerbinders have been developed in Victoria. It is proposed to primerseal several experimental sections to evaluate all of the available types of this material.

As an example of the use of a petroleum tar primerbinder under conditions where a normal sprayed seal may have failed, the following is instanced. A slick bituminous surface, subject to frost and ice, was primersealed under adverse winter conditions to provide a temporary seal. A $\frac{3}{8}$ inch one-sized basalt aggregate was applied to provide a skid resistant surface. The treatment has been found successful, and the section will be retreated during next summer.

Bitumen Sprayers

The Asphalt Division has continued to give consideration to future requirements for bitumen sprayers.

Hydraulic transmission of power from the prime mover to the bitumen pump has been investigated. This will eliminate the use of a separate power unit, and provide a means of interlocking the rate of discharge of bituminous material through the spray bar, with the forward speed of the sprayer. A bitumen sprayer has accordingly been modified by the Mechanical Sub-branch and will undergo calibration tests at the test sprayer pit at the Board's depot, South Melbourne. The Asphalt Division will subsequently carry out precise field tests with this modified equipment.

Sprayer Testing Pit

Construction of a new sprayer testing pit was commenced during 1966/67. It should be completed and available for the testing and calibration of bitumen sprayers in 1967/68. The pit will provide further means for engineers of the Asphalt Division to investigate various problems associated with the spraying of bituminous materials.

BRIDGE SUB-BRANCH

1. DESIGN

Use of Digital Computers

The Board's IBM 1620 computer was used to a greater extent in bridge design than in any other aspect of the Board's work. In processing design problems, 389 hours of computer time were used during 1966/67, a slight increase from 1965/66. The computer was used in the design of 51 bridges, and now plays a significant role in the design process. The following extract of the usage of individual computer programmes illustrates the variety of work processed:

Bridge Geometry Programme	8 bridges
Cross-section Properties	6 bridges
Moments in Continuous Beams	9 bridges
Two Column Pier Analysis	18 bridges
Analysis of Concrete Columns	32 bridges
Foundation Design (Pile Loadings)	8 bridges

For structures included in the Strathmore Bypass Road project, a total of seven individual computer programmes were used for superstructure and sub-structure design. Savings of several man-months of design time were effected: the computer programmes generated rapid and reliable results.

The computer contribution to the substructure design for the Dynon Road, North Melbourne project was also significant. Six sets of computer programmes were utilized for pier and foundation analysis.

Development of New Computer Programmes

Programming work occupied 166 hours in 1966/67, a decrease of 12% from 1965/66. The reduction was due to the needs to train new staff for this work, and to convert existing programmes to utilize the new on-line printer.

The major project undertaken was the programming of a comprehensive system for the analysis of bridge substructures. Much of the work has yet to be completed, although a pilot version of the system was made operational. It is envisaged that the complete system will handle one-, two-, three- and multi-column piers and abutments supporting either simple-span or continuous superstructures.

Other library programmes developed during the year included a simpler method of evaluating longitudinal forces in multi-span bridges with elastic bearings, and a programme to determine the unbalanced shear forces acting on the pile caps of two-column bridge piers.

A three-programme system to facilitate the preparation of specifications for bridgeworks was also developed and tested. The system is based on techniques previously developed for the Board's architectural specifications. All standard specifica-

tions, including alternative clauses, are stored in punched card form. The specification writer can note the portions of standard text required, and supply handwritten details of special text to be inserted. The specification mastercopy for each new project is then printed at 150 lines per minute by the Board's computer.

2. CONSTRUCTION

Dynon Road, North Melbourne

A new bridge on an improved alignment is being constructed at Dynon Road, North Melbourne, over the railway yards. The bridge will provide 2-26 feet traffic lanes separated by a raised median 4 feet wide, and one footpath 6 feet wide.

The Board is responsible for construction of the earthen embankment approaches to the bridge. Special measures, as described below, are being used to accelerate the settlement of compressible soils beneath the road embankment on the Footscray approach.

The embankment is built on a layer of soft estuarine silty clay which varies in depth from 40 to 50 feet. This material has a low shear strength varying between 3 p.s.i. and 5 p.s.i. Preliminary studies showed that the maximum height of bank that could be constructed with an acceptable factor of safety of 1.2 was approximately 12 feet. Accordingly, the extent to which surcharge loading could be applied was strictly limited by embankment stability considerations. A suitable arrangement of sand drains was therefore designed, to produce, in conjunction with the limited surcharge loading, the desired rate of consolidation.

Laboratory tests showed that the silty clays encountered would react unfavourably to disturbance and remoulding. (The permeability of remoulded samples was of the order of 10% of the values obtained from tests on undisturbed samples, and the sensitivity of the material was found to vary from 2 to 5.) Particular care was therefore taken to disturb the soil as little as possible during installation of the drains. This was achieved by driving an open-ended, 16 inch outside diameter steel tube into the ground in stages not exceeding 10 feet, and excavating the core of material from within the tube by percussion methods as driving proceeded. The height of the soil core above the toe of the tube was controlled within strict limits to ensure that "plugging" of the tube did not occur at any time.

The tube was driven in this way to within 5 feet of the bottom of the silty clay layer. It was then cleaned out and backfilled with fine permeable sand, which was saturated before placing. The tube was extracted in stages, during the backfilling process, to avoid arching of the sand.

Drains were generally located at 12 feet centres but this spacing was increased under the lower sections of embankment where higher surcharge loadings could be applied.

The total length of drains installed was approximately 3,600 lineal feet. The average rate of installation was about 150 lineal feet per day.

Piezometers were installed beneath the embankment at about the middle of the silty clay layer. These were ranged in lines both along and at right angles to the road centre line, and were connected to pore pressure measuring devices comprising a combination of stand pipes and Bourdon gauges. A comprehensive system of settlement platforms was also installed over the filled area. Levels are being taken on these at regular intervals to maintain a check on the progress of consolidation and to permit the relationship between settlement and pore pressure dissipation to be established.

In the design it was necessary to substitute structure for embankment on part of the Footscray approach due to the stability limitation on embankment height. These approach spans will consist of 8-63 feet composite steel girder and concrete deck spans. By comparison, on the northern approach, there will be only two spans, of similar construction, one 73 feet long and one 35 feet long.

Barwon River Bridge—Geelong

The 1965/66 Annual Report referred to the proposed widening of the bridge over the Barwon River in Moorabool Street, Geelong. The design provided for minor modification of the existing substructure by the use of post-tensioned concrete crossheads cantilevered from the pier shafts to carry an additional row of welded steel plate girders, on each side of the bridge. The existing piers are founded on timber piles, some of which were driven for the original bridge in 1857. Some details of the construction follow.

The pier crossheads were extended by casting a beam around the top of each existing pier crosshead. The beam is supported on a bearing located at each end of each pier, and is cantilevered 6 feet beyond the outer bearing. The crosshead extension beams are each prestressed with four BBR CS 150 post-tensioned tendons.

The girders on the existing bridge are 8 feet high riveted plate girders, 104 feet long. The widening incorporates an extra line of girders located 8 feet beyond the existing outer girder on each side of the bridge. The new girders are welded mild steel plate units, each 8 feet high and of slender section to minimize weight.

The widening construction work carried out under traffic was completed in a period of 12 months.

Maribyrnong River Bridge—Raleigh's Road

A seven span bridge 478 feet long is being constructed at this site to replace road and tramway bridges which were in poor structural condition. The new bridge carries a roadway 50 feet between kerbs with two 7 feet footways.

The 1964/65 and 1965/66 Annual Reports described the methods adopted to accelerate the consolidation of the compressible strata at the Sunshine abutment. This report refers to the construction procedures used, in view of tram traffic requirements and the confined space for pile driving.

The new bridge is on the same alignment as the original timber and steel girder tramway bridge. Stage construction methods have been used as described below, to maintain the two-way tram service while this bridge is under construction. Road traffic has continued to use the existing road bridge.

Stage 1—

Step 1. The tram traffic was restricted to the existing upstream track while the pier pile groups at the downstream side of the new bridge were driven.

Step 2. The tram traffic was restricted to the existing downstream track while the pier pile groups on the upstream side of the new bridge were driven. The downstream pile caps and columns were constructed during this stage.

Step 3. The tram traffic was restricted to the existing upstream track, and the downstream track and the downstream section of the superstructure were demolished. The abutment piles were driven and then the pier and abutment crossheads and the superstructure for the downstream side of the new bridge were constructed.



Plate 1—Maribyrnong River Bridge. Raleigh's Road. General view showing limited working space available for pile driving frame.

Step 4. The tram traffic was restricted to a temporary single track located on the Stage 1 deck of the new bridge.

Stage 2—

Step 1. The upstream superstructure was demolished and the abutment piles beneath the upstream track were driven and the upstream crossheads and superstructure completed.

Step 2. The tram tracks were located at the final position on the structure.

Step 3. Tram traffic was permitted on the final location—two way, double track.

The two stages of the superstructure are separated by a longitudinal joint running the full length of the bridge.

The bridge foundations consist of concrete-filled 18 inches diameter steel shell piles up to 70 feet long in the abutments and up to 60 feet long in the piers. At some of the pile groups it was necessary to use a special pile toe incorporating an RSJ to penetrate hard layers above the contract level and to achieve the required degree of fixity. The pile driving was done with a B.S.P. diesel hammer on hanging leaders supported from Dutch shear legs. This type of pile driving frame was very suitable for this site where working space was extremely confined (plates 1 and 2).

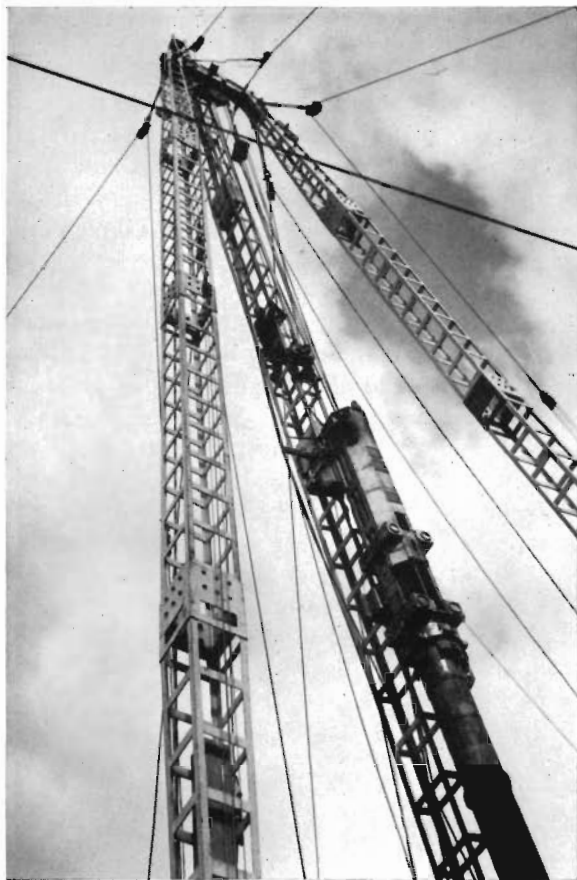

Plate 2—Maribyrnong River Bridge, Raleigh's Road. Pile driving in progress.

Mickleham Road Overpass

Two continuous four span bridges on the Tullamarine By-pass Road over Mickleham Road were recently completed. Each consists of two 43 feet approach spans and two 85 feet main spans, built on a skew of approximately 45°, with a width of 28 feet between kerbs. A general description of the construction methods for the superstructure follows.

The superstructures consist of precast pre-tensioned beams acting compositely with the deck slab. Continuity is achieved by the provision of concrete infill between the ends of adjacent beams, and by incorporating longitudinal reinforcement in the deck slab over each pier.

After placing the beams, all decks were cast with the exception of the lengths over piers containing the deck continuity reinforcement. The remaining sections of the deck slabs, together with the pier diaphragm beams and the infill between beam ends, were cast as one unit at a later stage.

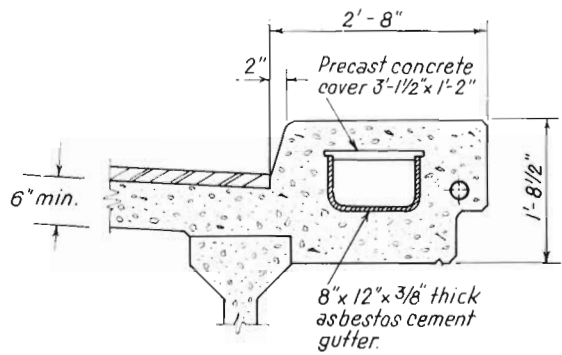

TYPICAL CROSS SECTION OF DRAINAGE KERB.

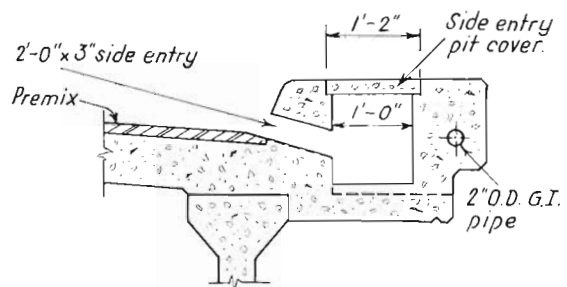

SECTION OF DRAINAGE ENTRY.

Scale: 3/4" = 1'-0"

Figure 2—Mickleham Road Overpass—Provision for Deck Drainage.

At the time of construction, the 85 feet main span beams each weighing 19.6 tons were the longest pre-tensioned units which had been used by the Board. To enable the beams to function as members of a continuous system, bond prevention was employed on certain bottom tendons at the beam ends and a large number of deflected strand tendons were used. Subsequently these beams have been exceeded in length and size by the pre-tensioned units required for the Phillip Island Bridge.

The provision for deck drainage on these bridges is shown in Fig. 2. Runoff is collected through a series of side entry openings in a deepened kerb section containing a 12 inches x 8 inches channel. The drainage is discharged from each end of the bridge through downpipes set in the abutment crosshead.

Phillip Island Bridge

The Phillip Island Bridge, now being constructed over the eastern entrance to Westernport Bay, will replace the suspension bridge which links Phillip Island to the mainland at San Remo. The bridge is being constructed under contract by John Holland & Co. Pty. Ltd. The contract completion date is December, 1968. When completed, the new bridge will be approximately 2,100 feet long, consisting of sixteen 100 feet outer spans with a continuous 150 feet-200 feet-150 feet span arrangement at mid-channel, as set out in Fig. 3.

The 1962/63 and 1964/65 Annual Reports referred to foundation investigations for this bridge. These notes concern the designs subsequently adopted for the piers, and refer to the prestressed beams for the structure.

In general the foundation material consists of layers of decomposed basalt varying in thickness and degree of decomposition. In many places thick tuff seams are included. The firmer decomposed layers are not necessarily at the lower depths. Quite commonly they are found overlaying a softer decomposed material.

Piers 1 to 5 have spread footings varying in size from 13 feet x 10 feet to 13 feet x 13 feet which are founded in the upper layers of medium to firm decomposed basalt. The footings of piers 1 to 4 are at approximately R.L. minus 10 feet while those of pier 5 are approximately 5 feet deeper. The design bearing pressure in each case is 5 tons per square foot.

Piers 6, and 12 to 18, and both abutments, have piled foundations. The piles are 18 inches internal diameter steel shells and vary in length from approximately 15 feet (San Remo abutment) to 68 feet (design length at pier 15).

Piers 7 to 11 were designed as 9 feet diameter cylinders, belled out at the base to give a maximum bearing pressure of 20 tons per square foot. Before construction commenced, detailed bore information at these main channel piers was limited, due to the high velocity tides and lack of substantial staging from which to drill. Subsequent drilling

at pier 8 indicated that solid rock was considerably deeper (R.L. minus 73 feet approximately) than was estimated from seismic tests (R.L. minus 38 feet).

When the excavation at pier 8 reached the design foundation level (R.L. minus 38 feet), plate bearing tests were carried out and the firm decomposed basalt at this depth was found to have an ultimate bearing capacity of 30 tons per square foot. This pier was then redesigned, the original bell shaped footings being changed to cross type spread footings giving a maximum bearing pressure of 10 tons per square foot.

Construction of piers 7, and 9 to 11 has not yet commenced. Some alteration to these footings may also be required when detailed bore information is available.

Eighty prestressed beams each 100 feet long are being manufactured for the sixteen outer spans. They are 4 feet 6 inches deep and Tee shaped, and weigh 43.5 tons each. The top flange is 3 feet wide, and will form part of the deck of the completed structure. Five beams will be used in each span, spaced at 7 feet 3 inches centres.

The beams are cast in steel forms fabricated in three basic lengths, with separate sections for the intermediate and end diaphragms. The soffit form of the beams is laid with a 1 inch downward camber. This initial reverse camber is necessary, to limit the upward camber after release to $\frac{3}{8}$ inch, the calculated deflection of the beams due to the application of the remaining dead load.

The prestress force is obtained with the use of twenty five 0.6 inch diameter 7 wire strand. To permit the beams to act as members of a continuous system, all but six tendons are deflected in each beam. Four hold down points are provided for this purpose. Each strand is stressed separately to an initial load of 38,960 pounds, the load being read directly from the jack dynamometer as well as being determined from elongation measurements.

After erection, each set of four spans of beams is to be made continuous for live load, by casting integrally the end diaphragm between adjacent spans and the in situ deck slab containing longitudinal continuity reinforcement. To assist in development of continuity, eight 1½ inch high strength bars are provided at the end of each beam.

Required minimum concrete cylinder strengths are 4,300 p.s.i. at release of prestress and 5,500 p.s.i. at 28 days.

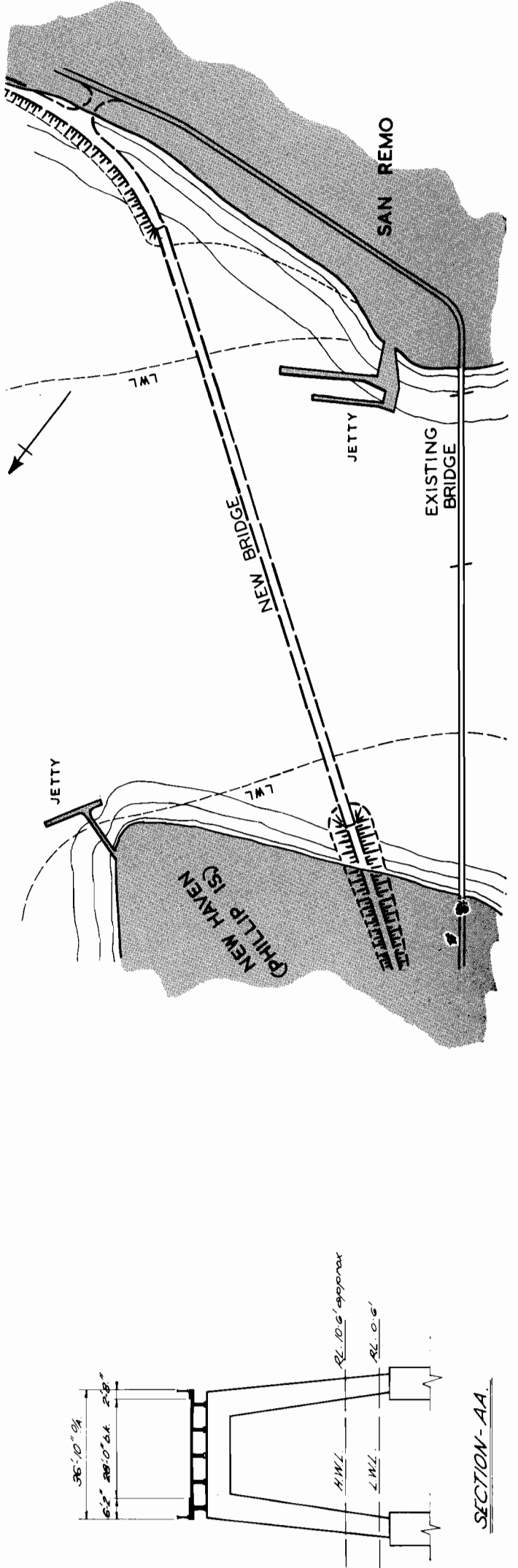
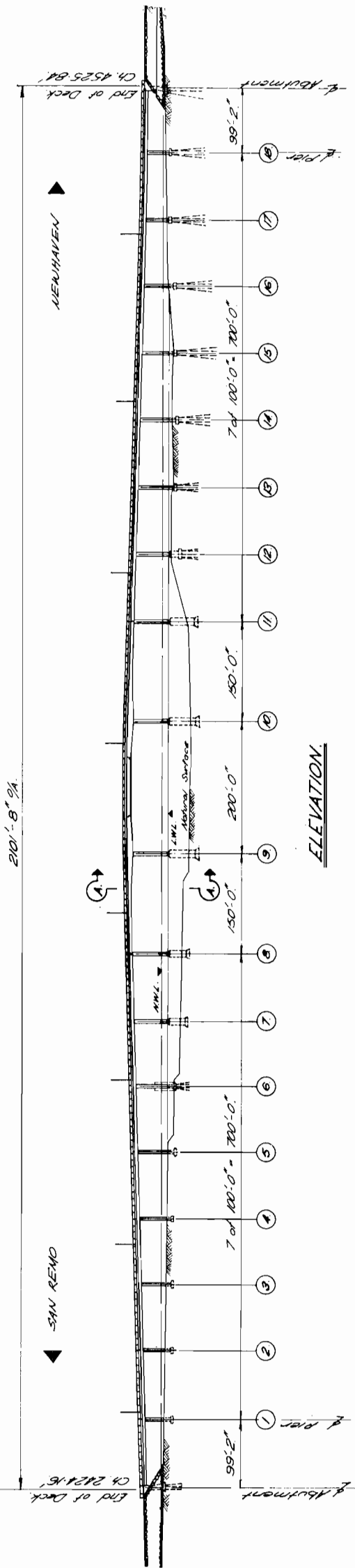

Figure 3—Phillip Island Bridge—General Layout.

ROAD DESIGN SUB-BRANCH

1. TRAFFIC ENGINEERING AND BY-PASS ROAD INVESTIGATIONS

Traffic Studies

The annual traffic census was conducted on 15th March 1967. Twelve hour classification counts were taken manually at a total of 1633 stations, 671 of which were on State highways, 794 on other Board's declared roads and 168 on unclassified roads.

The Highway Traffic Index (100 in the base year 1933) rose from 881 in 1966 to 919 in 1967, an increase of 4.3%. The rate of increase has now been reasonably steady for two years and parallels the 1959 prediction (Technical Bulletin No. 17).

The programme of automatic large sample hourly counts on rural State highways was continued. Detailed information at 25 stations will be published with the 1967 Annual Traffic Census.

In February the Board began the employment of a three man traffic survey team, equipped with a station wagon fitted with a ball-bank indicator and an accurate odometer. The team has assisted in major traffic surveys, and studies concerning traffic operations.

Major traffic studies conducted included week-day origin and destination surveys at Echuca, Inverloch and Bacchus Marsh. The last named survey was repeated on a Sunday to obtain information on weekend traffic. The technique used was that of recording numberplates at all points of entry and exit of the area under study. The use of portable tape recorders facilitated the field recording of results. The IBM 1620 computer was used to match the numbers recorded at the various survey points.

Mr. Boris B. Petroff visited Melbourne in May, at the Board's invitation. Mr. Petroff was until his recent retirement the United States Bureau of Public Roads' expert on traffic counting, and an acknowledged authority on the subject. He spent two days in conference with Board's engineers, and described the technique he has evolved for counting traffic volumes. His methods are being examined with a view to their application in Victoria for obtaining annual average daily traffic data with a coverage similar to that of the March annual traffic census, but more accurately and economically by use of automatic traffic counters rather than manually.

Road Signs

The Board continued to collaborate technically and financially with the Traffic Commission in setting up the Metropolitan Route Numbering System, as mentioned in previous Annual Reports. Practically all metropolitan councils have erected route markers and the system is proving of considerable value to travellers in Melbourne.

The Board's standards for plywood advance direction signs were amended in 1966/67 to provide for an increase in legend size from 5 inches to 6 inches, and a larger panel size to accommodate this increase. The signs are being supplied on melamine (high density) overlaid, exterior grade plywood, generally $\frac{3}{8}$ inch thick. A reduction of about 25% in manufacturing cost has resulted from the use of this material, compared with conventional materials such as steel or aluminium. The appearance is improved due to the absence of seams and other surface irregularities. It is expected that the signs will have a life expectancy of 8-10 years, matching the life of the reflective materials used.

Linemarking

The Board maintained centre and lane line markings on a total of 5707 route miles of road during 1966/67, comprising 3735 miles (of which 1595 miles are reflectorized) on State highways, 1678 miles on other Board's declared roads, and 294 miles on unclassified roads, the last at the request and cost of municipalities.

The total length of equivalent standard stripe (i.e. 10 feet x 3 inch line, 30 feet gap) painted was 15,036 miles. This is an increase of 14% over the 1965/66 length. An increase of this order may be expected annually over the next few years, as more duplicated carriageways come into operation and more rural roads meet the traffic volume warrants for centre line striping.

The Board's small pavement marking unit striped 286 miles of urgently required short sections of centre line stripe on new work when other units were not available. It also painted or repainted 1349 pavement arrows, 34 complete sets of railway crossing markings and several complete intersection markings, and removed 31 miles of standard stripe using chemical paint stripper. With an increasing work loading, it is likely that an additional unit of this type will be required in 1967/68.

Each of the Board's eight country Divisions has now been issued with a "Dyco" model V15 small linemarker. All these Divisions are therefore able to replace short lengths of centre line stripe on reseals and reconstructed pavement when the main units are not available, and to paint and maintain a variety of other pavement markings.

The total cost of linemarking carried out by the Board in 1966/67 was \$228,885, including work to the value of \$18,981 by Divisions. The average cost per mile of equivalent standard stripe painted by the main units was \$12.28, compared with \$13.05 in 1965/66.

By-Pass Roads Investigations

Investigation of the locations of by-pass roads is occupying an increasing part of the design activity of this section (Traffic and Location Section). In 1966/67 functional layouts were

completed, or nearly so, for the following major projects:

- (a) a new freeway route through the western suburbs from the Princes Highway West to the proposed Lower Yarra Crossing; and an interchange at Graham Street, Port Melbourne. These works will form the approaches to the crossing. The design, based on present and future requirements, has required the consideration of complex interchanges with present roads, and with possible new routes
- (b) the Healesville Freeway between Orchard Grove, Blackburn and Morack Road, Vermont
- (c) the Mornington Peninsula By-pass Road from the Nepean Highway at Dromana, to Eastbourne Road, Rosebud.

Preliminary layouts or investigations have been made on these projects:

- (a) Bacchus Marsh by-pass. This preliminary layout is practically complete. The proposal is part of Special Project No. 5 on the Western Highway, scheduled to commence at an early date.
- (b) the proposed Morwell by-pass, connecting with a new route to Churchill. A re-examination was made of this proposal. The Housing Commission has utilized a design, prepared by the Board for the Commission, of a freeway route through Churchill, and has constructed the first grade separation on the route, adjacent to the new Town Centre.

2. ENGINEERING PLANS AND SURVEY

Engineering Surveys

Head Office engineering survey parties completed a total of 506 miles of survey during the year, as follows:

State highways	89 miles
By-pass roads	33 miles
Other roads	14 miles
Photo control	370 miles

Divisional staff also completed a considerable mileage of engineering surveys for road and bridge works. No engineering surveys were carried out by consultants.

Plans for Road Construction

Comparative figures regarding final construction plans completed in 1966/67 and 1965/66 are:

	1966/67	1965/66
Linear miles	87	83
Estimated cost of roadworks	\$9,530,000	\$11,300,000
Final plan sheets	1,512	1,611
Separate projects	51	53

A considerable amount of investigation and draft design was carried out in addition to the production of the final plans.

Consultants completed the design of one job to the approximate value of \$400,000 in 1966/67.

Some of the larger jobs for which plans were completed, included the following:

Princes Highway East Section 1	Duplication Waverley Road to Grange Road	(0.6 m)
Princes Highway East Section 1	Duplication Hallam to Narre Warren	(2.6 m)
Princes Highway East Section 1	Reconstruction at Tynong	(2.5 m)
Princes Highway East Section 4	Reconstruction Wombat Creek to Dinner Creek	(2.4 m)
Princes Highway West Section 1	Reconstruction Millers Road to McDonald Road	(0.5 m)
Princes By-pass Road (Laverton)	Point Cook interchange	(1.0 m)
Hume Highway Section 1	Beveridge deviation	(2.1 m)
Hume Highway Section 1	Dysart to Seymour	(3.2 m)
Western Highway Section 1	Duplication west of Pykes Creek	(2.0 m)
Maroondah Highway	Reconstruction Yarck to foot of Merton Gap	(4.5 m)
Maroondah Highway	Cerberus Creek to Taggerty	(4.4 m)
Burwood Highway	Morack Road to east of Stud Road	(2.6 m)
South Gippsland Highway Section 1	Reconstruction Falls Creek to Foster deviation	(2.5 m)
Nepean Highway	Woralla Drive to Tower Road	(1.0 m)
Omeo Highway Section 2	Reconstruction Black Camp Creek to Gibson's deviation	(4.0 m)
Pyrenees Highway Section 1	Underpass at Tuaggra Street, Maryborough	(0.3 m)
Warrigal Road	Grade separation at level crossing, Oakleigh	
Strathmore By-pass Road	Bell Street to Calder Highway including Bell Street and Bulla Road interchanges	(6.0 m)
Taylor Bay Road	Haines Saddle to Maintongoon Road	(5.0 m)

Plans which are well advanced for some of the larger jobs are as follows:

Princes Highway East Section 1	Duplication Grange Road to Poath Road	(1.8 m)
Princes Highway East Section 1	Reconstruction Castlebar Road to Ferntree Gully Road	(1.5 m)
Princes By-pass Road	Kororoit Creek Road interchange	
Hume By-pass Road (Tallarook)	Deviation at Tallarook (being carried out by consultants)	(2.0 m)
Burwood Highway	Duplication from Tyner Road to Ferntree Gully Road	(2.3 m)
Burwood Highway	Duplication from east of Dorset Road to overhead railway bridge in Ferntree Gully	(1.7 m)
Maroondah Highway	Blacksprings Hill duplication	(2.3 m)
Nepean Highway	Reconstruction Moorabbin overpass to Warrigal Road	(4.0 m)
Dynon Road	Hopetoun Bridge approaches	
Dynon Road	Railway overpass	

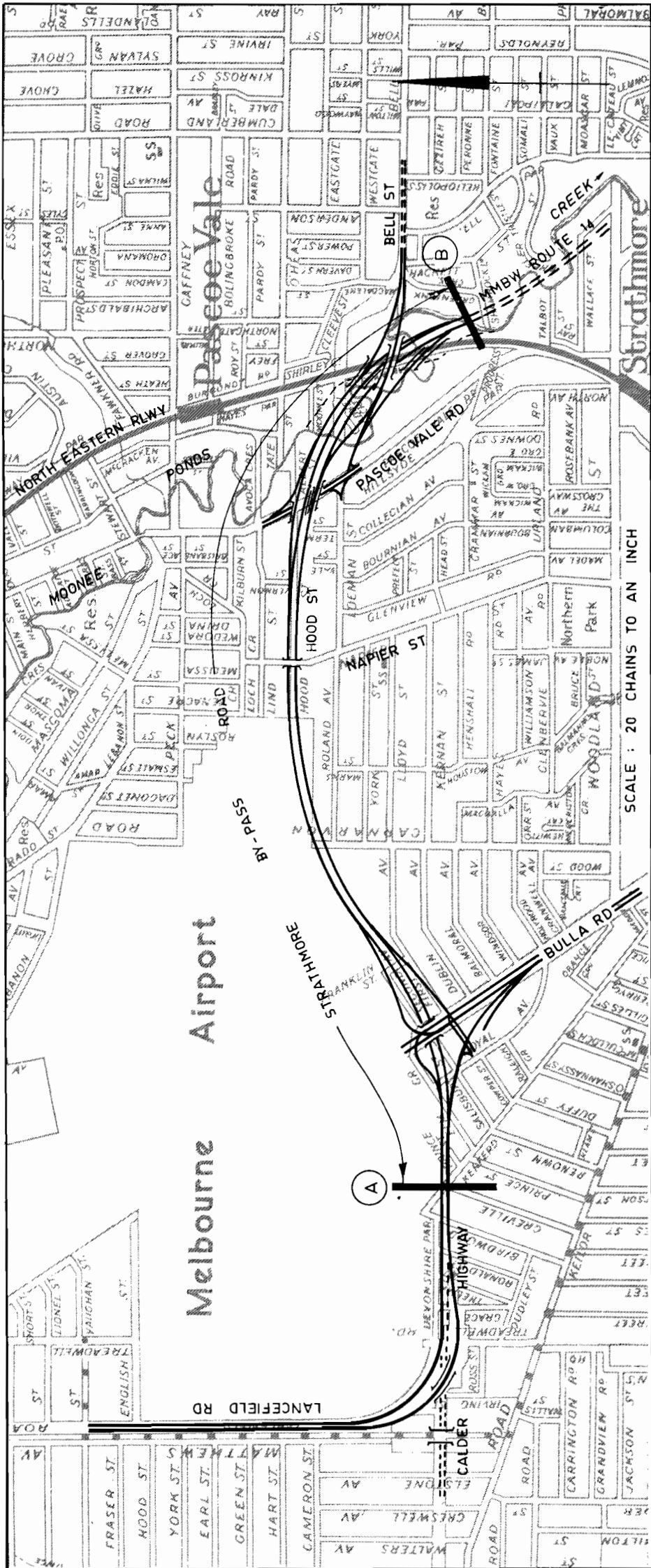

Fig. 4—Strathmore By-pass Road—Locality Plan

Specifications

Comparative figures for supply and construction contracts for this year and last year are:

	1966/67	1965/66
Contracts for which specifications were prepared	136	136
Total value of all contracts (approximately)	\$5,000,000	\$10,000,000
Specifications for construction contracts	18	31
Total value of construction contracts	\$1,800,000	\$8,800,000
Value of special projects advertised	Nil	\$3,500,000

The Section prepared 16, and Divisions prepared 2, of the 18 specifications for construction contracts.

The reduction of \$7,000,000 in the value of construction contracts (including Special Projects) was due to commitments of this order being carried over from 1965/66 to 1966/67. Completed road construction plans to the value of \$7,000,000 were uncommitted at the end of 1966/67 and were therefore available for 1967/68.

By-pass Road Standards

The Board approved standards for by-pass roads in urban and outer urban areas. The approved standards are summarized in Table 9. These standards will be set out in a booklet for the guidance of Board's road designers until the Freeway Design Manual is available.

Strathmore By-pass Road

Construction plans for the Strathmore By-pass Road were produced in 1966/67. Some unusual problems in surveying and design were overcome in the production of these plans.

This by-pass road is part of the Tullamarine freeway which connects the City of Melbourne with the Tullamarine Airport. The road will link the proposed Melbourne and Metropolitan Board of Works' Route 14 section of the freeway along the Moonee Ponds Creek, with the Calder Highway section, south of the Melbourne Airport (Fig. 4).

The by-pass road will consist of about 2 miles of divided highway and about 4 miles of ramps and connecting roads, located in a predominantly residential district some 6 miles from Melbourne. Initially it will be basically a four lane divided road with full access control and grade separated intersections. Provision is made for future de-

velopment to an eight lane divided road. Construction of the first stage will involve about 1,300,000 cubic yards of earthworks, 142,000 square feet of bridging and 117,000 square yards of paving including sealed shoulders.

Features of the by-pass road include an interchange with Bell Street overpassing the north-east railway line and the deviated Moonee Ponds Creek, an overpass of Pascoe Vale Road, an underpass of Napier Street, and a diamond interchange at Bulla Boad (Plate 3). The Bell Street interchange provides direct connections between the freeway, Bell Street and Pascoe Vale Road (Plate 4). A collector-distributor roadway is provided parallel to the main southbound carriageway, between Pascoe Vale Road and the railway. This will enable eastbound traffic from the by-pass road to Bell Street, and southbound traffic from Pascoe Vale Road to the by-pass road, to weave clear of the through carriageways.

Design mapping procedures were adopted in the design, using base maps at a scale of 40 feet to an inch, with a 2 feet contour interval, produced by photogrammetric means. The alignments of the through carriageways, and ramps and connecting roads were computed, and co-ordinated throughout at close intervals. The whole design was carried out by this method without the usual need to peg median and carriageway centre lines.

Reasons for the use of this method included:

- (i) ground survey would have been slow and tedious due to the building and other development along the proposed route
- (ii) median and carriageway centre lines could not be pegged, because of the development. In any case, attempts to use these conventional methods in the more complex areas, such as the Bell Street interchange area, would have led to confusion in identification of centre line, reference, and ramp survey pegs
- (iii) accurate and detailed survey information over a wide area was necessary before the geometry could be fixed, because of the relatively complex geometry and the various controls
- (iv) the considerable savings in survey time and the very complete data obtained by photogrammetric methods, permitted preliminary design to be completed at an early date. Detailed road and bridge design, including foundation investigations could therefore be started much earlier.

The standards listed in Table 9 were generally used on this job.

An extensive system of bench marks and reference marks was established throughout the area to facilitate the setting out of the co-ordinated lines during construction.

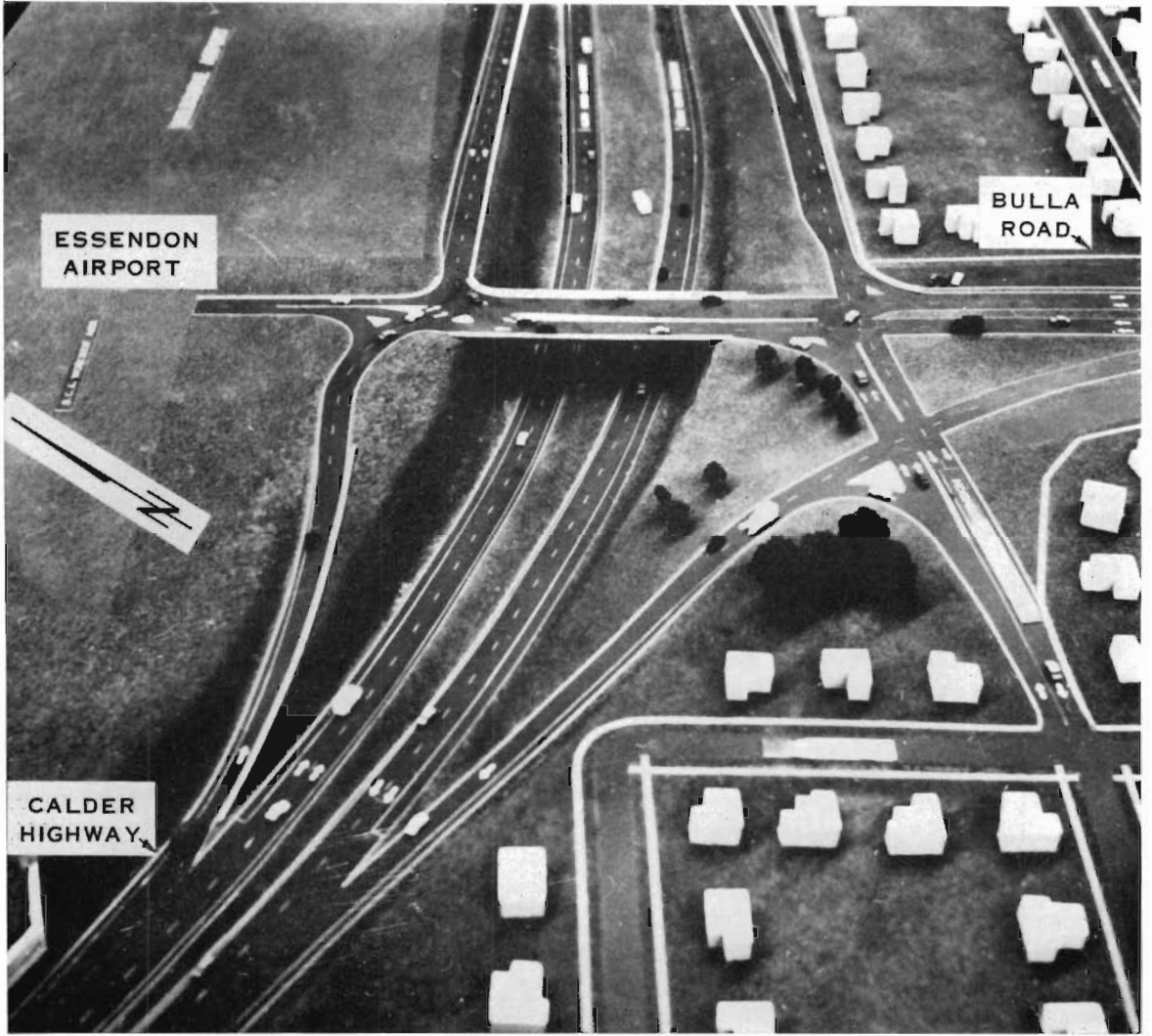

Plate 3—Strathmore By-pass Road Model—Bulla Road Interchange.

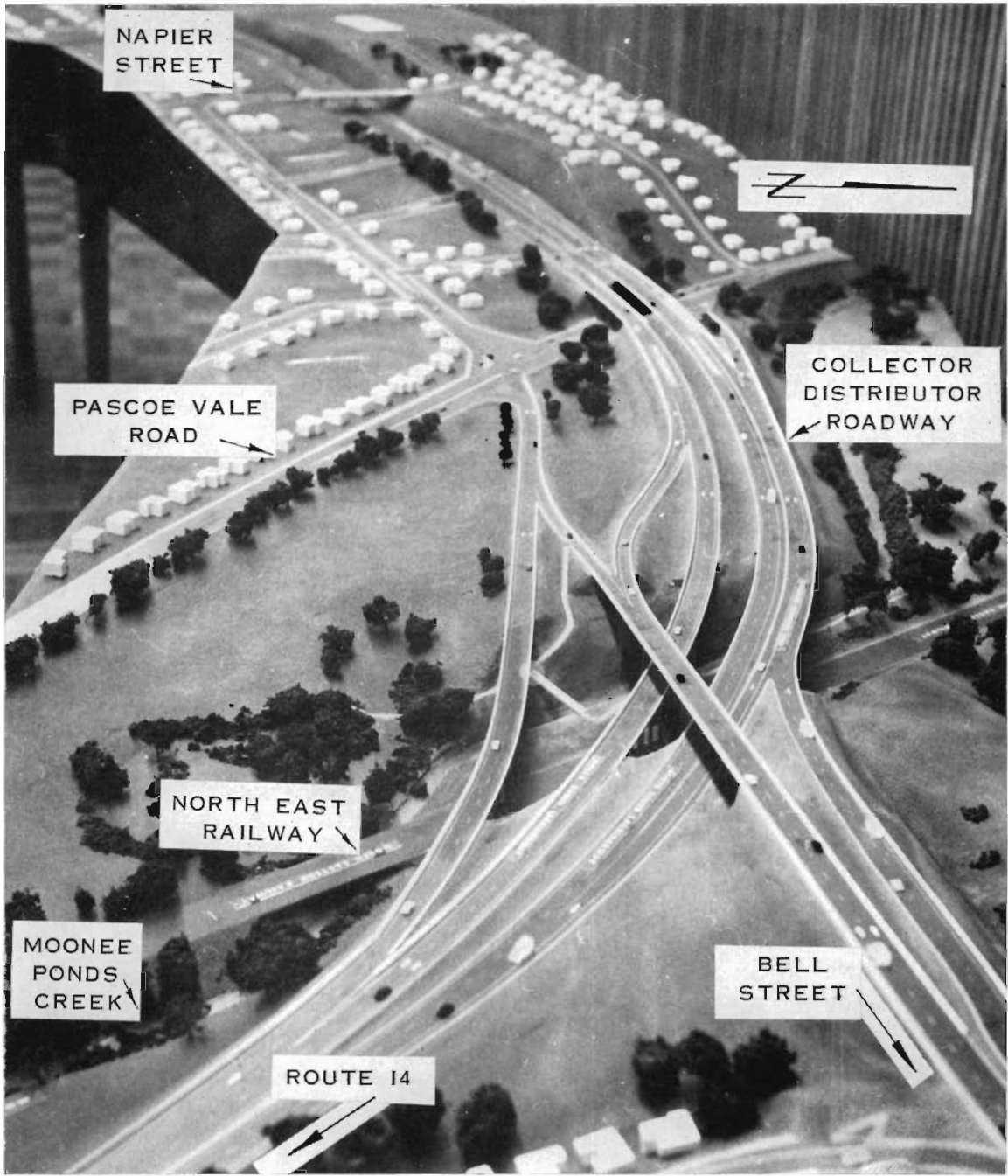

Plate 4—Strathmore By-pass Road Model—Bell Street Interchange.

TABLE 9

SUMMARY OF DESIGN STANDARDS FOR BY-PASS ROADS IN URBAN AND OUTER URBAN AREAS

Meaning of abbreviations used in this table—

V	=	Vehicle speed in miles per hour
E	=	Superelevation in feet per foot
F	=	Coefficient of sideways friction between vehicle tyres and road pavement
R	=	Curve radius in feet
N.A.A.S.R.A.	=	National Association of Australian State Road Authorities
B.S.T.	=	Bituminous surface treatment
H	=	Height or depth of fill or cut from the edge of the formation to the natural surface.

1. HORIZONTAL ALIGNMENT

(a) *Through Carriageways*

- | | |
|---|--|
| (i) "V" | 70 m.p.h. |
| (ii) "E" & "F" desirable max.
absolute max. | E = 0·05, F = 0·07
E = 0·06, F = 0·12 |
| (iii) Equivalent "R" (rounded)
desirable min.
absolute min. | 2,800 ft.
1,800 ft. |
| (iv) Type of curve | Transition for R less than 3,000 ft. Can use circular curve for R greater than 3,000 ft. |

(b) *Turning Roadways*

- | | |
|---|--|
| (i) "V" | 50 m.p.h. min. |
| (ii) "E" & "F" desirable max.
absolute max. | E = 0·06, F = 0·10
E = 0·08, F = 0·14 |
| (iii) Equivalent "R" (rounded)
desirable min.
absolute min. | 1,050 ft.
750 ft. |
| (iv) Type of curve | Transition for R less than 1,600 ft. Can use circular curve for R greater than 1,600 ft. |

(c) *Ramps and Loops*

- | | |
|---|--|
| (i) "V" | Ramps—30 m.p.h. min.
Loops—25 m.p.h. min. |
| (ii) "E" & "F" absolute max. | E = 0·08, F = 0·16 |
| (iii) Equivalent "R" (rounded)
absolute min. | Ramps 250 ft.
Loops 180 ft. |
| (iv) Type of curve | Either transition or use 3 centre curve |

2. HORIZONTAL SIGHT DISTANCE

(a) *Through Carriageways*

- | | |
|-------------------------|--|
| (i) Standard | Stopping sight distance |
| (ii) "V" | 70 m.p.h. |
| (iii) Basis of standard | N.A.A.S.R.A.
Reaction time 2·5 sec.
Eye height 3 ft. 9 in. |

(b) *Turning Roadways*

- | | |
|-------------------------|--|
| (i) Standard | Stopping sight distance |
| (ii) "V" | Equivalent to "V" adopted for horizontal alignment. |
| (iii) Basis of standard | N.A.A.S.R.A.
Reaction time 2·5 sec.
Eye height 3 ft. 9 in. |

(c) *Ramps and Loops*

- | | |
|-------------------------|--|
| (i) Standard | Stopping sight distance |
| (ii) "V" | Equivalent to "V" adopted for horizontal alignment. |
| (iii) Basis of standard | N.A.A.S.R.A.
Reaction time 2·5 sec.
Eye height 3 ft. 9 in. |

TABLE 9 *continued*

3. VERTICAL SIGHT DISTANCE

(a) *Through Carriageways*

- (i) Standard Stopping sight distance
- (ii) "V" 70 m.p.h.
- (iii) Basis of standard crests N.A.A.S.R.A.
Reaction time 2.5 sec.
Eye height 3 ft. 9 in.
- (iv) Basis of standard sags N.A.A.S.R.A. headlight
- (v) Minimum length of sags 250 ft. (provided drainage grades can be obtained)

(b) *Turning Roadways*

- (i) Standard Stopping sight distance
- (ii) "V" Equivalent to "V" adopted for horizontal alignment
- (iii) Basis of standard N.A.A.S.R.A.
Reaction time 2.5 sec.
Eye height 3 ft. 9 in.

(c) *Ramps and Loops*

- (i) Standard Stopping sight distance
- (ii) "V" Equivalent to "V" adopted for horizontal alignment
- (iii) Basis of standard crests N.A.A.S.R.A.
Reaction time 2.5 sec.
Eye height 3 ft. 9 in.
- (iv) Basis of standard sags Vertical acceleration 0.05 g.
- (v) Minimum length of sags 100 ft.

4. GRADES

(a) *Through Carriageways*

- (i) Minimum 1 in 300
- (ii) Desirable maximum 3%
- (iii) Absolute maximum 5%

(b) *Turning Roadways*

- (i) Minimum 1 in 300
- (ii) Desirable maximum 3%
- (iii) Absolute maximum 5%

(c) *Ramps and Loops*

- (i) Minimum 1 in 300
- (ii) Desirable maximum 5%
- (iii) Absolute maximum 8%

5. LANE WIDTHS

- (a) *Through Carriageways* 12 ft.
- (b) *Turning Roadways* 12 ft.
- (c) *Ramps and Loops* 12 ft. (When a single lane ramp or loop is over 1,000 ft. long, provide two lanes)

6. SHOULDER WIDTHS

(a) *Through Carriageways*

- (i) Left shoulder 10 ft. B.S.T.
- (ii) Right shoulder 4 ft. B.S.T. (4 lanes)
10 ft. B.S.T. (6 or 8 lanes)

(b) *Turning Roadways*

- (i) Left shoulder 10 ft. B.S.T.
- (ii) Right shoulder 4 ft. B.S.T.

TABLE 9 *continued*

(c) <i>Ramps and Loops</i>	
(i) Left shoulder	8 ft. B.S.T. with one lane 4 ft. B.S.T. or kerb with two lanes
(ii) Right shoulder	4 ft. B.S.T. or kerb with one or two lanes
7. SHOULDER WIDTHS ON STRUCTURES	
(a) <i>Through Carriageways</i>	
(i) Structures up to 100 ft. long	
(1) left shoulder	10 ft. B.S.T.
(2) right shoulder	4 ft. B.S.T. (4 lanes) 10 ft. B.S.T. (6 or 8 lanes)
(ii) Structures over 100 ft. long	
(1) left shoulder	8 ft. B.S.T.
(2) right shoulder	2 ft. B.S.T. (4 lanes) 8 ft. B.S.T. (6 or 8 lanes)
(b) <i>Turning Roadways</i>	
(i) Structures up to 100 ft. long	
(1) left shoulder	10 ft. B.S.T.
(2) right shoulder	4 ft. B.S.T.
(ii) Structures over 100 ft. long	
(1) left shoulder	8 ft. B.S.T.
(2) right shoulder	2 ft. B.S.T.
(c) <i>Ramps and Loops</i>	
(i) Structures up to 100 ft. long	
(1) left shoulder	8 ft. B.S.T. with one lane 4 ft. B.S.T. or kerb with 2 lanes
(2) right shoulder	4 ft. B.S.T. or kerb with one or two lanes
(ii) Structures over 100 ft. long	
(1) left shoulder	8 ft. B.S.T. with one lane 4 ft. B.S.T. or kerb with 2 lanes
(2) right shoulder	2 ft. B.S.T. or kerb with one or two lanes
8. MEDIAN WIDTHS—INCLUDES RIGHT SHOULDERS	
(a) <i>Through Carriageways</i>	
(i) 8 lanes ultimate	26 ft. ultimate (add 4 ft. if there are central piers in the median)
(ii) 6 lanes ultimate	50 ft.
(b) <i>Turning Roadways</i>	
	—
(c) <i>Ramps and Loops</i>	
	—
9. CLIMBING LANES	
(a) <i>Through Carriageways</i>	
(i) Truck performance curves	N.A.A.S.R.A.
(ii) Begin lane	When speed of design truck drops to 25 m.p.h.
(iii) End lane	When speed of design truck reaches 25 m.p.h.
(iv) Entry taper	1 in 20
(v) Exit taper	1 in 50
(vi) Width of lane	12 ft.
(vii) Width of left shoulder	4 ft. B.S.T.

TABLE 9 *continued*

(b) <i>Turning Roadways</i>	
(i) Truck performance curves	N.A.A.S.R.A.
(ii) Begin lane	When speed of design truck drops to 25 m.p.h.
(iii) End lane	When speed of design truck reaches 25 m.p.h.
(iv) Entry taper	1 in 20
(v) Exit taper	1 in 50
(vi) Width of lane	12 ft.
(vii) Width of left shoulder	4 ft. B.S.T.
(c) <i>Ramps and Loops</i>	—
10. CROSS-FALL ON STRAIGHTS	
(i) Traffic lanes	1 in 48
(ii) Shoulders	1 in 24 if sealed 1 in 40 if bituminous concrete 1 in 48 on structures
11. WIDENING FOR GUIDE POSTS, GUARD RAIL, ETC.	5 ft. throughout to provide for guard fence, guide posts, signs, lighting, etc.
12. CUT AND FILL SLOPES	
(i) For "H" up to 6 ft.	H = 0 ft. to 3 ft., use $\frac{12}{H}$ to 1 H = over 3 ft., use 4 to 1
(ii) For "H" over 6 ft.	H = 0 ft. to 6 ft., use $\frac{12}{H}$ to 1 H = over 6 ft., use 2 to 1
13. ROUNDING CUTS AND FILLS	Tops and toes of cuts and fills to be smoothed out.
14. VERTICAL CLEARANCE AT STRUCTURES	17 ft. 6 in. over through carriageways
15. HORIZONTAL CLEARANCE AT STRUCTURES	3 ft. from edge of shoulder, or 13 ft. from edge of pavement
16. GUARD RAIL WARRANTS	
(i) Height of fill	Greater than 10 ft.
(ii) Fill slope	Steeper than 4 to 1
(iii) Curves	Less than 70 m.p.h., when fill greater than 6 ft.
(iv) Grades	On down grades greater than 5%, combined with curvature, regardless of height of fill
17. DRAINAGE DESIGN FREQUENCY	Major cross drainage—50 year frequency Longitudinal drainage—10 year frequency

PT	CHAINAGE	FINISHED SURFACE R.L	OFFSET FROM C.L	C.L		SECTION EARTHWORKS		TOTAL EARTHWORKS	
				CUT	OR FILL	CUT	FILL	CUT	FILL

BATTER PT		2046.90	17.98L						
1		2038.56	11.00L						
2		2038.59	10.00L						
3	59872.25	2038.81	0.00 CL	6.75C	352	0	64844	52092	
4		2038.59	10.00R						
5		2038.56	11.00R						
BATTER PT		2044.58	16.83R						
59872.25									
BATTER PT		2046.00	18.63L						
1		2036.36	11.00L						
2		2036.39	10.00L						
3	59900.00	2036.62	0.00 CL	8.07C	253	0	65097	52092	
4		2036.39	10.00R						
5		2036.36	11.00R						
BATTER PT		2044.06	17.66R						
59900.00									
BATTER PT		2028.45	14.05L						
1		2027.99	11.00L						
2		2028.02	10.00L						
3	60000.00	2028.25	0.00 CL	1.19C	559	0	65656	52092	
4		2028.02	10.00R						
5		2027.99	11.00R						
BATTER PT		2028.81	14.23R						
60000.00									
BATTER PT		2009.88	26.49L						
1		2020.21	11.00L						
2		2020.24	10.00L						
3	60100.00	2020.47	0.00 CL	6.16F	7	328	65663	52420	
4		2020.24	10.00R						
5		2020.21	11.00R						
BATTER PT		2015.43	18.17R						
60100.00									

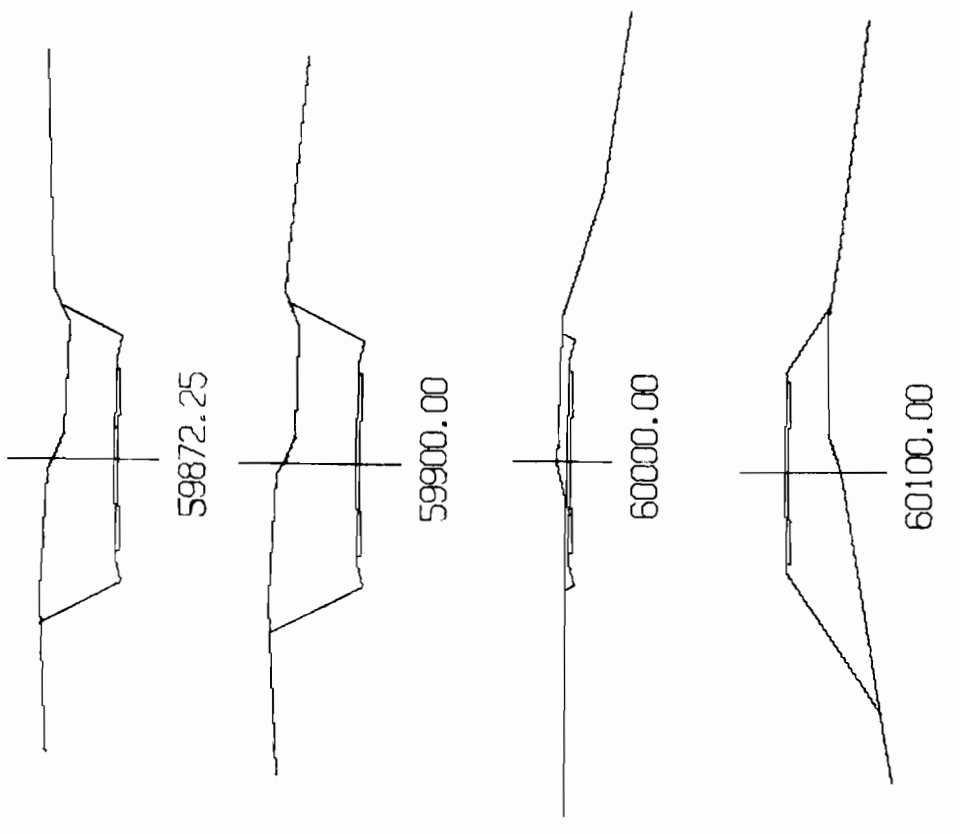

Figure 5—Computer Output Listings of Cross-Sections, and Corresponding Visual Representations.

Use of Digital Computers

The Section (Plans and Survey) is now using up to 30 hours per month of the Board's IBM 1620 computer time, as an aid to road design.

The techniques described in earlier Annual Reports are being more widely applied. The computer is used to an increasing extent for the more extensive geometric calculations associated with the larger urban design jobs being undertaken. It is used also for computations associated with various types of engineering surveys, and investigations.

Two techniques that have been further developed during the year are:

(i) Machine Plotting of Cross-Sections

It has been normal practice to provide output listings showing details of chainages, offsets from centre line, reduced levels, and cuts and fills, to replace the sheets of cross-section that otherwise would be supplied. People not familiar with these listings have met some difficulties with them because they do not present a clear visual picture of the conditions at each cross-section.

To overcome these difficulties a method of plotting by computer and incremental plotter has been developed. In the earthworks computations the input data is presented on punch cards, and similarly the output data can be obtained on punch cards. The input and output cards are sorted together in chainage sequence, and an edit programme is used to check the data. The edited

deck of cards is transferred on to magnetic tape at the C.S.I.R.O. laboratory at Monash University, and then sent to Canberra for processing and plotting on the C.S.I.R.O. C.D.C. 3600 computer, and attached incremental plotter. Plots are normally returned within about two days.

Typical computer output listings, and corresponding visual representations of cross-sections, are shown in Figure 5. Such visual representations have been found to assist greatly in understanding the plans.

(ii) Reduction of Stadia Cross-Sections

Manual reduction of cross-sectioning by stadia is a tedious operation. Use of a computer makes the reduction faster and much less laborious.

Cross-sectioning is carried out by a single centre line set-up, readings being taken at right angles to the centre-line. Readings are recorded as left, right, or on the centre line. The normal stadia book is used.

Input cards are punched directly from the stadia book, and after computer processing the output listings are cut and pasted into the stadia book as a permanent record of the results. A typical page of a stadia book, showing the field recordings, and the corresponding computer print-out is shown in Figure 6.

The reduced cross-section points can be presented on punch cards as input terrain for earthworks programmes if desired.

Tacheometric Survey of MARLOONDAH HIGHWAY

Locality MAXWELL'S HILL

Instr. No. _____ Stadia Const. _____ Vert Angle _____ Date _____ Surveyor _____

Inst. Const. _____ Dep. _____ Elev. _____ Field Book No. _____ Survey No. _____

Staff Stn.	Stadia Wires		Height on Staff	Bearing	Vert Angle	Hor Dist	Vert Comp	Diff. Hgt.		Coll	Reduced Level	Remarks and Sketch
	Upper	Lower						Rise +	Fall -			
1	3.96	2.49	3.72	L	+12° 00'						396.67	
2	4.46	3.43	3.95	L	+12° 00'					401.31		
3	4.48	3.72	4.10	L	+12° 00'							
4	5.09	4.62	4.85	L	+12° 00'							
5	4.99	4.73	4.86	L	+12° 00'							
6			4.64	±	0° 0'							
7	5.32	5.04	5.18	R	-13° 00'							
8	4.93	4.33	4.63	R	-13° 00'							
9	5.34	4.46	4.90	R	-13° 00'							
10	4.79	3.64	4.22	R	-13° 00'	136.7	31.56				365.76	
11	4.71	3.27	4.99	R	-13° 00'			35.55			389.86	
			11.45	182493	0° 0'							

Figure 6—Field Recordings in Stadia Book and Corresponding Computer Print-out.

Note the correction in "Height of Staff" column, Station 11. At this station, the height on the staff of 4.99 was fed into the computer (the computer compares the mean of the top and bottom wire readings with the centre wire reading as shown in the stadia book, i.e. for station 11, 3.99 against 4.99). Because the error was greater than 0.03 feet the computer programme would not reduce the level for this station (the programme checks for three items—wrong staff readings, column booking errors, and key punching errors). To save further programming and punching, the correction and level reduction were done manually.

3. TITLE SURVEYS AND PLANS

Title Surveys

A total of 428 survey plans were completed in 1966/67. The Board's title survey parties produced 379 of these, 88% of the total compared with 61% in 1965/66. The total includes 41 plans relating to by-pass roads.

The IBM 1620 computer processed 252,470 survey lines, an increase of approximately 52,000 lines over the previous year.

Drafting Section

A total of 567 Gazettal Plans were produced for the year, comprising 404 for Approving Orders in Council, 153 Declarations and 10 for Fixing of Alignments. In addition 1076 Transfer Documents were prepared for the Board's Estates Section.

Extensions are being made to the map produced in 1964 showing the Board's declared road system to the north-east of Melbourne. These extensions will cover all four sectors within 50 miles of Melbourne. The maps are required because maps of a sufficiently large scale to show the details of this system in the areas concerned, were not previously available.

Plan and Offset Printing

There was a general increase in production of 20% over 1965/66. The runs on the Solna and Multilith machines totalled 3,500,000 compared with 2,903,000, the Photo Direct camera produced 6,875 plates compared with 4,900, and plan production on the Dyeline machine was 104,021 prints compared with 101,054 last year. The Statfile operated for only part of the year through lack of an operator; for this period, however, production was higher than for the corresponding part of 1965/66. All collating, drilling and stapling is now being done in the section, and production of the various Board's manuals is proceeding satisfactorily.

4. RIGHT OF WAY

Right of Way Plans

Compilation of detailed records on the progress of land acquisition on by-pass roads, e.g. the Strathmore By-pass Road and the Tullamarine Freeway, is continuing. These records are plans indicating in a pictorial form the land tenure, access restrictions, restoration of access, land being leased, surplus land, etc., and other plans showing the authorized points of access to by-pass roads.

The compilation of right-of-way plans on portions of several declared main roads in the metropolitan area, such as Springvale Road, Doncaster Road and the Eltham-Yarra Glen Road, is progressing.

Planning Schemes

The examination of planning schemes on exhibition, and amendments to approved planning schemes, is occupying an increasing proportion of the time of senior engineers in the section. Further increases in the future are likely.

Highway Record Survey Plans

Highway record survey plans have been completed on 60 miles of the South Gippsland Highway (Welshpool to Sale), and 130 miles of the Princes Highway East (Oakleigh to Sale).

Strip maps have been compiled from aerial photographs on the following State highways:

Princes Highway East—Sections 3, 4, 5, 6—187 miles

Calder Highway—Sections 3, 4, 5—160 miles

Midland Highway—Sections 4, 5—76 miles

Western Highway—Sections 3, 4, 5,—144 miles

Bonang Highway—71 miles.

Odometer surveys for the re-positioning of mile posts have been carried out on the Princes Highway West, Sections 1 and 2, and the Mount Buller Tourists' Road.

MECHANICAL SUB-BRANCH

Design and Development

The following engineering design and system development work has been completed or is proceeding:

(a) Aggregate belt spreader.

The prototype of a new belt spreader capable of laying aggregate carpets up to twelve feet in width is almost complete. It is expected that this machine will be field tested during the 1967-68 season.

(b) Bitumen storage tanks.

Two electrically heated, insulated bitumen storage tanks each with a nominal capacity of 8000 gallons are in the course of erection at the Hamilton rail yard. The tanks are similar to two which have been in continuous use at the Horsham rail yard since late 1964.

(c) Sprayer test pit.

Considerable progress has been made with the construction of the Board designed bitumen sprayer test pit installation at Syndal. The majority of the mechanical equipment is on hand and building construction is in progress. The installation should be ready for use in 1968.

(d) Linemarking machine.

The design for a new medium size linemarking machine is nearing completion and most of its commercially available components are on hand. It will complement the large truck and trolley unit designed by the Board for high speed work on long sections and used since 1963. The smaller size of the new machine will make it more suitable than the large machine for use on winding mountain roads. It will be used for urban work also.

The machine will be self propelled and will carry 60 gallons of paint and 500 lbs. of glass beads. It will be able to produce broken or continuous single or double centre lines and edge lines. Centre lines will be painted at 8 miles per hour and edge lines at 6 miles per hour. Travel speed will be 20 miles per hour between jobs and a towing speed of 40 miles per hour will be permissible.

(e) Aggregate loaders.

Country Roads Board designed aggregate loaders have met with wide acceptance. With the Board's permission, a manufacturer has now built some forty machines with very minor departures from the Board's design, for private users and authorities other than the Board.

(f) Electronic data processing of plant information.

The Board approved in 1966 the processing of non-variable, and field operating, plant data on its IBM 1620 computer. The computer has already been used to compile the current plant catalogue, and the processing of field information is expected to commence early in the 1967-68 financial year. The results will greatly assist towards the more efficient and economical utilization of the plant fleet, e.g. by facilitating comparisons of operating costs of different makes and models of particular types of plant.

(g) Use of Critical Path Method.

The use of the critical path method for programming the various workshop operations for major overhauls of tractors, graders and similar plant has been found to be very valuable. The method will be used throughout the programme of plant overhaul to be undertaken by the Board's plant maintenance organization in the future.

Plant Acquisitions

The following major plant and machinery items of types not previously owned by the Board were acquired:

(a) Leyland Hippo Freightline model 20HT 18R heavy duty, three axle truck chassis. This is powered by a 200 h.p. 6 cylinder model 0-680 diesel engine. It is fitted with a 15 gear Fuller model RT 915 transmission, and Ergomatic tilt cabin and an Olding Garwood model 4 MB winch of 30,000 lb. maximum line pull capacity. The chassis is coupled to a Steco folding gooseneck, tandem axle semi-trailer low-loader of 26 tons maximum carrying capacity.

(b) Ford model D 600 patrol truck, fitted with tilt cabin suitable for seating four men side by side, and J. W. George steel tipping body of 4 cubic yards capacity. This truck is powered by a 130 h.p. 6 cylinder petrol engine.

(c) International model 21206 pneumatic tyred towing tractor powered by a 6 cylinder 120 h.p. turbo charged model DT 361 diesel engine through a 6 speed conventional transmission.

(d) Cranvel 3½ to 6 ton rear steer lifting and luffing crane based on a 60 h.p. Chamberlain Champion pneumatic tyred tractor fitted with a conventional transmission.

(e) Fiat model AT 7 crawler tractor powered by a 74 h.p. 4 cylinder diesel engine through a conventional 6 speed transmission and fitted with a hydraulically operated angle and tilt dozer.

(f) Case model 1150 crawler front-end loaders fitted with conventional or four-in-one type buckets of 1½ and 1 cubic yard capacity and Standen model 1000 RS rear mounted, hydraulically operated, swivel tyne rippers. These loaders are powered by a 105 h.p. 6

cylinder Case model 401 D diesel engine, through a 4 speed Terramatic torque-converter power-shift transmission providing independent drive to each track.

- (g) Conquip model 27 HC hydraulically operated front-end loader with a one cubic yard bucket capacity built on a 60 h.p. Chamberlain Champion pneumatic tyred wheel tractor. The tractor transmission combines a model 12 WQ Borg and Beck torque converter and a model AF2-72N Borg Warner Velvet Drive clutch pack and gear system, which provides cushioned immediate directional change in each of the three gears.
- (h) Superlift model 4 hydraulically operated front-end loader with a one cubic yard bucket built on a 60 h.p. conventionally geared Chamberlain Champion pneumatic tyred wheel tractor.
- (i) Warner & Swasey Gradall model G600A fully slewing multi-purpose hydraulic excavator, mounted on a 3 axle model GR6 x 4 pneumatic tyred chassis. This is fitted with a 10 speed Fuller manual transmission and powered by a 6 cylinder, 140 h.p. Continental model B 6427 petrol engine. The excavator equipment is powered through a hydraulic system by a 6 cylinder 90 h.p. model UD 282 International diesel engine.
- (j) Coates Crushroll towed 6-13 ton grid roller for compaction and soft stone reduction.
- (k) John Deere model JD 760 wheel tractor fitted with integrally mounted Goodwin-Duo-pactor hydraulically operated combination pneumatic tyred and steel wheel roller. In the maximum ballasted condition of the roller, the eight pneumatic tyred wheels can provide loads in excess of 5500 lb. each and the 84 inches wide steel wheel, a load of over 600 lb. per inch width. The roller is fitted with a hydraulically operated, rear opening, tipping body for easy ballast disposal. The servo steered tractor is powered by a 6 cylinder 143 h.p. diesel engine through an 8 speed synchromesh transmission. The tractor driving wheels and the pneumatic tyred roller wheels are fitted with power operated brakes.

- (l) Rolba model R-400 rotary snow plough on a 4 wheel all-wheel drive, rear steered, pneumatic tyred tractor unit, powered by a 4 cylinder, 80 h.p. air cooled Deutz model A 4L514 diesel engine through a 4 speed hydrostatic transmission.

The snow plough can clear up to 700 tons of snow hourly, from a path 6 ft. 11 in. wide. The cleared snow is ejected on either side of the machine, which has working speeds of up to 13 miles per hour and travel speeds of up to 19 miles per hour. The plough cabin is heated.

- (m) Rolba model R-1500 rotary snow plough on a 4 wheel all-wheel drive, rear steered, pneumatic tyred tractor unit which is powered by a 6 cylinder, 145 h.p., air cooled Deutz model F6L-714 diesel engine through a conventional 12 speed gear box which provides working speeds from 0.25 to 20 miles per hour and travel speeds of up to 25 miles per hour.

The snow cutting and ejector system is capable of removing up to 1800 tons of snow per hour from a path 8 ft. wide, ejecting the snow to each side. This system is powered by a 12 cylinder 230 h.p. air cooled Deutz model A12L-714 diesel engine through a 2 speed gear box. The cab is heated.

Apprentice Centre

The newly established Apprentice Centre completed its first year of operation and provided first year motor mechanic apprentices with a carefully compiled training in practical and theoretical matters.

The apprentices worked on engines and other machinery provided by the Board, but were not admitted to the workshops during their first year. The apprentices who completed the year in the Apprentice Centre achieved better scholastic results than those of earlier apprentices, and on their admittance to the workshops showed themselves to be better qualified than earlier second year apprentices.

ADVANCE PLANNING

Road Needs Survey

In accordance with the decision of the National Association of Australian State Road Authorities that all the Authorities should co-operate and undertake a road needs survey covering the period 1 July 1969 to 30 June 1974, work proceeded on the preparation of a specification for the conduct of the survey in rural and provincial urban areas.

Agreement was obtained with the Commonwealth Bureau of Roads on basic assumptions and premises, and the general specification prepared

by a sub-committee of the Advance Planning Committee of NAASRA was approved by NAASRA. The Commonwealth Bureau of Roads produced guide lines for the conduct of investigations in capital city areas, and organized a briefing at the Board's Head Office of representatives of all Authorities in the techniques and procedures desired.

The present Commonwealth Aid Roads Act expires 30th June 1969. It is intended that survey results will be available in 1968. This will permit consideration of the results before the Commonwealth Government formulates the provisions of the next Act.

ENGINEERING COMPUTER SECTION

The Board's computer installation operated satisfactorily during the year, and no changes were made to the equipment being used. The computer configuration consists of:

IBM 1620 Central Processing Unit Model 1
 IBM 1622 Card Read-Punch
 IBM 1622 Core Storage Unit
 IBM 1443 On-line Printer
 IBM 082 Card Sorter

The computer has a direct access memory of 40,000 digits. This limitation, together with the lack of secondary storage, and the volume of work to be processed has prompted investigation into the desirability of purchasing or renting improved or additional equipment.

No changes have been necessary to the data preparation equipment being used. The three IBM key punches and two IBM card verifiers which are on rental have coped with the steadily increased quantity of work. Occasional minor delays during peak periods occurred, but the delays were generally within acceptable limits.

Use of the Board's Computer during 1966/67

(a) Use by Board's staff

The total computer time used during the year by sections of the Board is shown in Table 10. Here, the term "production" refers to the processing of design problems and other directly useful work; "development" refers to writing and testing of new computer programmes, and to necessary modifications to existing programmes.

TABLE 10—IBM 1620 COMPUTER USAGE BY BOARD'S STAFF

User	Production	Development	Total
	hours	hours	hours
Bridge Sub-branch	389	166	555
Plans and Survey Section	338	21	359
Title Survey Section	137	—	137
Materials Research Division	35	25	60
Traffic and Location Section	41	28	69
Advance Planning Division	83	34	117
Computer Section	89	252	341
Dandenong Division	17	—	17
Asphalt Division	7	—	7
Accountant's Branch	41	5	46
Secretary's Branch	50	42	92
Totals for 1966/67	1,227	573	1,800

Additional details of the work processed and the programming undertaken during the year are provided elsewhere in this report.

(b) Use by Other Bodies

A number of other Government departments and instrumentalities made use of the Board's computer installation during the year, viz.

Department of Lands and Survey
 Department of the Army (Survey)
 State Rivers and Water Supply Commission
 Commonwealth Department of Works
 Australian Road Research Board
 Melbourne Metropolitan Transportation Study

These bodies used a total of 356 hours of computer time.

(c) Trends in Computer Usage

The total computer time used for productive work increased by 17%, and the time for programme development increased by 16%, above the 1965/66 level. These percentage increases are smaller than those for the previous year, due to the more effective use of the computer following installation of the IBM 1443 on-line printer in May, 1966. The increase in processing efficiency was reflected in a sharp reduction in usage of computer time in the first quarter of 1966/67. After October 1966, the daily workload again steadily increased, and at June 1967 the overall rate of increase was approaching 30% per annum.

Extended single shifts averaging 10½ hours per day were worked in the latter part of the year, and it will be necessary to introduce full two-shift operation during 1967/68.

Computer Programming

The Section continued to provide advice and assistance to other members of the staff engaged in the development of computer programmes, some of which are listed below. Further references to these programmes will be found elsewhere in this report.

The Bridge Sub-Branch were assisted in the development of a computer-aided method of preparing specifications for bridgeworks. A programme to calculate details of horizontal alignments and offsets was written for the Plans and Survey Section. A report-generating programme was developed for the Materials Research Division to assist in the presentation of concrete cylinder test results. Additional programmes were written for the Mechanical Sub-Branch Plant Records System, and a complete plant catalogue was printed from offset masters prepared by the on-line printer. Four supplementary programmes to produce summaries and annual statistics of sprayed bituminous roadwork were programmed for the Asphalt Division. The Section also co-operated with the Secretary's Branch in the development of a comprehensive Land Acquisition Information System.

SAFETY

A nett decrease of 21·6 per cent in injuries to Board's staff at work was observed for the latter half of 1966/67 compared with the same period in 1965/66. (The position of Board's Safety Officer was vacant during part of the first half of 1966/67 and satisfactory records of injuries during that period are not readily available). Details of the injuries are set out in Table 11 (fatalities, 6 in 1966/67 and 4 in 1965/66, are excluded).

TABLE 11—INJURIES TO BOARD'S EMPLOYEES

Type of Injury	Periods under Comparison		Changes from 1966 period to 1967 period	
	1/1/66-30/6/66	1/1/67-30/6/67	Decrease	Increase
Multiple injuries ..	7	2	5	—
Head injuries	14	10	4	—
Burns and scalds ..	20	16	4	—
Fractures	18	9	9	—
Lacerations and wounds	40	44	—	4
Back strains	84	38	46	—
Sprains and strains ..	30	21	9	—
Foreign body in eyes ..	40	9	31	—
Miscellaneous	95	124	—	29
Totals	348	273	Nett decrease = 75	

For the above periods, the relative frequency of accidents in which Board's employees were involved decreased from 95·6 to 67·5 accidents per million man hours worked; and the relative severity of accidents decreased from 789 to 483 days lost per million man hours worked. Efforts are being directed to maintain these apparent trends.

The causes of a number of the accidents which occurred were investigated, with a view to preventing recurrences of the accidents.

The importance of safe practice was stressed through conferences, including lectures and films, with engineers, overseers, foremen, gangers and other staff. Particular stress was placed on the importance of safe lifting practice, with the object of reducing the number of lost time injuries resulting from incorrect lifting practices.

Practical demonstrations in resuscitation and fire fighting practice were held at the Board's Head Office. Further training on the use of hoses and extinguishers is proposed.

STAFF TRAINING

Selected members of the Chief Engineer's Branch attended the following training courses and conferences during 1966/67:

External Courses

- Civil Engineering Construction Management Course—University of New South Wales.
- Seminar—Effective Top Management—Dr. Koontz—Beckingsale and Company.
- Seminar—Managing for Tomorrow—Professor P. F. Druckner—Victorian Employers' Federation.
- Superintendents of Works Conference—Local Government Engineers' Association of Victoria.
- Introduction to Industrial Relations—Society for the Advancement of Leadership and Training in Australia.
- Overseers' Course—Royal Melbourne Institute of Technology.
- Advanced Bridge Design—Cement and Concrete Association of Australia.
- Introduction to Corrosion Technology—Royal Melbourne Institute of Technology.
- 885 Network Analysis Course—Australian Institute of Management.
- Annual Welding Convention—Australian Welding Convention.
- Symposium on Specification and Control of Concrete—Cement and Concrete Association of Australia.
- Concrete Technology and Practice—Royal Melbourne Institute of Technology.
- Fabrication and Welding of USS T1 Constructional Alloy Steels—Mr. D. J. Snyder—Norman W. Hutchinson and Sons Pty. Ltd.
- Symposium on Design Construction and Corrosion—Australian Corrosion Association—University of Melbourne.
- Scaffolding Course—Royal Melbourne Institute of Technology.
- Geological Society of Victoria—Meeting.
- Viscosity and Viscoelastic Measurement and Instrumentation—University of Melbourne.
- Filter Design—University of Melbourne.
- Traffic Planning and Control Course—University of New South Wales.
- Seminar—Traffic Engineering—University of Melbourne.
- Australian Study Week on Road Safety Practices—Institution of Engineers, Australia—University of Melbourne.
- Transport System Problems—Lecture by Dr. Robert Herman of the U.S.A. under the auspices of Monash University.
- Tenth Survey Congress—Institution of Surveyors, Australia.
- Programmed Computing for Surveyors—University of Melbourne.
- Fluid Power Courses—Royal Melbourne Institute of Technology.
- Mobile and Mechanical Equipment Hydraulics—Royal Melbourne Institute of Technology.
- Conference—Institution of Automotive and Aeronautical Engineers.
- Passenger Car Steering and Suspension Systems—Institution of Automotive and Aeronautical Engineers.
- Symposium on Experimental Stress Analysis—Institution of Engineers, Australia.
- Experimental Stress Analysis, and Design for Torsion—Royal Melbourne Institute of Technology.
- Symposium on Semi-Automatic CO₂ Gas Shielded Processes for Welding Steel—Australian Welding Institute.
- Maintenance Management Course—W. D. Scott and Co. Pty. Ltd.
- Selected Topics in Mathematics—University of Melbourne.
- Visit to Tullamarine Airport—Commonwealth Department of Works.
- Explosives Course—S.E.C.V.
- Conference at Hobart—Institution of Engineers, Australia.
- Operations Research, Some Techniques and Applications—Institute of Industrial Engineers.
- Symposium on Safety—Safety Engineering Society of Australia.
- Seminar on PERT and CPM—Control Techniques Pty. Ltd.
- Fortran Programming Course—I.B.M. Australia Pty. Ltd.—University of Melbourne.

Internal Courses

Course for Administrative Personnel.

Training in Communication.

Overseers' and Gangers' Conference, Warrnambool Division.

Crane Appreciation Course—held at various Divisions.

Fiat Mobile Service School—held at Syndal.

Hydraulic System of John Deere Tractors—Intrac Pty. Ltd.—held at Syndal.

Kinetic Lifting Courses.

Traffic and Location Section—Staff Training.

Assistance on training matters was given to other organizations. These included the Department of External Affairs (Colombo Plan Fellows, Thai engineers and Asian students) and the Victorian Education Department (Technical Teachers Scheme).

MANUALS

The position on preparation of manuals for use by the Board's engineering staff is as follows:

- (a) The "Road Design Manual" and the "Manual of Lifting Gear" were published during 1966/67.
- (b) The following manuals should be published early in 1967/68:

Road Drafting Manual

Engineering Survey Manual

Title Survey Manual

- (c) A draft of the "Manual for Engineers" is under consideration by the Board.

- (d) The revision of the standard specifications for roadworks and the preparation of "Notes on the Standard Specifications for Roadworks" are well advanced. Preparation of the "Manual for Guidance of Municipal Engineers", and the "Freeway Design Manual" is proceeding.

- (e) Staff of the Board co-operated with staff from other State Road Authorities in the revision of the 1961 edition of "Specifications for Highway Bridge Construction".

PUBLICATIONS

The following papers were presented during 1966/67, in connection with the Board's engineering work:

Paper	Author
<i>Investigation of Landslides Affecting Some Victorian Roads</i> Presented at the Third Conference of the Australian Road Research Board, Sydney, September 1966.	A. H. Bartlett, B.Sc., A.M.Aust.I.M.M.
<i>Resistivity Method for Location of Sand and Gravel</i> Presented at the Third Conference of the Australian Road Research Board, Sydney, September 1966.	A. H. Bartlett, B.Sc., A.M.Aust.I.M.M. J. N. Foote, B.Sc., Stud. Aust. I.M.M.
<i>Search for Gravel using Mapping, Photogrammetric and Geophysical Techniques</i> Presented at the Twenty-third Conference of Municipal Engineers, Kew, February, 1967.	A. H. Bartlett, B.Sc., A.M.Aust.I.M.M. J. N. Foote, B.Sc., Stud. Aust. I.M.M.
<i>Developments in Priming, Primer Seals and Available Materials</i> Presented at the Twenty-third Conference of Municipal Engineers, Kew, February 1967.	S. B. Deany, C.E., A.M.I.E. Aust., A.V.I.S.
<i>Maintenance and Repair of Traffic Signs</i> Presented at the Twenty-third Conference of Municipal Engineers, Kew, February 1967.	K. D. Freeman, Dip. C.E., A.M.I.E. Aust.
<i>Pavement Marking Procedures and Standards</i> Presented at the Twenty-third Conference of Municipal Engineers, Kew, February 1967.	K. D. Freeman, Dip. C.E., A.M.I.E. Aust.
<i>Snow Removal—Outline of Procedures</i> Presented at the Twenty-third Conference of Municipal Engineers, Kew, February 1967.	T. M. Glazebrook, Dip. C.E., C.E., A.M.I.E. Aust.
<i>Snow Removal—Methods and Equipment Employed by the Country Roads Board of Victoria and the Snowy Mountains Hydro-Electric Authority</i> Presented at the Institution of Engineers Conference, Hobart, March 1967.	T. M. Glazebrook, Dip. C.E., C.E., A.M.I.E. Aust. in conjunction with G. A. McRae, B.E., A.M.I.E. Aust., of the Snowy Mountains Hydro-Electric Authority.

- Road Development in the Heytesbury Settlement with Particular Reference to Technical Aspects of Design and Construction*
Presented at the Third Conference of the Australian Road Research Board, Sydney, September 1966. J. A. F. Glenn, Dip.C.E., C.E., A.M.I.E. Aust.
- Effects of Highway Design*
Presented at the Australian Study Week on Road Safety Practices, arranged by the Institution of Engineers, Australia, in conjunction with the Australasian Postgraduate Federation in Medicine, Melbourne, May 1967. N. S. Guerin, B.C.E., C.E., Cert.H.T.(Yale), A.M.I.E. Aust., A.M.I.T.E.
- Compaction of Road Subgrades and Pavements*
Presented at the Twenty-third Conference of Municipal Engineers, Kew, February 1967. L. M. Jones, B.C.E., C.E., A.M.I.E. Aust., Dip. Highway Engineering and Traffic Studies (Durham).
- Lime Stabilization of Clay Subgrades*
Presented at the Twenty-third Conference of Municipal Engineers, Kew, February 1967. K. G. E. Moody, B.C.E., M. Eng.Sc., Ph.D. (Ill.), A.M.I.E. Aust.
- Stress Strain and Displacement Distributions in Cross-Anisotropic and Two-Layer Isotropic Elastic Systems*
Presented at the Third Conference of the Australian Road Research Board, Sydney, September 1966. P. Mullholland, B.E., Grad. I.E. Aust., in conjunction with C. M. Gerrard, B.E., M. Tech., Grad. I.E. Aust., Australian Road Research Board Fellow, University of Melbourne.
- Safety for Roadworkers*
Presented at the Twenty-third Conference of Municipal Engineers, Kew, February 1967. W. F. Neville, C.E., A.M.I.E. Aust.
- Compaction Control of Bituminous Concrete by Air Permeability Measurement*
Presented at the Third Conference of the Australian Road Research Board, Sydney, September 1966. O. T. O'Flynn, B.Sc., A.R.A.C.I.
- Use of the Roughometer for Road Roughness Studies*
Presented at the Third Conference of the Australian Road Research Board, Sydney, September 1966. J. H. Pittard, B.C.E., Grad. I.E. Aust.
B. L. Head, B.C.E., B.C.E., A.M.I.E. Aust.
- The Use of "Soft Sandstone" as Pavement Material in the Wimmera*
Presented at the Third Conference of the Australian Road Research Board, Sydney, September 1966. A. J. Pryor, B.C.E., Dip. C.E., A.M.I.E. Aust.
- High Strength Reinforcement in Reinforced Concrete Beams Subject to Repeated Loading at Room and Sub-Zero Temperatures*
Presented at a "Symposium on Concrete Structures"—Sydney, May 1967: arranged by the Institution of Engineers, Australia
Paper will be printed in the Civil Engineering Transactions of the Institution. T. H. Russell, M.Eng.Sc., B.C.E., A.M.I.E. Aust.,
J. R. Webber, B.E., Grad. I.E. Aust.
- Low Volume Rural Intersections*
Presented at the Twenty-third Conference of Municipal Engineers, Kew, February 1967. R. T. Underwood, M.E., Dip. T. & R.P., C.H.T.(Yale), C.E., A.M.I.E. Aust., M.A.P.I., A.M.I.T.E.
- Corrosion in Relation to Bridge Design and Construction*
Presented at a "Symposium on Design Construction and Corrosion" arranged by the Victorian Branch of the Australasian Corrosion Society. B. A. Watson, B.E.(Hons.), A.M.I.E. Aust.

The following issues of "Engineering Notes" were published:

- No. 81—Setting Out Bridge Works
- No. 82—Crane Jib Attachment for Front End Loaders
- No. 83—Modification of Front End Loader to Load Timber Debris
- No. 84—Field Repair of Bullet Holes in Plywood Signs.

One issue of "Construction News" was published, containing five items on various topics.

STAFF

Total staff of the Chief Engineer's Branch was 940 at 30th June, 1967.

Total Board's funds expended by the Board on direct work and by municipalities on works financed partly by the Board totalled \$63,238,000 for the financial year 1966/67.

The work has increased both in volume and complexity with consequent heavy demands on the staff. These demands have been met capably and

I wish to thank the staff for the part played by them.

Mr. R. C. Jones, C.B.E., died during the year. He had made a valuable contribution to the work of the Board over a period of 27 years.

Mr. J. R. Galbraith, Divisional Engineer, Metropolitan Division, retired after 18 years of valuable service, in April, 1967.

H. S. GIBBS,
Chief Engineer.